

Rivera 44
Art. Nr. 4416802
1/15

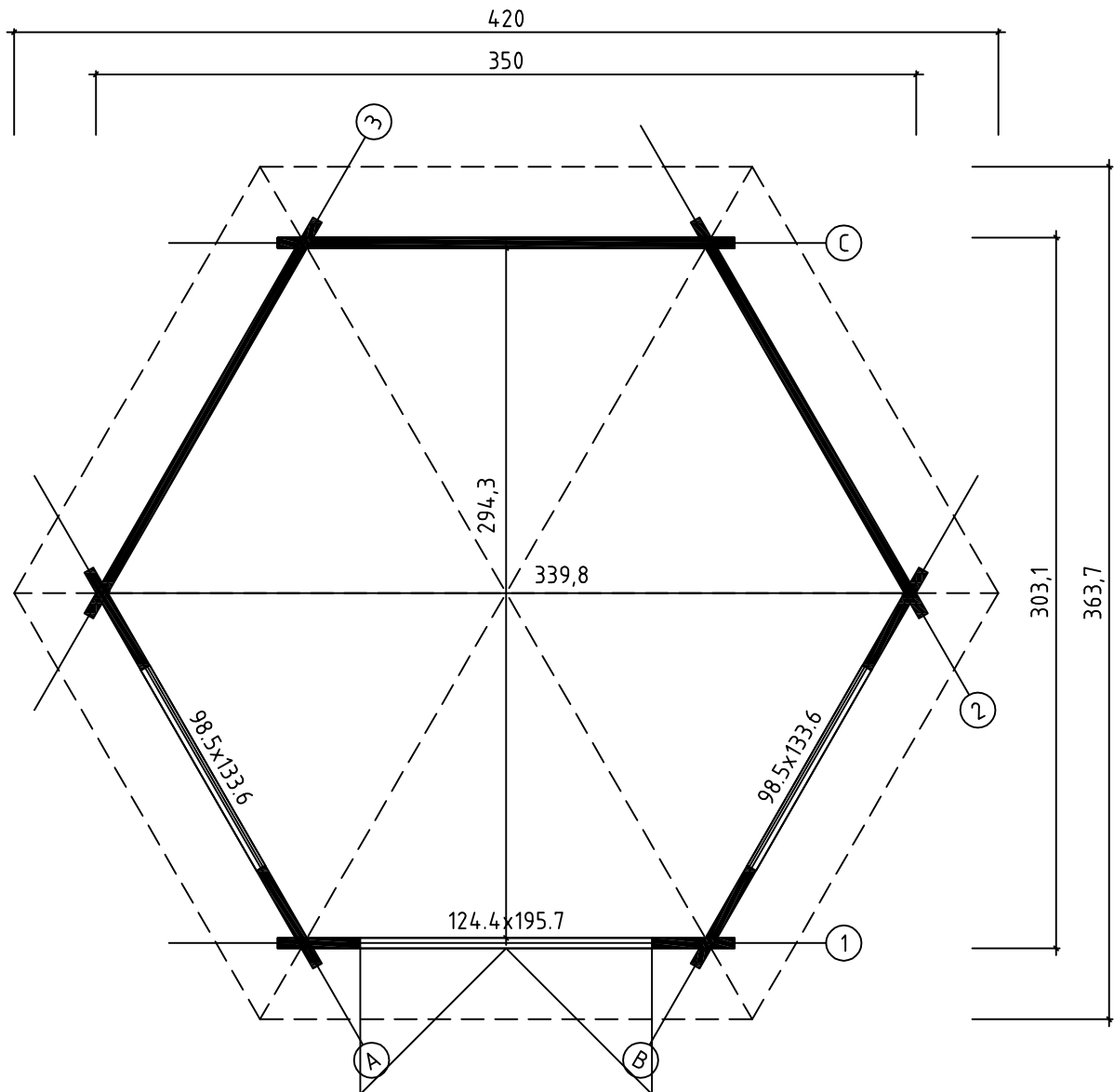

Art.Nr. 4416802

GROUNDPLAN - GRUNDPLAN - PLAN DE MASSE



Art.Nr. 4416802

FOUNDATION - FUNDAMENT - FONDAZIONE

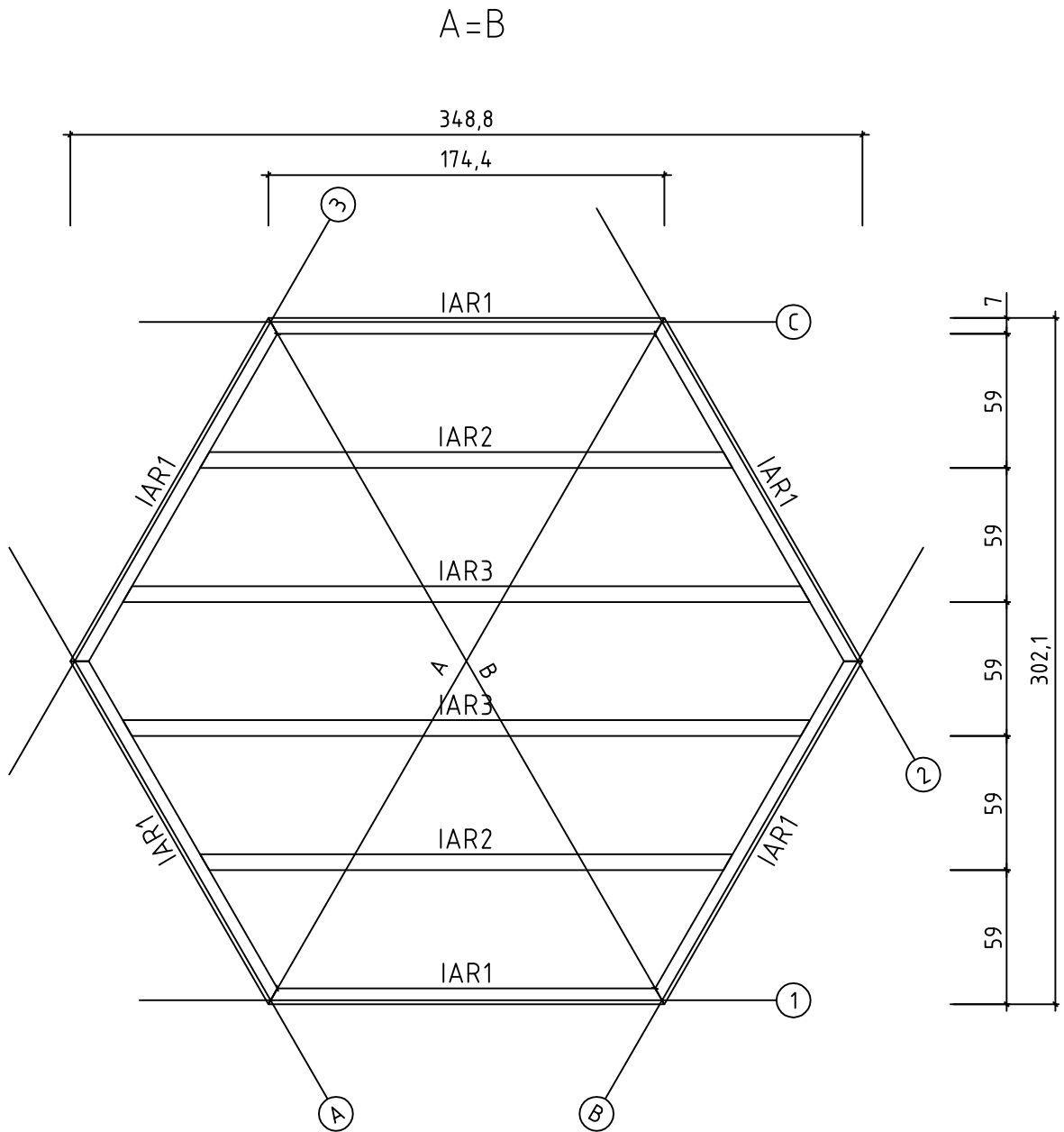

Art.Nr. 4416802

FLOOR BOARDS - FUSSBODENBRETTER - PLAN POSE PLANCHER

A - A

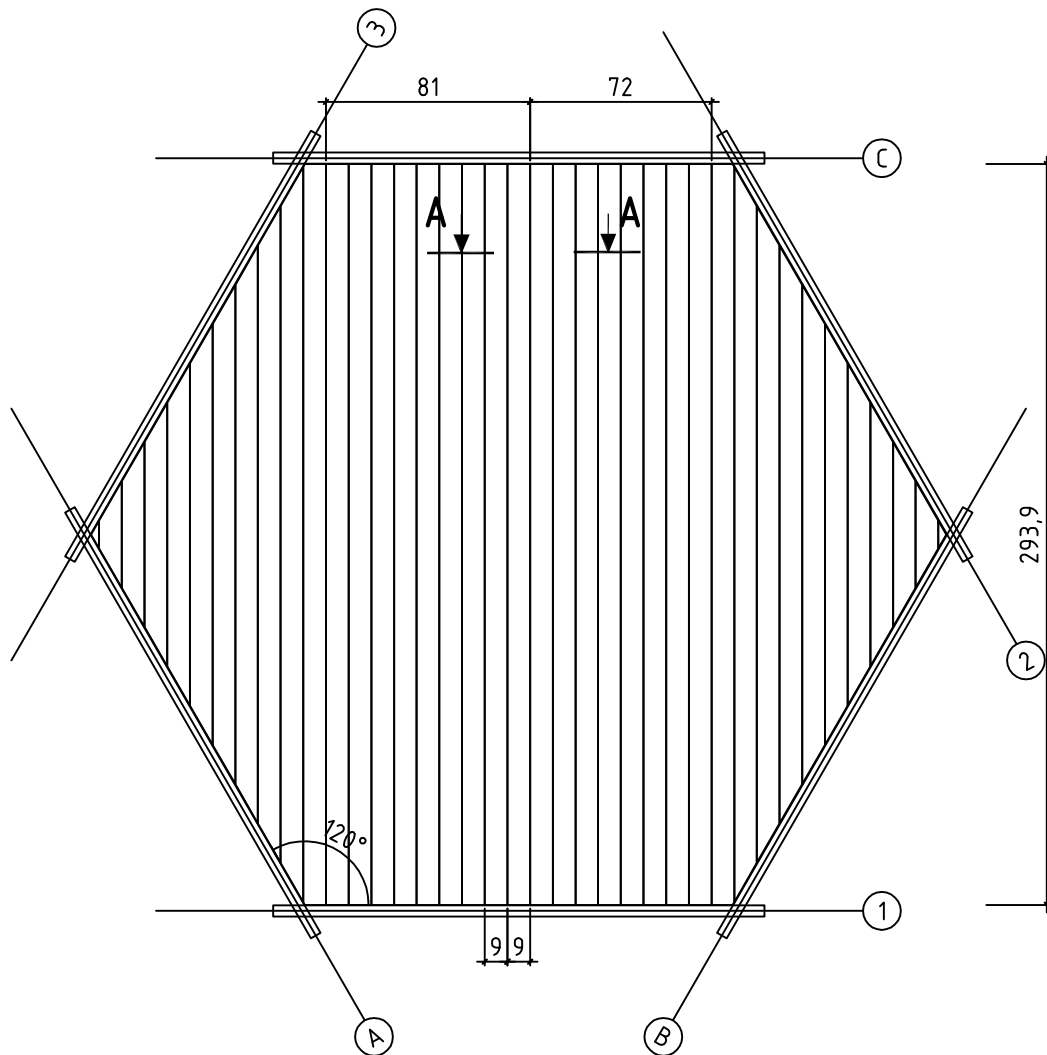
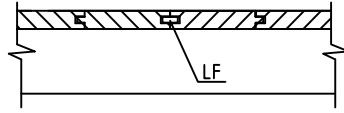

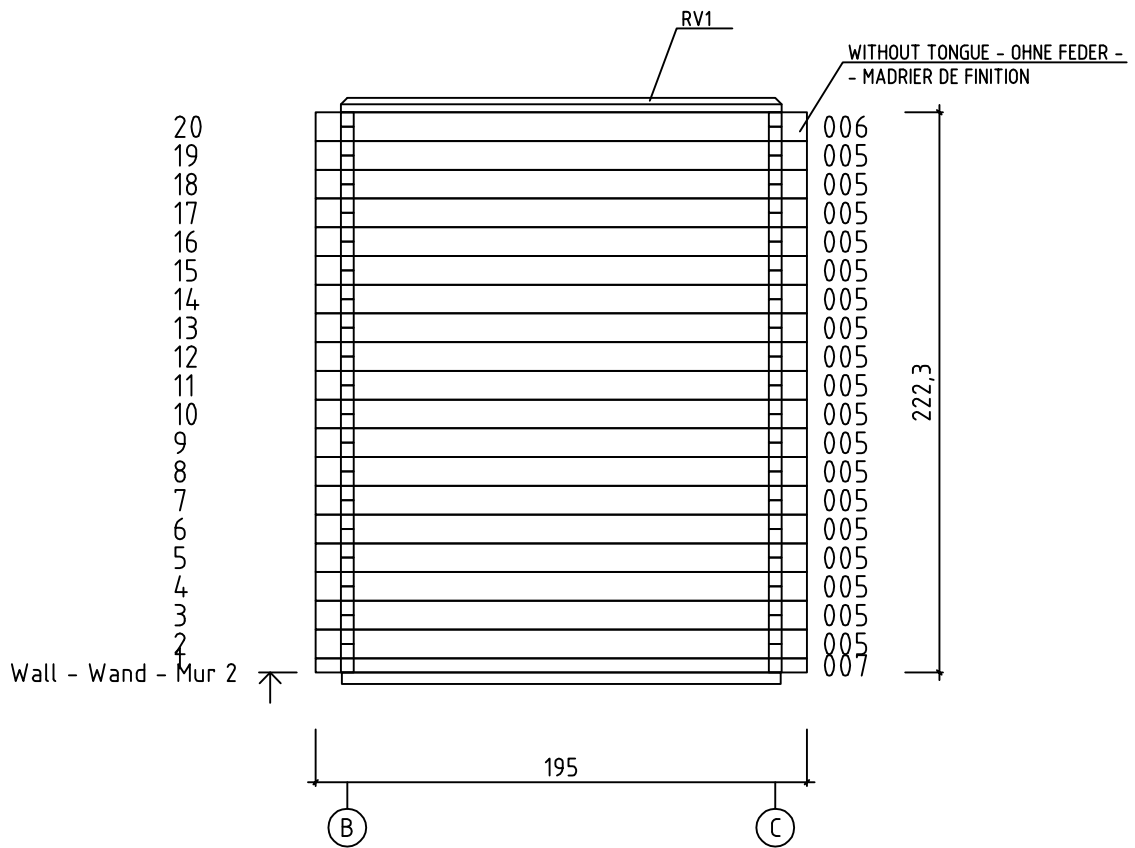
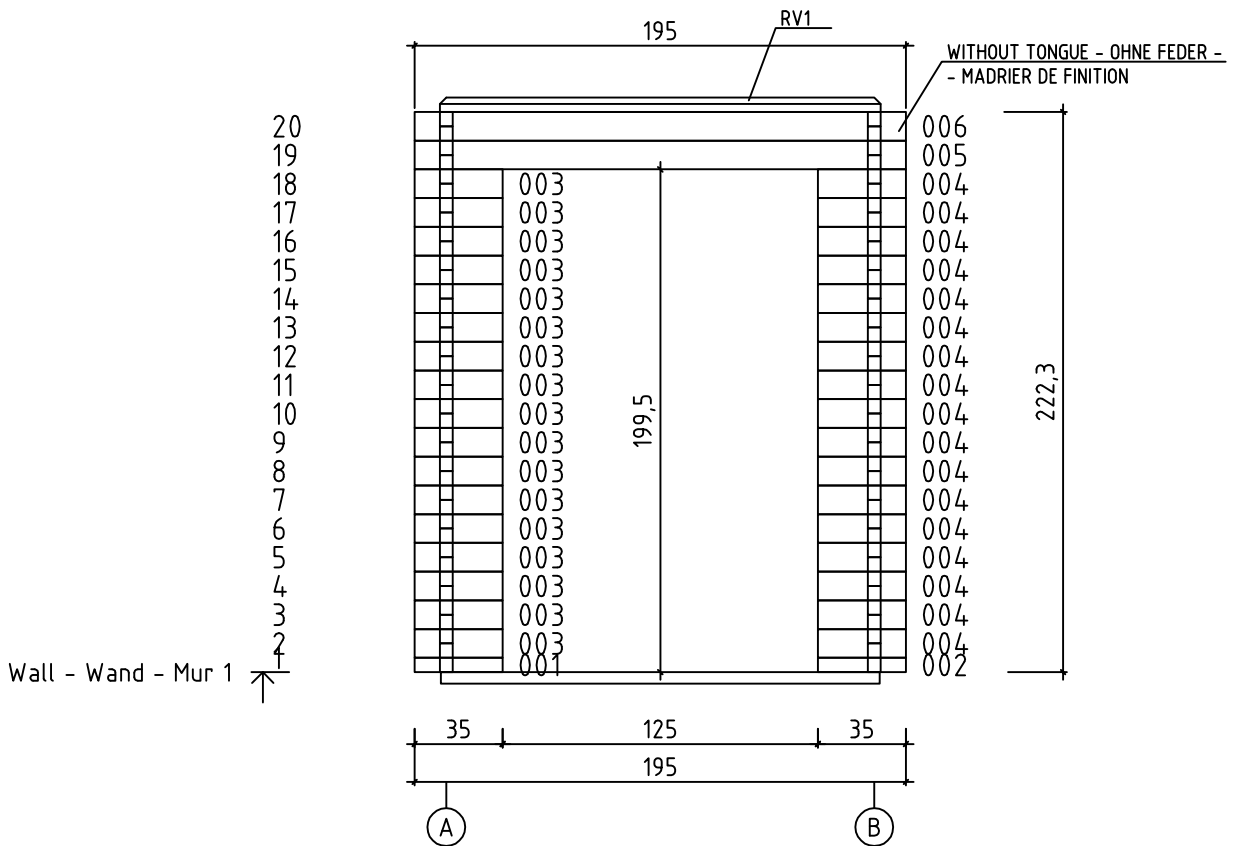

Art.Nr. 4416802

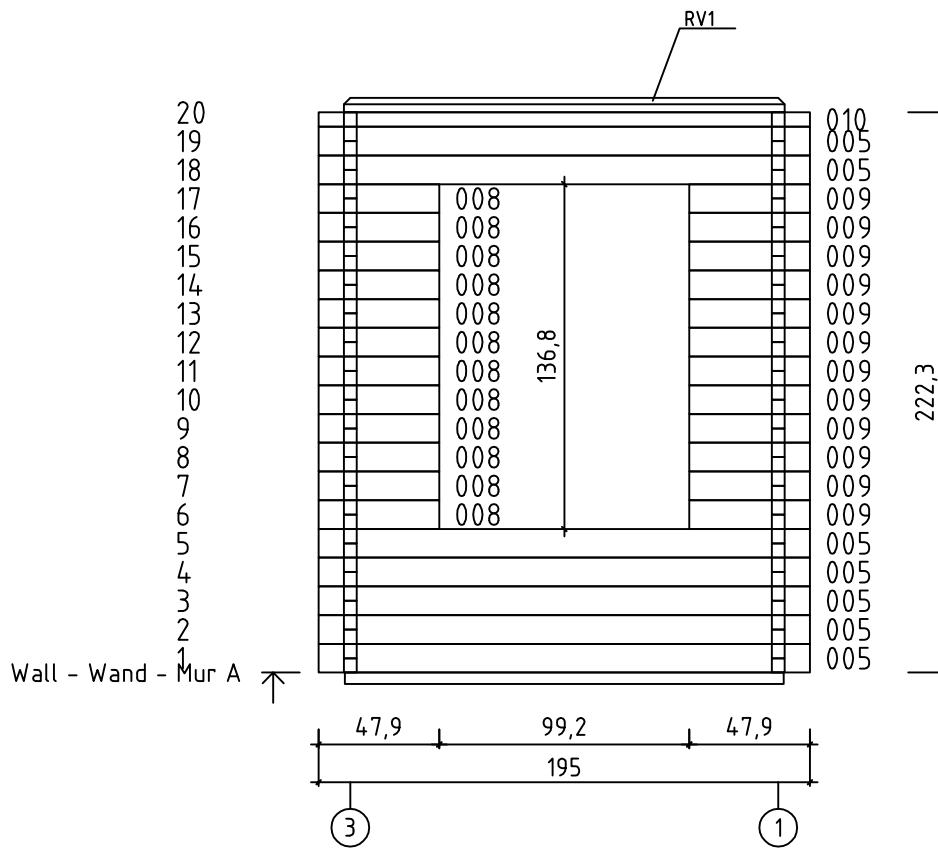
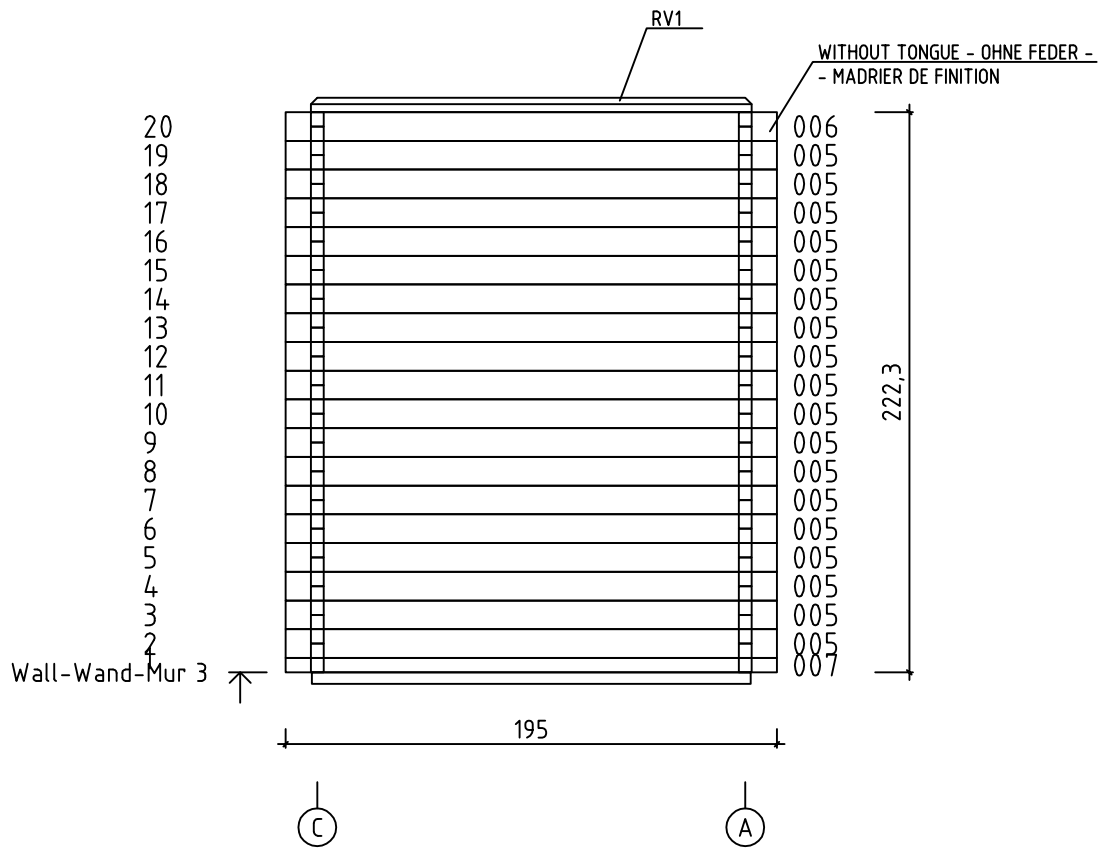

Art.Nr. 4416802

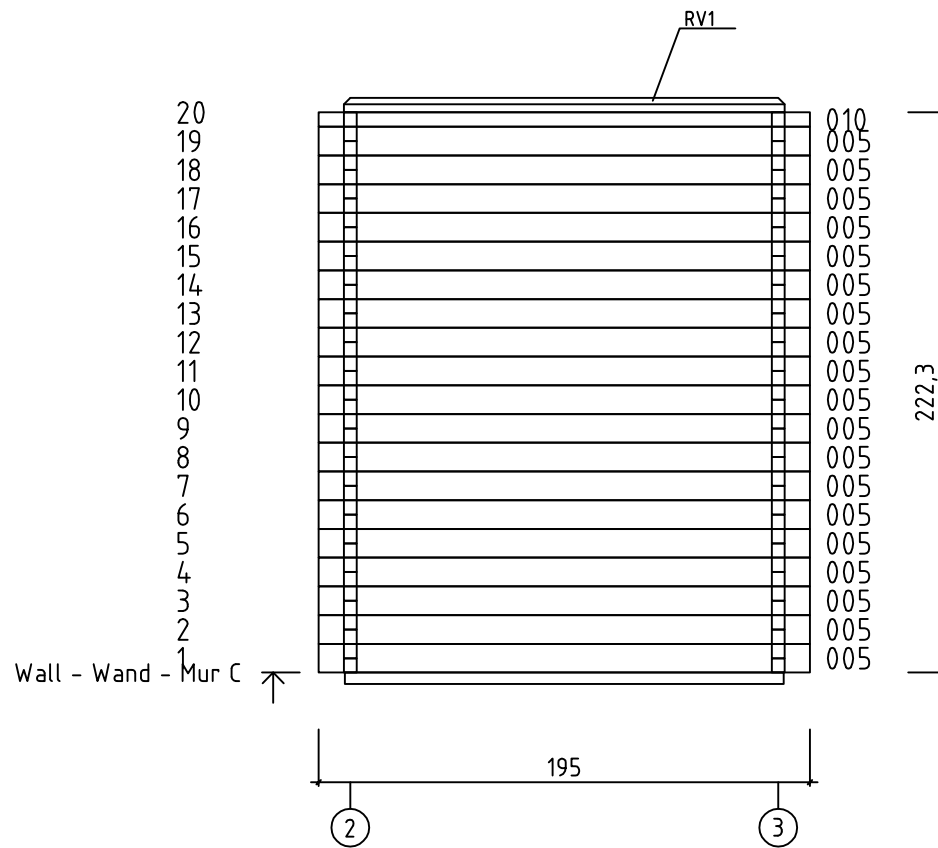
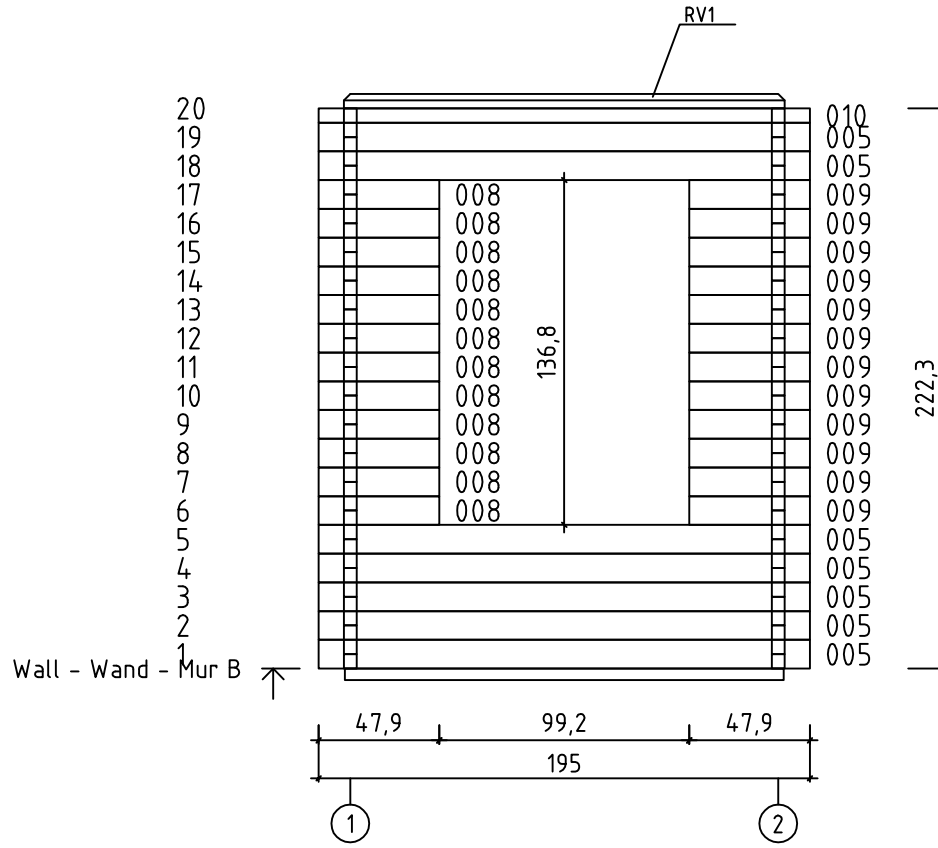

Art.Nr. 4416802

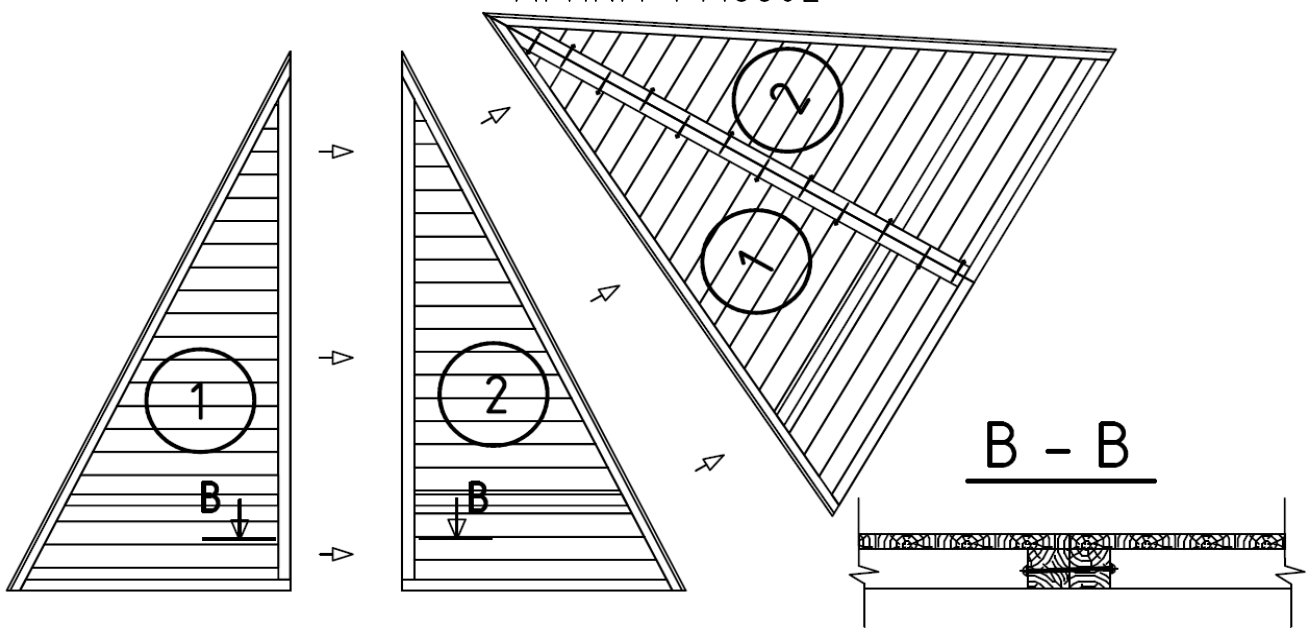

ATTACH LEFT AND RIGHT (1 & 2) ROOF PANELS TOGETHER, USING 2 SCREWS HS1 (12 PCS TOTAL) AT THE LOWEST PART (B-B). THEN AT REGULAR INTERVALS USING THE REMAINING 10 SCREWS, ATTACHING THEM ON ALTERNATING SIDES.

VERBINDEN SIE DIE LINKE UND RECHTE (1 & 2) DACHFLÄCHE MIT DEN SCHRAUBEN HS1 (12 STÜCK INSGESAMT) BEGINNEND AN DER TIEFSTEN STELLE (BB). DANN IN REGELMÄßIGEN ABSTÄNDEN DIE RESTLICHEN SCHRAUBEN VON BEIDEN SEITEN BIS HIN ZUR SPITZE ANBRINGEN.

ASSEMBLER LES PANNEAUX DE TOIT 1 ET 2 AVEC LES VIS (HS1 - 12 VIS AU TOTAL) EN LES RÉPARTISSANT À INTERVALLE RÉGULIER COMME LE MONTRE LE DESSIN CI-DESSOUS.

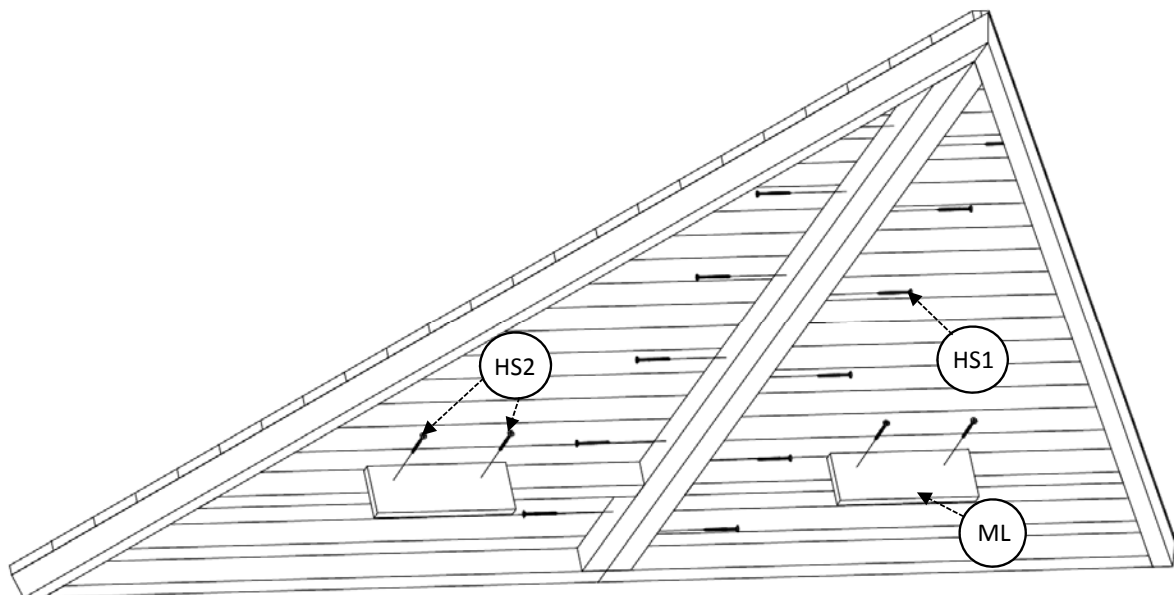

USING 2 SCREWS (HS2) ATTACH ML TO THE LOWER PART CROSS BATTEN ON THE UNDERSIDE OF THE ROOF PANEL (THESE ARE TEMPORARY SUPPORTS).

MIT DEN ZWEI SCHRAUBEN (HS2) BEFESTIGEN SIE DIE KOMPONENTE ML AUF DEM UNTEREN RAHMENTEIL. HIERBEI HANDELT ES SICH UM STÜTZEN ZUR BEFESTIGUNG DER DACHFLÄCHEN.

POUR LA MISE EN PLACE DES PANNEAUX DE TOIT, VEUILLEZ VISSER TEMPORAIREMENT LES DÉTAILS ML AUX TRAVERSES INTERMÉDIAIRES AVEC LES 2 VIS (HS2) POUR CHAQUE DÉTAIL ML. UNE FOIS LA MISE EN PLACE DE LA TOITURE TERMINÉE, VOUS POURREZ LES ENLEVER.

Art.Nr. 4416802

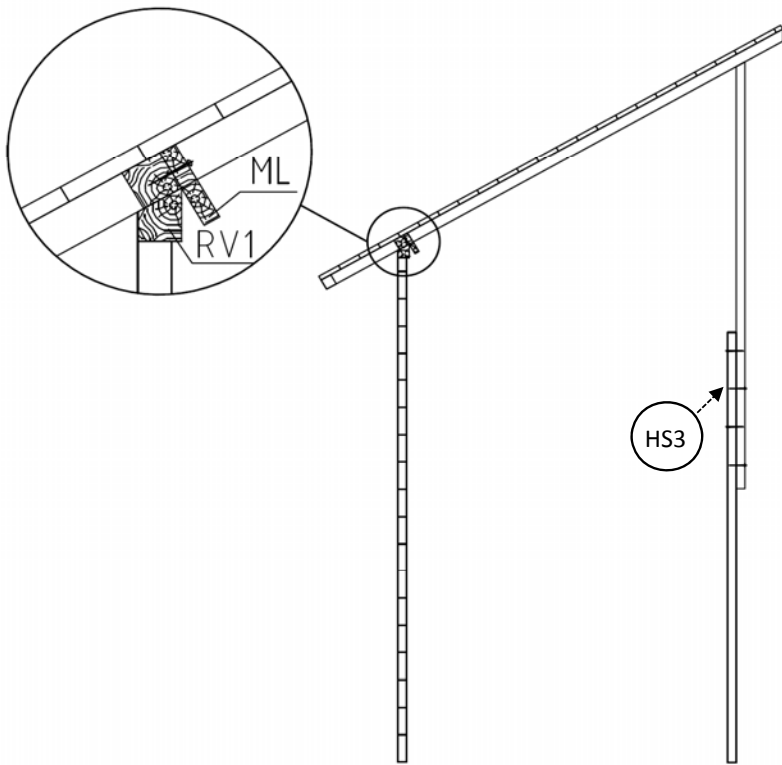

ATTACH TOGETHER PARTS AB SO THAT THE ENTIRE LENGTH IS 3100 MM USING 4 SCREWS PROVIDED HS3. THIS IS A TEMPORARY SUPPORT TO HELP YOU MOUNT THE ROOF.

VERBINDEN SIE DIE BEIDEN KOMPONENTEN A & B MITTELS DER VIER SCHRAUBEN HS3 MITEINANDER. SO DASS DIE LÄNGE 3.100 MM BETRÄGT. HIERBEI HANDELT ES SICH UM EINE TEMPORÄRE STÜTZE ZUR INSTALLATION DER DACHFLÄCHEN.

POUR LA MISE EN PLACE DES PANNEAUX DE TOIT, VEUILLEZ VISSER AVEC 4 VIS (HS3) LES SUPPORTS DE MAINTIEN DE TOIT AB ENSEMBLE DE TELLE SORTE À OBTENIR UN POTEAU D'UNE HAUTEUR TOTALE DE 3 100 MM. UNE FOIS LA MISE EN PLACE DE LA TOITURE TERMINÉE, VOUS POURREZ L'ENLEVER.

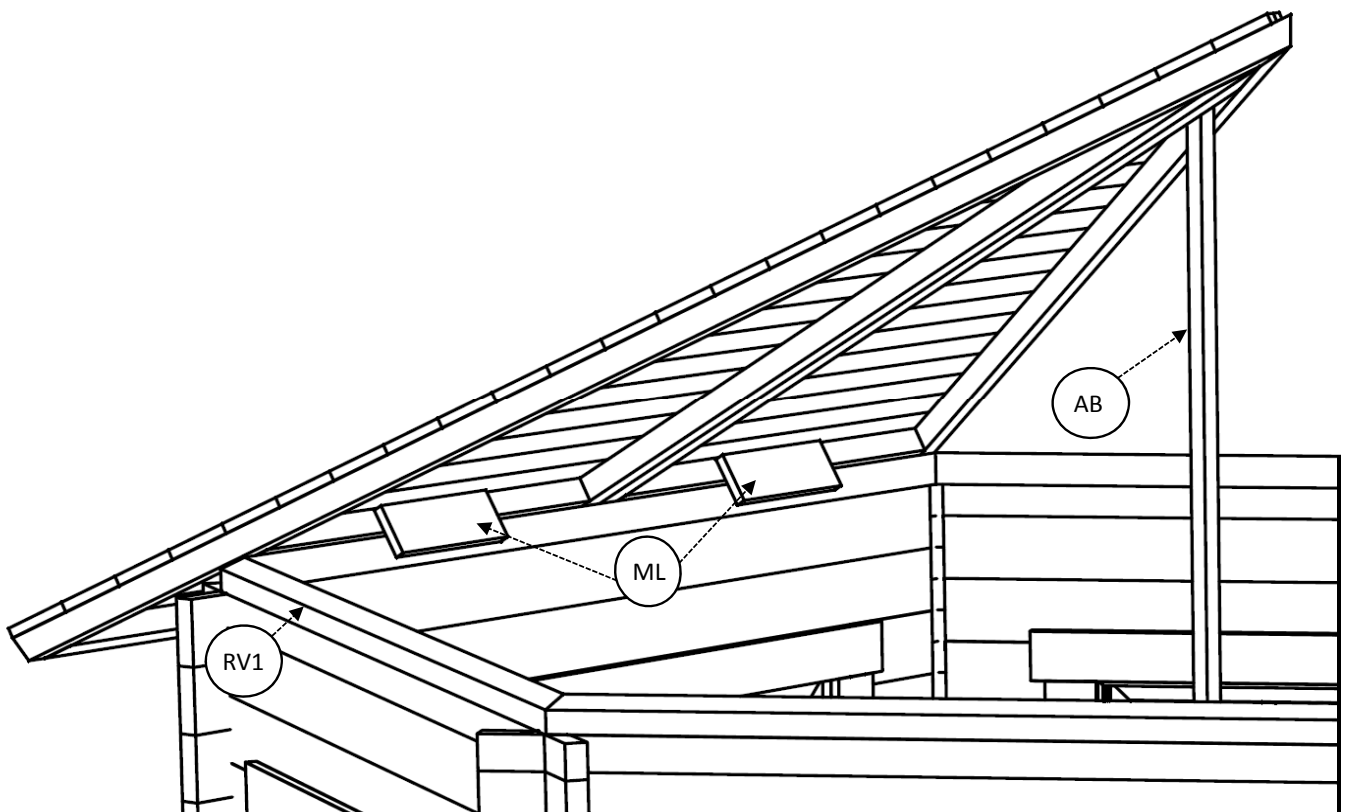

Art.Nr. 4416802

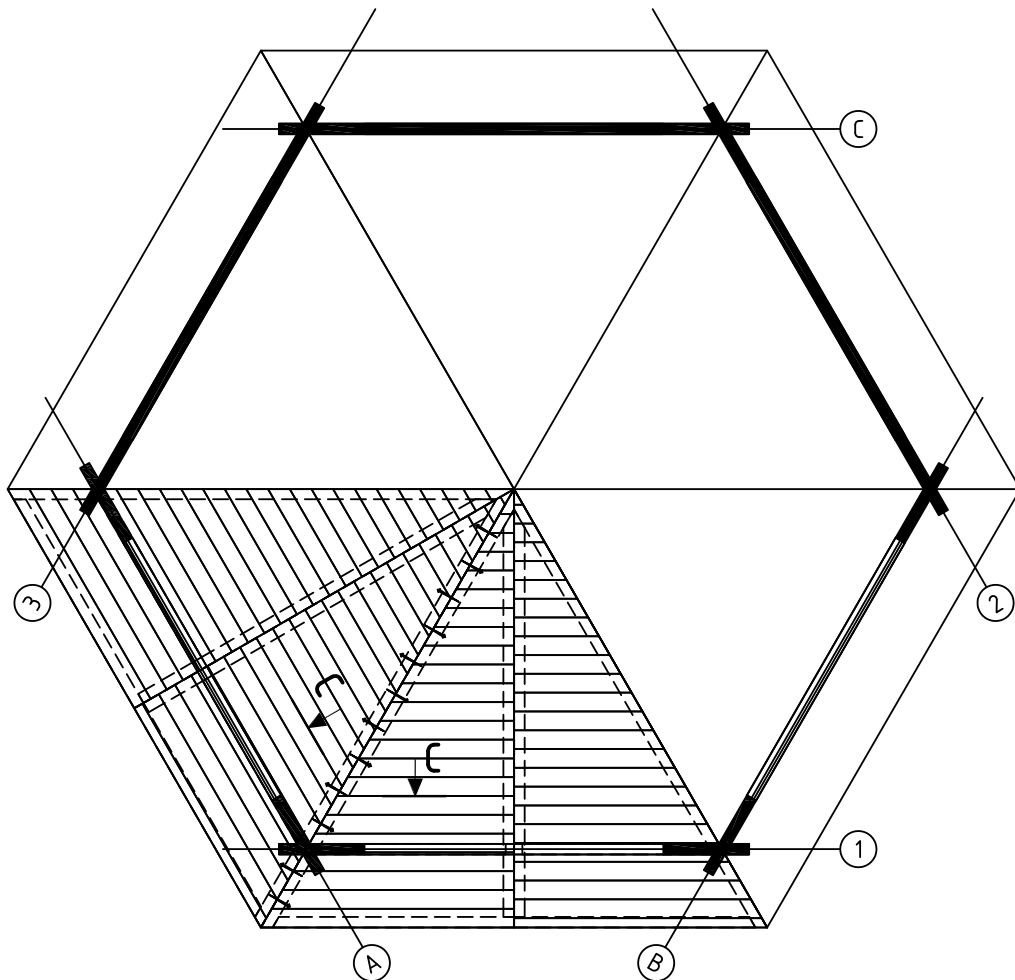

MOUNT THE FIRST ROOF SECTION YOU HAVE CREATED NEXT TO THE SECOND ONE (C-C), (WITH THE HELP OF ROOF SUPPORT AB) - MAKING SURE THEY ARE ALIGNED AND USING SCREWS HS1 (12 PCS) SCREW ALTERNATE SIDES ALL THE WAY UP, (DO NOT TIGHTEN UNTIL ALL PANELS HAVE BEEN ATTACHED, YOU MAY NEED TO ADJUST THE POSITIONING AND HEIGHT AT THE END). ONCE THE CORRECT POSITIONING HAS BEEN ACHIEVED TIGHTEN ALL SCREWS.

MONTIEREN SIE NUN NACHEINANDER DIE EINZELNEN DACHFLÄCHENDREIECKE UNTER ZUHILFENAHME DER STÜTZE AB. VERBIDNEN SIE DIE EINZELNEN DREIECKE WIEDER MIT DEN SCHRAUBEN HS1 (12 ST.) VOM BODEN BIS ZUR SPITZE. DIE SCHRAUBEN BITTE NICHT SOFORT FEST ANZIEHEN, SO DASS SIE DIE DACHELEMENTE GGF. NOCH JUSTIERT WERDEN KÖNNEN. NACHDEM ALLE DREIECKE AN SEINER KORREKTE POSITION SIND UND DAS DACH JUSTIERT WURDE, BITTE DIE SCHRAUBEN FEST ANZIEHEN.

PLACER SUR LE TOIT LES ÉLÉMENTS DE TOIT PRÉASSEMBLÉS CÔTE À CÔTE (C - C) , EN VOUS AIDANT DU POTEAU DE MAINTIEN DE TOIT AB. ASSUREZ-VOUS DE LEUR BON ALIGNEMENT ET VISSER LES ENSEMBLE À INTERVALLE RÉGULIER EN UTILISANT LES VIS HS1 (12 VIS POUR FIXER À CHAQUE FOIS 2 PANNEAUX). ATTENTION, NE PAS VISSER À FOND TANT QUE TOUS LES PANNEAUX NE SONT PAS MIS EN PLACE, CAR VOUS AUREZ PEUT-ÊTRE BESOIN D'AJUSTER LE POSITIONNEMENT DE CERTAINS D'ENTRE EUX. UNE FOIS TOUS LES PANNEAUX DE TOIT MIS EN PLACE CORRECTEMENT, ALORS VISSER À FOND.

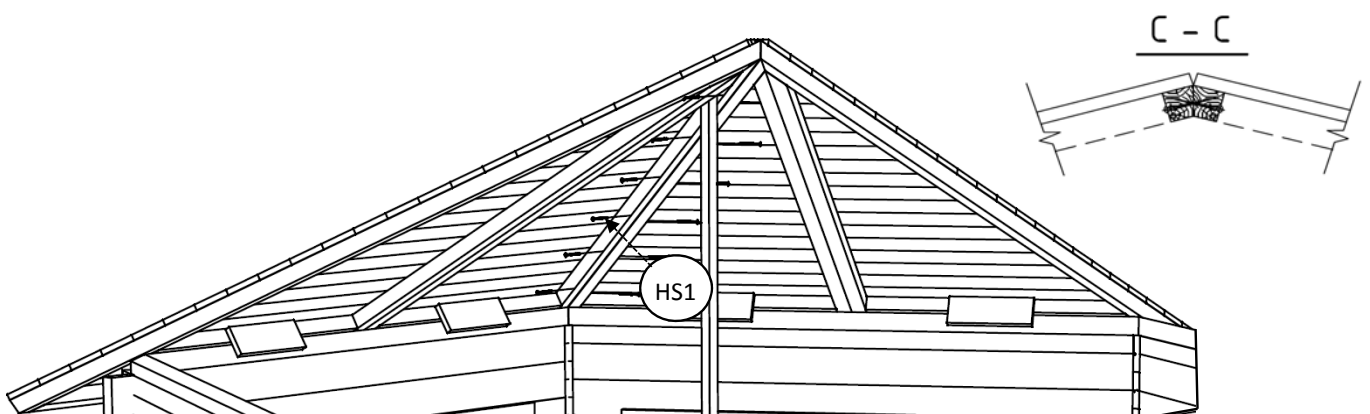

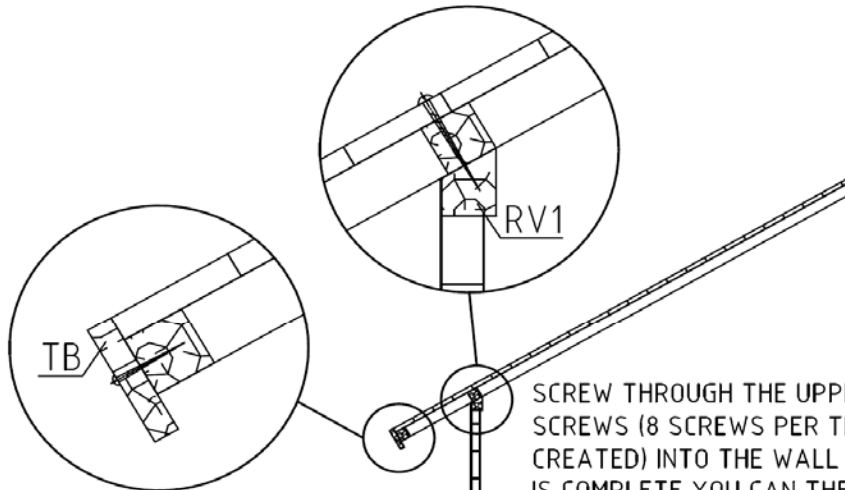

UNDER THE EAVES OF THE ROOF EDGE ATTACH THE FASCIA BOARD TB USING SCREWS PROVIDED HS5 (3 PCS).

ANSCHLIEßEND BRINGEN SIE BITTE DIE UMLAUFENDEN ABSCHLUßBRETTER (TB) MITTELS DER DREI SCHRAUBEN HS5 JEWEILS AM UNTEREN RAHMENTEIL DER DACHFLÄCHENDREIECKE AN.

FIXER LES PLANCHES DE RIVES TB AUX EXTRÉMITÉS VISIBLES DES PANNEAUX DE TOIT AVEC LES VIS HS5 (3 VIS PAR PLANCHE).

SCREW THROUGH THE UPPER PART OF THE ROOFING USING HS4 SCREWS (8 SCREWS PER THE DOUBLE PANEL SECTION YOU CREATED) INTO THE WALL SECTION UNDERNEATH (RV1). ONCE THIS IS COMPLETE YOU CAN THEN REMOVE THE TEMPORARY SUPPORTS ML AND HS3.

SCHRAUBEN SIE NUN DURCH DIE DACHELEMENTE (B/B, C/C ETC.) DIE SCHRAUBEN HS4 (8 SCHRAUBEN JE DOPPELDREIECK) IN DIE DARUNTER LIEGENDE KOMPONENTE RV1 UM DIE DACHFLÄCHEN MIT DEN WÄNDEN ZU VERBINDEN. SOBALD DIES ABGESCHLOSSEN IST, KÖNNEN DIE TEMPORÄREN STÜTZEN ML UND A/B ENTFERNT WERDEN.



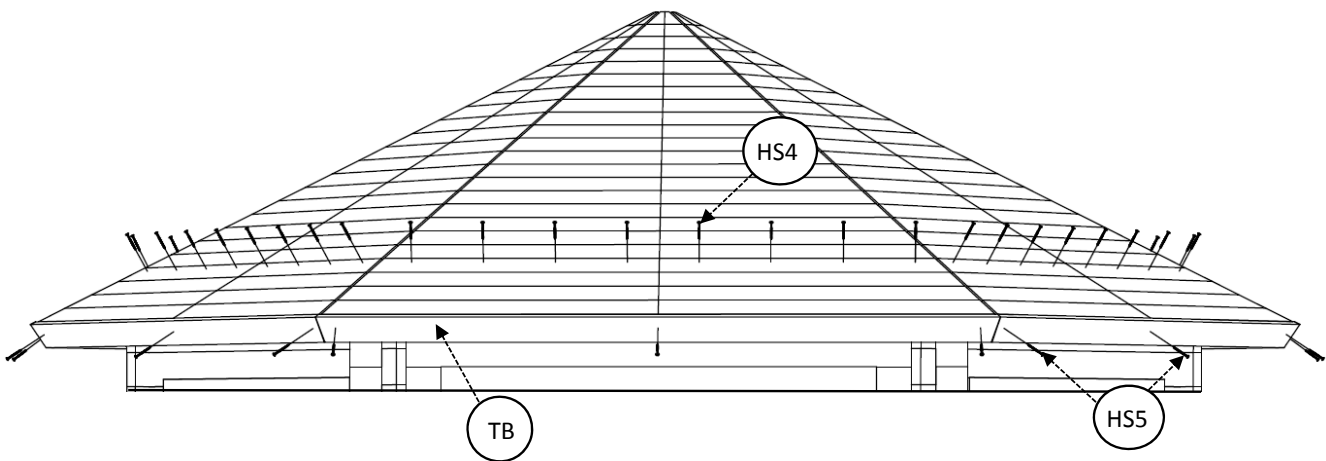









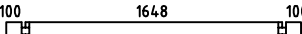
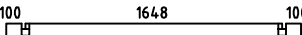
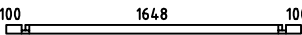

VISSER LES PANNEAUX DE TOIT EN PLACE AUX MADRIERS SUPÉRIEURS DE FINITION (RV1) EN UTILISANT LES VIS HS4 (8 VIS PAR PANNEAUX PRÉASSEMBLÉS). UNE FOIS TERMINÉE, VOUS POUVEZ ENLEVER LES SUPPORTS ML DE CHAQUE PANNEAU ET LE POTEAU DE MAINTIEN DE TOIT AB.

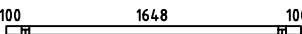
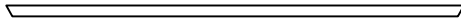
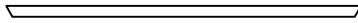
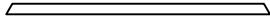

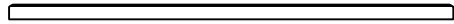
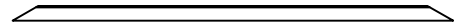
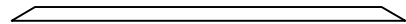

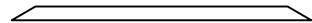
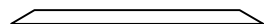

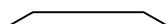



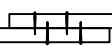

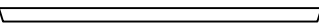

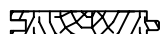
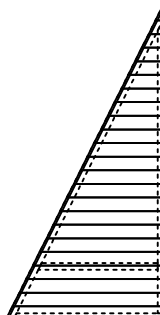
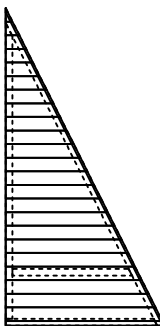
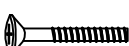



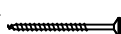

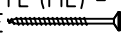
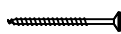
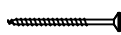
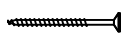
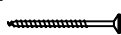

THEN YOU ARE READY TO APPLY SHINGLES OR FELT (NOT SUPPLIED).

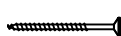
NUN KÖNNEN SIE DAMIT BEGINNEN DIE DACHEINDECKUNG ZU VERLEGEN (NICHT IM LIFERUMFANG ENTHALTEN).

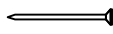
VOUS POUVEZ MAINTENANT PROCÉDER À LA MISE EN PLACE DE LA FINITION DE TOITURE (FOURNIE SÉPARÉMENT EN OPTION).

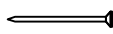
Pos	07.01.2015	Piecelist - Stücklist - Liste des composants Art.Nr. 4416802	12/15	Q.	P. (mm)	L. (mm)
001				1	44x57	350
002				1	44x57	350
003				17	44x114	350
004				17	44x114	350
005				70	44x114	1950
006				3	44x114	1950
007				2	44x57	1950
008				24	44x114	479
009				24	44x114	479
010				3	44x57	1950
IAR3	FOUNDATION - FUNDAMENT - FONDATION					
				2	70x45	3026
IAR2	FOUNDATION - FUNDAMENT - FONDATION					
				2	70x45	2345
IAR1	FOUNDATION - FUNDAMENT - FONDATION					
				6	70x45	1744
RV1	WALL FINISHING BOARD - ABSCHLUSSBOHLE - MADRIER SUPÉRIEUR DE FINITION					
				6	44x57	1750
	FLOOR BOARDS - FUSSBODENBRETTER - - LAME DE PLANCHER			17	90x18	2939
	FLOOR BOARDS - FUSSBODENBRETTER - - LAME DE PLANCHER			2	90x18	2939
	FLOOR BOARDS - FUSSBODENBRETTER - - LAME DE PLANCHER			2	90x18	2916
	FLOOR BOARDS - FUSSBODENBRETTER - - LAME DE PLANCHER			2	90x18	2605
	FLOOR BOARDS - FUSSBODENBRETTER - - LAME DE PLANCHER			2	90x18	2293
	FLOOR BOARDS - FUSSBODENBRETTER - - LAME DE PLANCHER			2	90x18	1981
	FLOOR BOARDS - FUSSBODENBRETTER - - LAME DE PLANCHER			2	90x18	1669
	FLOOR BOARDS - FUSSBODENBRETTER - - LAME DE PLANCHER			2	90x18	1358
	FLOOR BOARDS - FUSSBODENBRETTER - - LAME DE PLANCHER			2	90x18	1046
	FLOOR BOARDS - FUSSBODENBRETTER - - LAME DE PLANCHER			2	90x18	734
	FLOOR BOARDS - FUSSBODENBRETTER - - LAME DE PLANCHER			2	90x18	422

Pos	07.01.2015	Piecelist - Stücklist - Liste des composants Art.Nr. 4416802	13/15	Q.	P. (mm)	L. (mm)
		FLOOR BOARDS - FUSSBODENBRETTER - - LAME DE PLANCHER		2	90x18	110
AB		ASSEMBLY BATTEN - MONTAGELATTE - BAGUETTES DE MAINTIEN, NÉCESSAIRES À LA MISE EN PLACE DES PANNEAUX DE TOIT		2	28x34	1800
LF		FITTING SLAT - LOSE FEDER - PROFIL DE JONCTION		1	6x15	2939
		FLOOR FILLET-FUSSBODENLEISTE - CORNIERE DE FINITION DU PLANCHER		6	18x18	1720
TB		FASCIA BOARD - TRAUFBRETT - BANDEAU DE TOIT		6	18x90	2134
KFS-1		STORM PROTECTION - STURMLEISTE - - LATTE ANTI-TEMPETE		6	22x45	2150
ML		ASSEMBLY BATTEN - MONTAGELATTE - BAGUETTES DE MAINTIEN, NÉCESSAIRES À LA MISE EN PLACE DES PANNEAUX DE TOIT		12	18x90	
1		ROOF ELEMENT (LEFT) - DACHELEMENT (LINKE) - PANNEAU DE TOIT PRÉMONTÉ		6	62x1050	2100
2		ROOF ELEMENT (RIGHT) - DACHELEMENT (RECHTE) - PANNEAU DE TOIT PRÉMONTÉ		6	62x1050	2100
		BOLT FOR WINDOW HANDLE FITTINGS - BOLZEN FÜR FENSTERGRIFF BESCHLAG - VIS POUR FIXATION POIGNEE DE FENETRE		8		
		SCREW FOR ROOF CAP - SCHRAUBEN FÜR DACHKAPPE - - VIS DE FIXATION DU CHAPEAU DE TOIT		3	4.8x28	
		ROOF CAP - DACHKAPPE - CHAPEAU DE TOIT		1		
		SCREW FOR GEORGIAN BARS - SCHRAUBE FÜR SPROSSEN - VIS POUR FIXATION CROISILLONS BOIS DES MENUISERIES		60	2.5x20	
HS3		SCREW FOR WINDOW FILLET - SCHRAUBE FÜR GLASLEISTE - VIS DE FILET DE FENETRE		6	3x30	
HS3		SCREW FOR DOOR FILLET - SCHRAUBE ZUR BEFESTIGUNG TÜRLEISTE - VIS POUR FIXATION BAGUETTE D'ARRET DE PORTE		5	3x30	

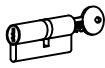
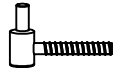
Pos	07.01.2015	Piecelist - Stücklist - Liste des composants Art.Nr. 4416802	14/15	Q.	P. (mm)	L. (mm)
HS1		SCREW FOR FIXING ROOF ELEMENTS - SCHRAUBE FÜR BEFESTIGUNG - DACHELEMENTEN - VIS DE FIXATION DES PANNEAUX DE TOIT		144	4.5x80	
HS2		SCREW FOR ASSEMBLY BATTEN (ML) - SCHRAUBEN FÜR MONTAGELATTE (ML) - VIS DE FIXATION DES BAGUETTES DE MAINTIEN POUR MISE EN PLACE DU TOIT (ML)		24	4x40	
HS32		SCREW FOR FASCIA BOARDS - SCHRAUBEN FÜR TRAUFBRETTER - VIS POUR FIXATION BANDEAU DE TOIT		18	4x40	
HS3		SCREW FOR ASSEMBLY BATTEN - SCHRAUBEN FÜR MONTAGELATTE - VIS DE FIXATION DES BAGUETTES DE MAINTIEN POUR MISE EN PLACE DU TOIT		4	4x60	
		SCREW FOR 1. WALL BEAM - SCHRAUBE FÜR 1. BOHLENREIHE - VIS DE FIXATIONS 1ÈRE RANGÉE DE MADRIERS AVEC POUTRELLES DE FONDATIONS		8	5x90	
		SCREW FOR FOUNDATION - SCHRAUBEN ZUR BEFESTIGUNG FUNDAMENT - VIS DE FIXATIONS DES POUTRELLES DE FONDATIONS		14	5x90	
HS4		SCREW FOR FIXING ROOF ELEMENTS WITH RV1 - SCHRAUBE FÜR BEFESTIGUNG DACHELEMENTEN (RV1) - VIS DE FIXATION DES PANNEAUX DE TOIT (RV1)		48	5x90	
		SCREW FOR WALL FINISHING BOARD - SCHRAUBE FÜR ABSCHLUSSBOHLE - VIS D'ASSEMBLAGE DES MADRIERS SUPÉRIEUR DE FINITION		18	5x90	
HS41		SCREW FOR DOOR JAMB - SCHRAUBE FÜR TÜRRAHMEN - VIS POUR FIXATION MONTANT DE PORTE		4	5x90	
HS59		SCREW FOR DOORSTEP - SCHRAUBEN FÜR SWELLE - VIS POUR FIXATION BARRE DE SEUIL		3	4.5x65	
FS		WINDOW HANDLE FITTINGS - FENSTERGRIFF - POIGNÉE D'OUVERTURE DE FENETRE		4		
		ZN NAIL FOR FLOOR FILLET - ZN NÄGEL FÜR FUSSBODENLEISTE - POINTE POUR CORNIERE DE FINITION DU PLANCHER		24	1.4x40	
SH44		HAMMER BLOCK - SCHLAGHOLZ - CALLE DE FRAPPE		1		
SFS		NUT FOR STORM PROTECTION - SCHRAUBENMUTTER FÜR STURMLEISTE - ECRU POUR LATTE ANTI-TEMPETE		12	D8	
		ZN NAIL FOR FLOOR - ZN NÄGEL FÜR FUSSBODENBRETTER - CLOUS POUR PLANCHER		214	2x50	
BFS		BOLT FOR STORM PROTECTION - BOLZEN FÜR STURMLEISTE - BOULON POUR LATTE ANTI-TEMPETE		12	8x80	
DFS		WASHER FOR STORM PROTECTION - DICHTSCHEIBE FÜR STURMLEISTE - RONDELLE POUR LATTE ANTI-TEMPETE		12	D8	
TL4		DOOR HANDLE FITTINGS - TÜRGRIF - POIGNEE DE PORTE		1		
TL5		SET OF DOOR LOCK COVERS - SCHLOSSBLENDEN - SET DE GARNITURES DE PORTE		1		
		CYLINDER LOCK - ZYLINDERSCHLOSS - BARILLET DE PORTE		1	30/35	
		MALE BOLT HINGE FOR DOOR - TÜRRIEGEL - PARTIE MALE DE PAUMELLE DE PORTE		6	16/52	

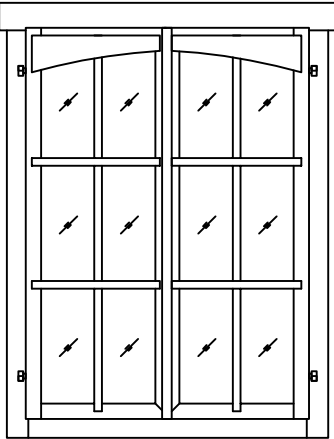
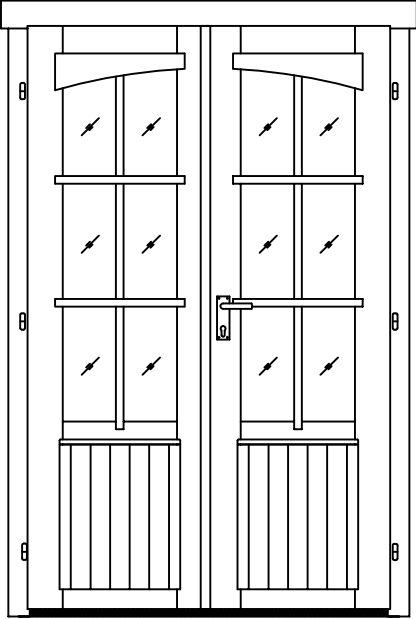
Pos	07.01.2015 Piecelist - Stücklist - Liste des composants Art.Nr. 4416802	15/15	Q.	P. (mm)	L. (mm)
	WINDOW - FENSTER - FENETRE 985x1336 DGP+A TAK.1.106.PVP.Kf 	2			
	DOOR - TÜR - PORTE 1244x1957 DGP+A TUK.2.066.PVP.MMKWb 	1			