

**Art. Nr. 347599**

**1/6**

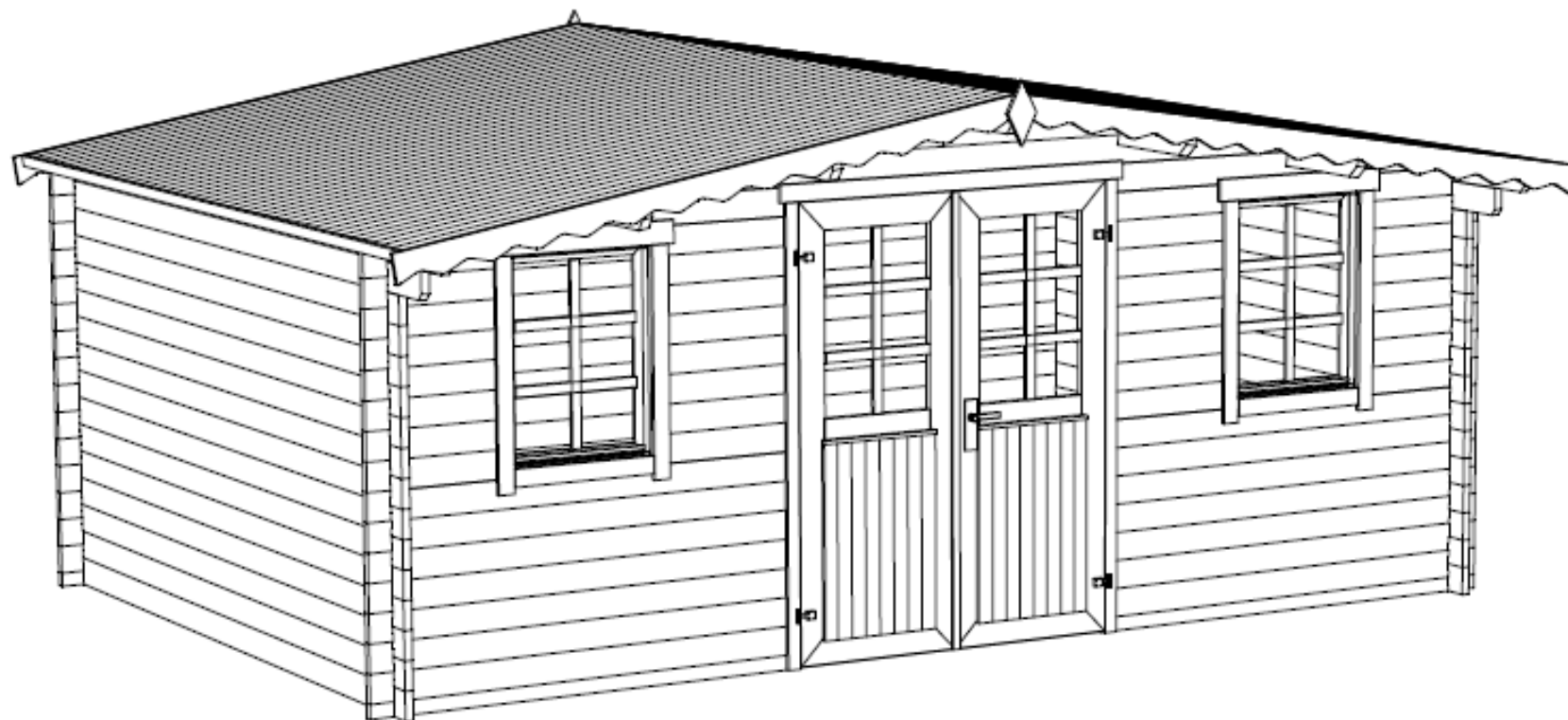

34x114  
18.10.2013

GROUNDPLAN - GRUNDPLAN - PLAN DE MASSE

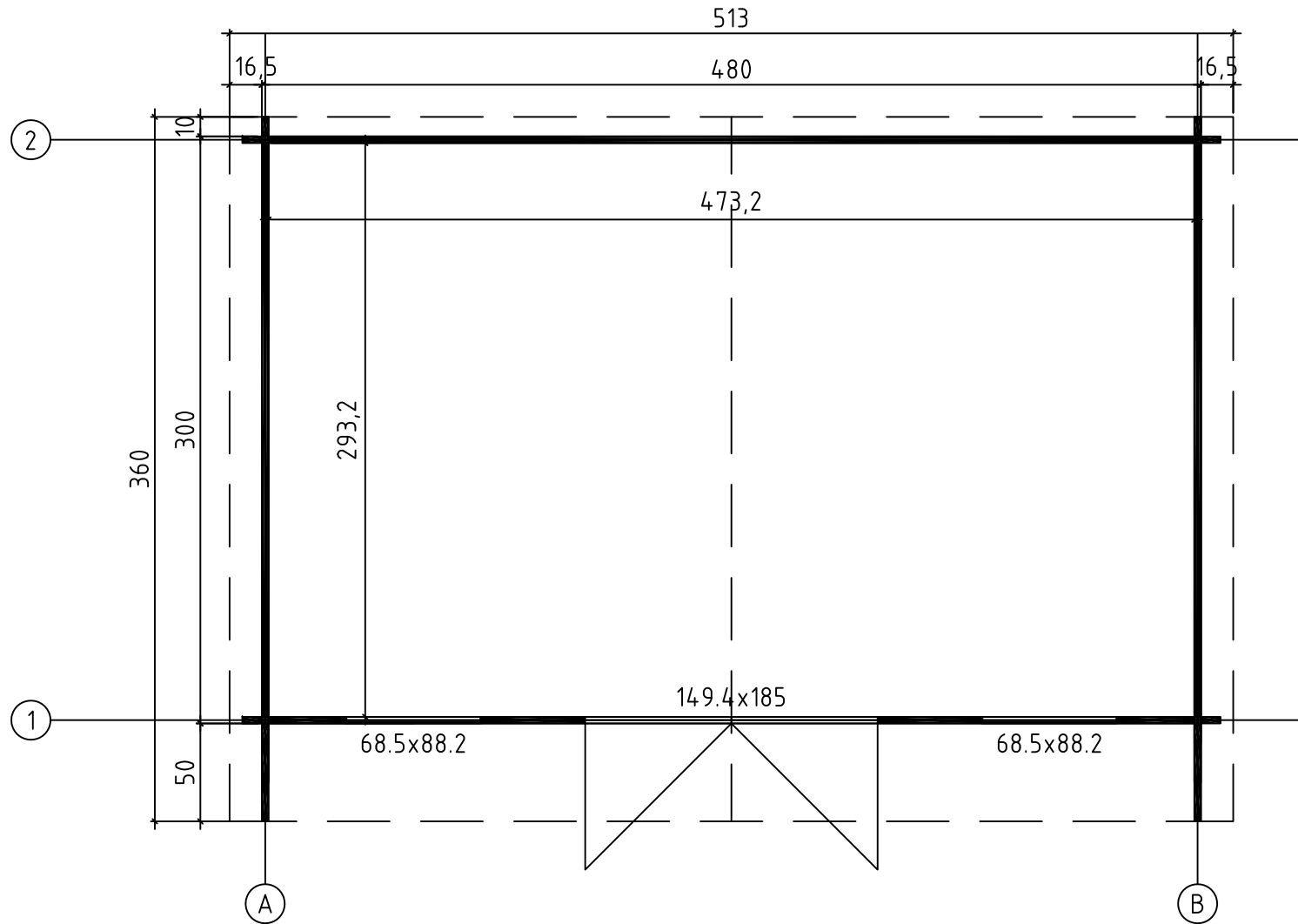

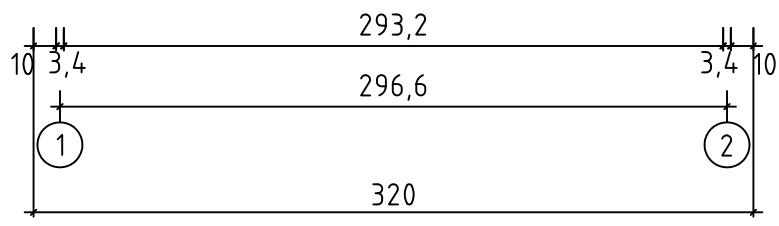
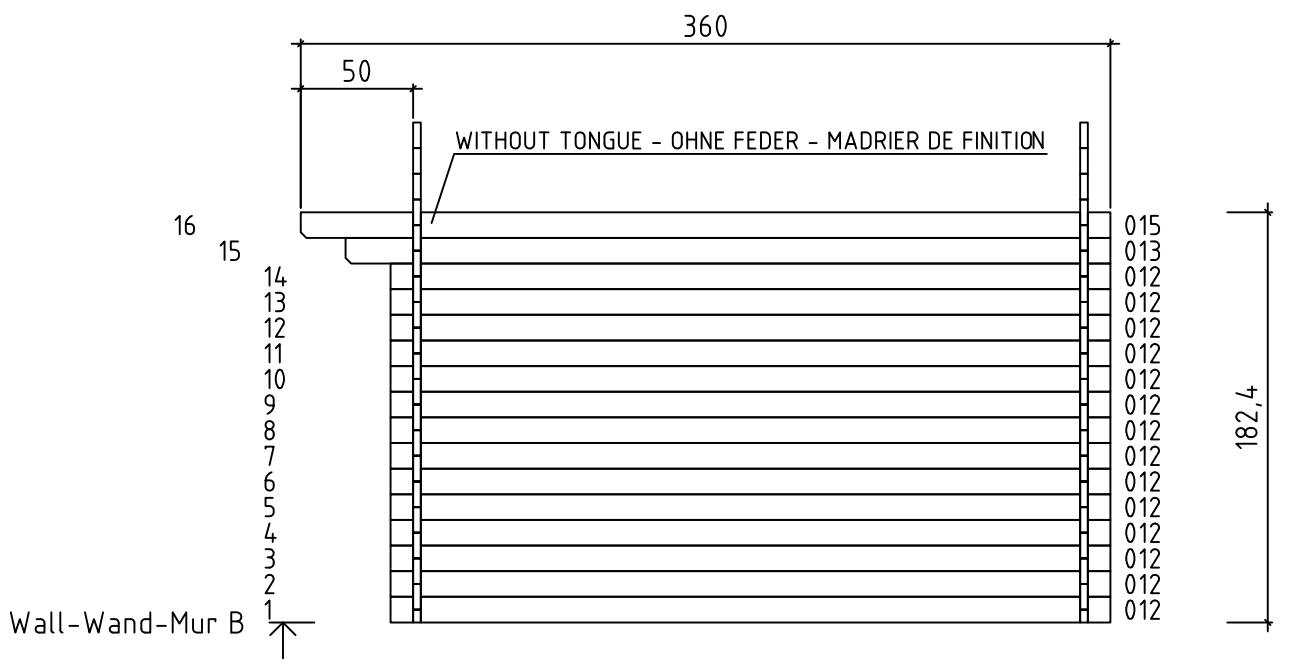
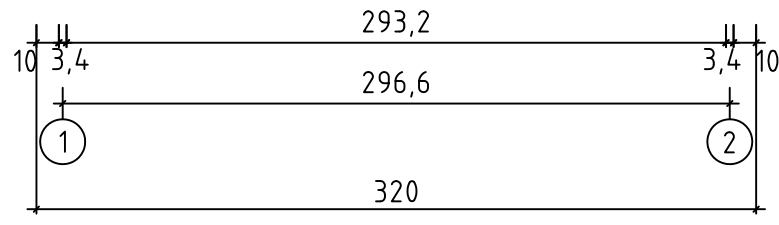
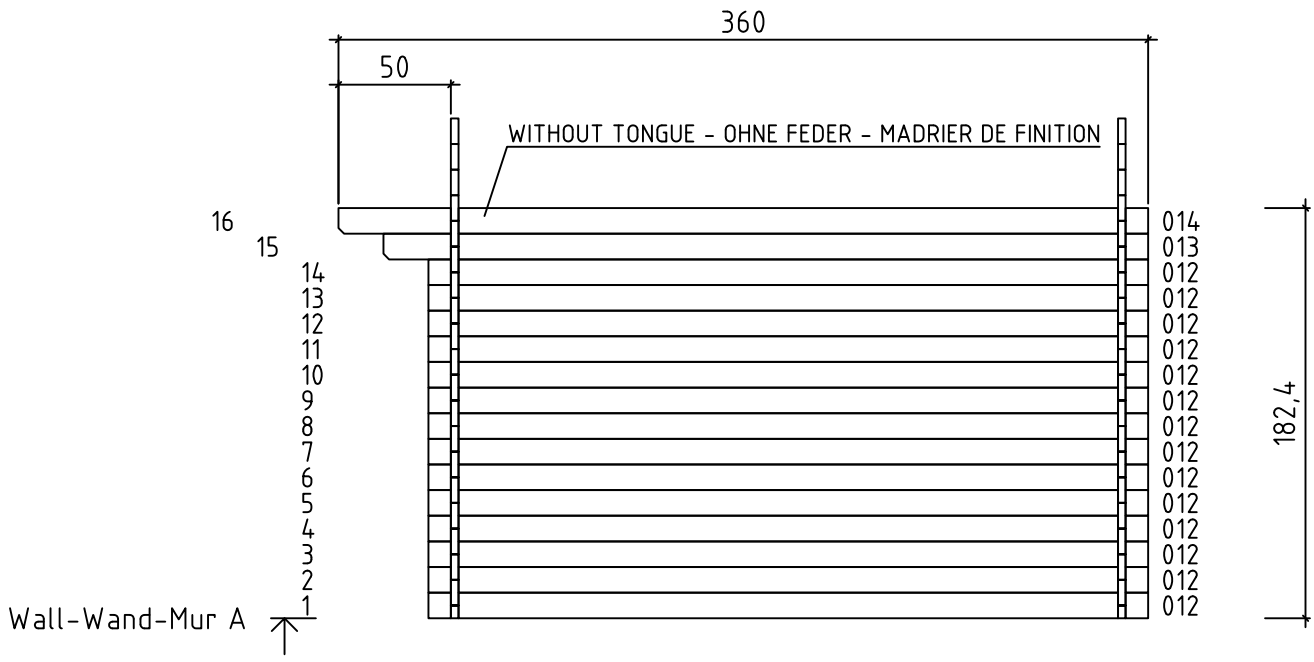







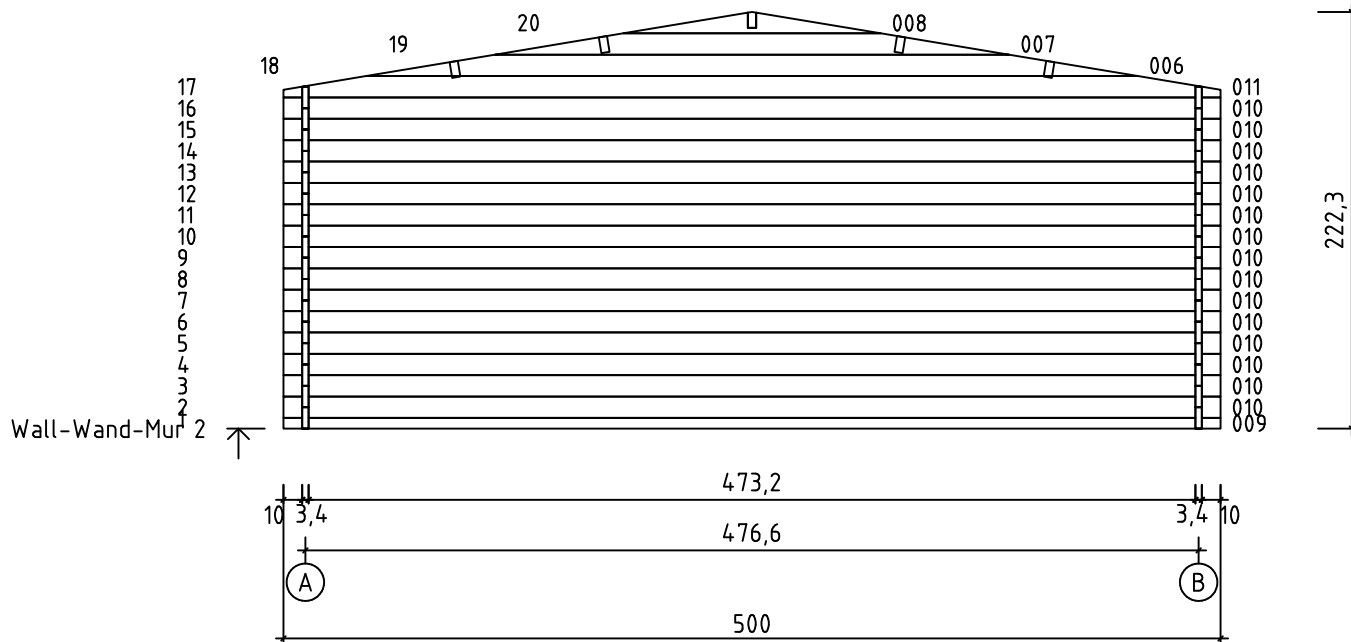
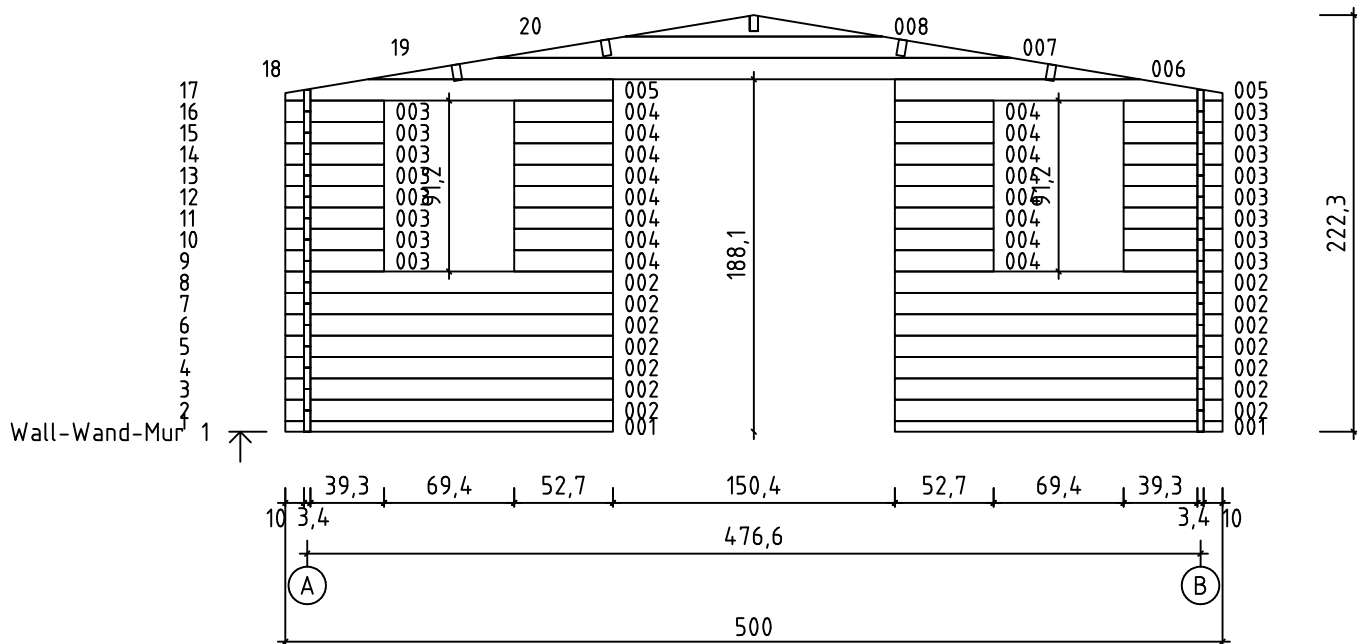



3/6

18.10.2013

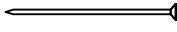
Art. Nr. 347599

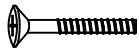

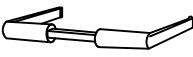
Pos	18.10.2013	Piecelist - Stücklist - Liste des composants Art. Nr. 347599	5/6	Q.	P (mm)	L (mm)
001				2	34x57	1748
002				14	34x114	1748
003				16	34x114	527
004				16	34x114	527
009				1	34x57	5000
010				15	34x114	5000
012				28	34x114	3200
013				2	34x114	3400
014				1	34x120	3600
015				1	34x120	3600
W1-1				1		
W2-1				1		
PR11		ROOF BEAM - DACHBALKEN - PANNE DE TOIT		1	44x140	3600
A.PR21		ROOF BEAM - DACHBALKEN - PANNE DE TOIT		4	44x140	3600
DB	ROOF BOARDS - DACHBRETTER - VOLIGES			80	90x15	2600
GL5	GABLE MOULDING - GIEBELLEISTE - PLANCHE DE RIVE			4	15x120	2650
TB	EAVES BOARD - TRAUFBRETT - BANDEAU DE TOIT			2	15x45	3600
FS	WINDOW HANDLE FITTINGS-FENSTERGRIFF - POIGNÉE D'OUVERTURE DE FENETRE			2		
HS22	SCREW FOR FIXING DOOR TO THE WALL - SCHRAUBE ZUR BEFESTIGUNG TÜR- VIS DE FIXATION DORMANT DE PORTE			2	3.5x50	
HS3	SCREW FOR DOOR FILLET - SCHRAUBE ZUR BEFESTIGUNG TÜRLEISTE - VIS D'ASSEMBLAGE DU CADRE DE PORTE			5	3x30	
HS59	SCREW FOR DOORSTEP - SCHRAUBEN FÜR SWELLE - VIS DE FIXATION DU SEUIL DE PORTE			3	3x30	
HS56	SCREW FOR FIXING BOLT HINGE - SCHRAUBE FÜR TÜRRIGEL - VIS DE FIXATION POUR CHARNIERES ET GONDS DE PORTE			16	4.5x25	
HS58	SCREW FOR FIXING BOLT HINGE - SCHRAUBE FÜR TÜRRIGEL - VIS DE FIXATION POUR CHARNIERES ET GONDS DE PORTE			12	4.5x35	

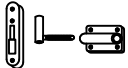
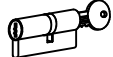
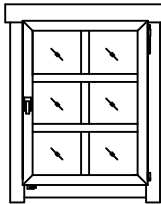
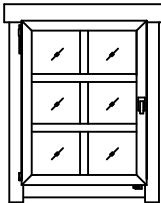
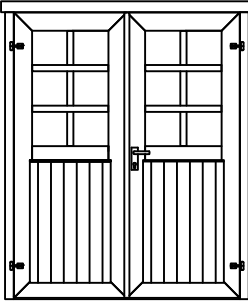
Pos	18.10.2013	Piecelist - Stücklist - Liste des composants Art. Nr. 347599	6/6	Q.	P (mm)	L (mm)
HS77	SCREW FOR DOOR JAMB - SCHRAUBE FÜR TÜRRAHMEN - VIS DE FIXATION POUR MONTANT DE PORTE			2	4x60	
HS41	SCREW FOR DOOR JAMB - SCHRAUBE FÜR TÜRRAHMEN - VIS DE FIXATION POUR MONTANT DE PORTE			2	5x90	
SH34	HAMMER BLOCK - SCHLAGHOLZ - CALLE DE FRAPPE			1	34	
NFD1	NAIL FOR WINDOW/DOOR CROSS SLOT STRAIGHT - NÄGEL FÜR FENSTER/TÜREN EISENWAREN - POINTE POUR QUINCAILLERIE POUR PORTES ET FENETRES			48	1.4x30	
PR	WINDOW/DOOR CROSS SLOT STRAIGHT (PLASTIC) - FENSTER/TÜREN EISENWAREN - QUINCAILLERIE POUR PORTES ET FENETRES			24		
TS	BOLT FOR WINDOW HANDLE FITTINGS - BOLZEN FÜR FENSTERGRIFF BESCHLAG - BOULON POUR POIGNEE D'OUVERTURE DE FENETRE			4		
TL	LATCH BOLT FÜR DOUBLE DOOR - TORRIEGEL - LOQUET POUR DOUBLE PORTE			2	90	
GS	GABLE SEGMENT-DECKBLATT - LOSANGE DE FINITION			2		
TS3	DOOR HANDLE FITTINGS-TÜRGRIF - SET DE GARNITURES DE SERRURE DE PORTE			1		
TS4	SET OF DOOR LOCK COVERS - SCHLOSSBLENDEN - SET DE GARNITURES DE SERRURE DE PORTE			1		
TT	MALE BOLT HINGE FOR DOOR - TÜRRIEGEL - PARTIE MALE DE CHARNIERE DE PORTE			4		
TS6	CYLINDER LOCK - ZYLINDERSCHLOSS - CYLINDRE DE SERRURE			1		
	WINDOW - FENSTER - FENETRE AK.1.106.SSP.Pd 685x882			1		
	WINDOW - FENSTER - FENETRE AK.1.106.SSV.Pd 685x882			1		
	DOOR - TÜR - PORTE TUK.2.056.SVP.MXPG34 14.94x1850			1		