

Staffordshire 1 70
Art.No. 7012402

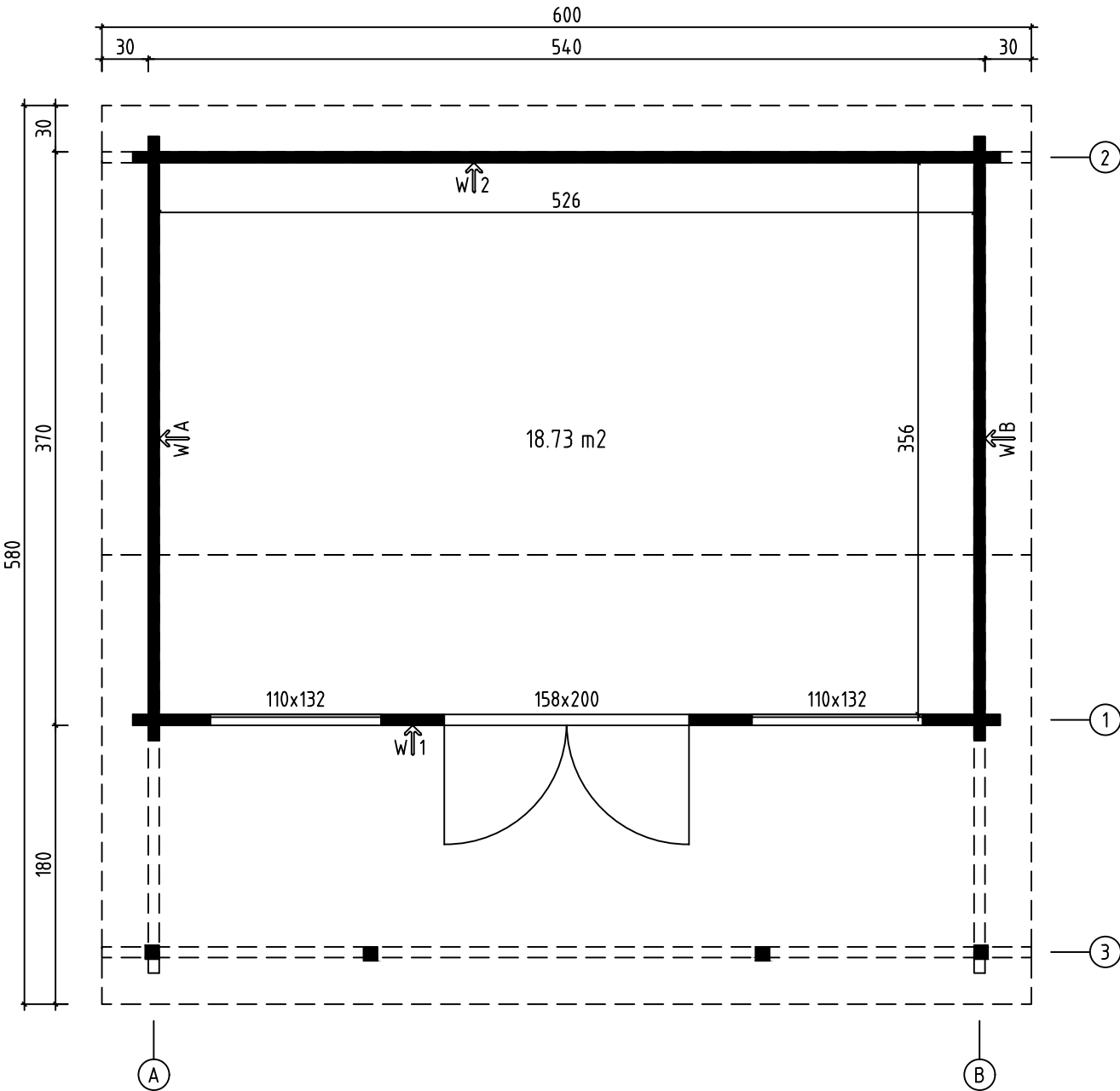

Staffordshire 170, Art.No.7012402
GROUNDPLAN - GRUNDPLAN - PLAN DE MASSE



Staffordshire 170, Art.No.7012402
FOUNDATION - FUNDAMENT - FONDATION

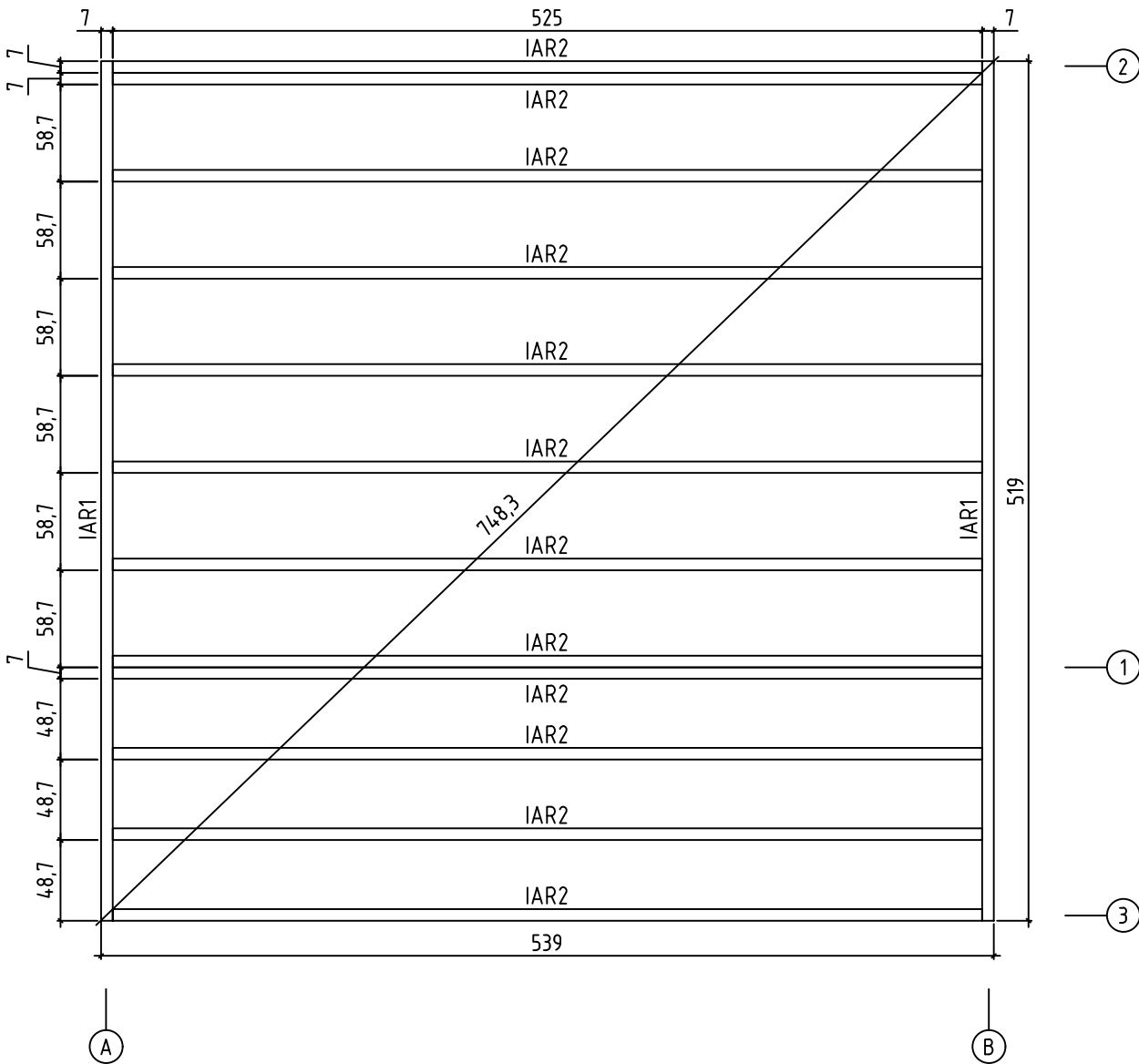

Staffordshire 170, Art.No.7012402
FLOOR BOARDS - FUSSBODENBRETTER - PLAN POSE PLANCHER
TERRACE BOARDS - TERRASSENBRETTER - PLANCHER DE TERRASSE

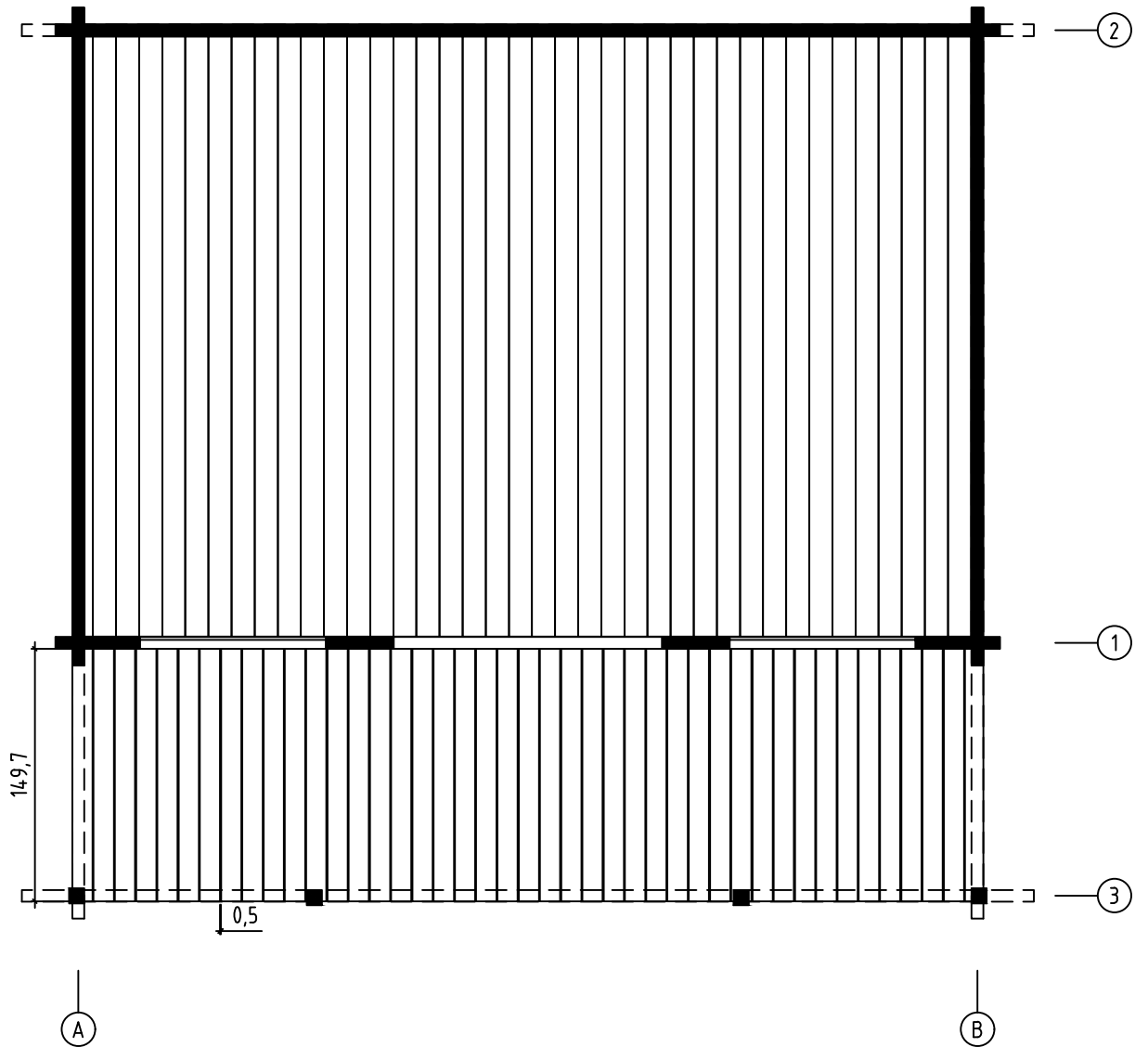

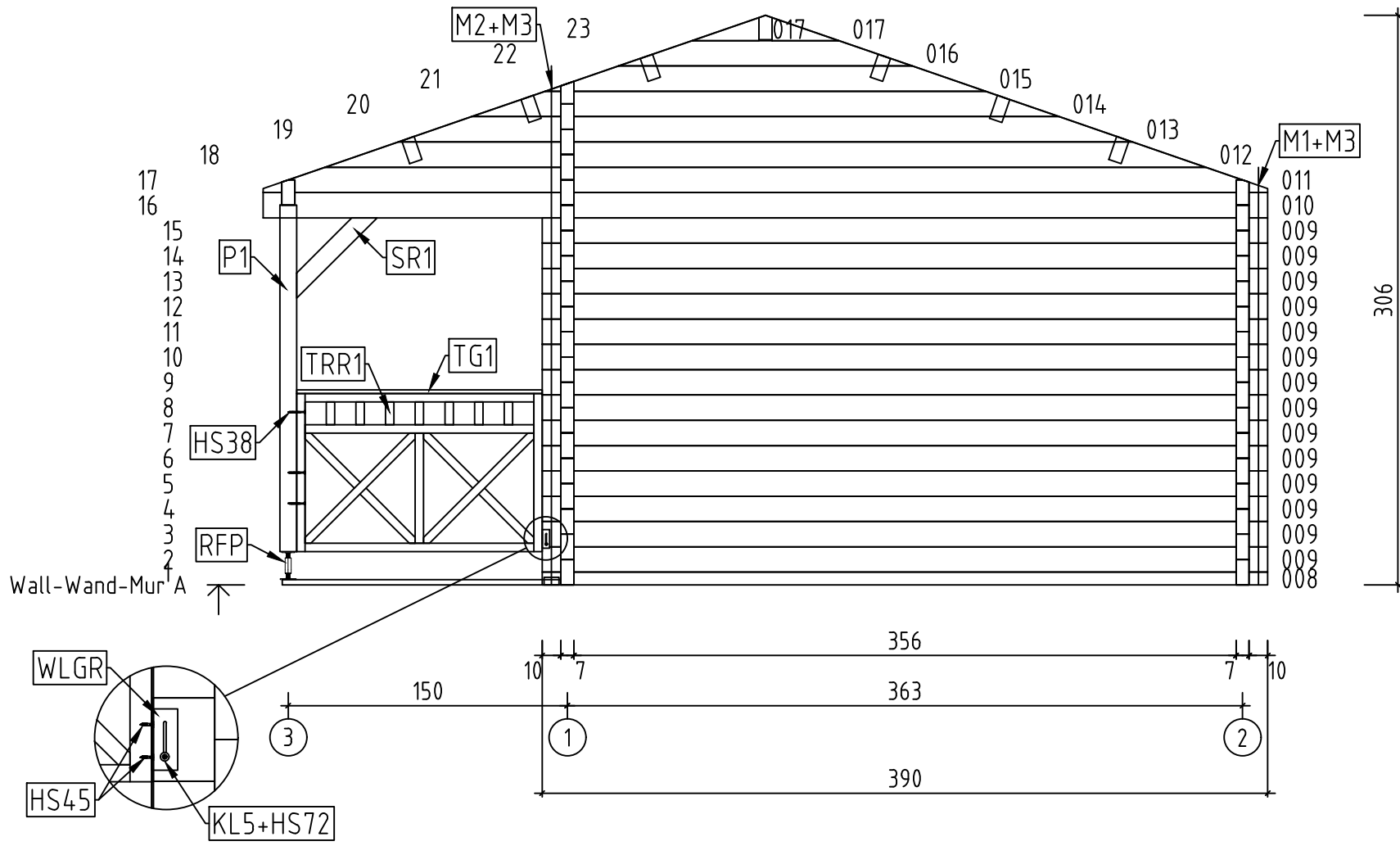

Staffordshire 170, Art.No.7012402

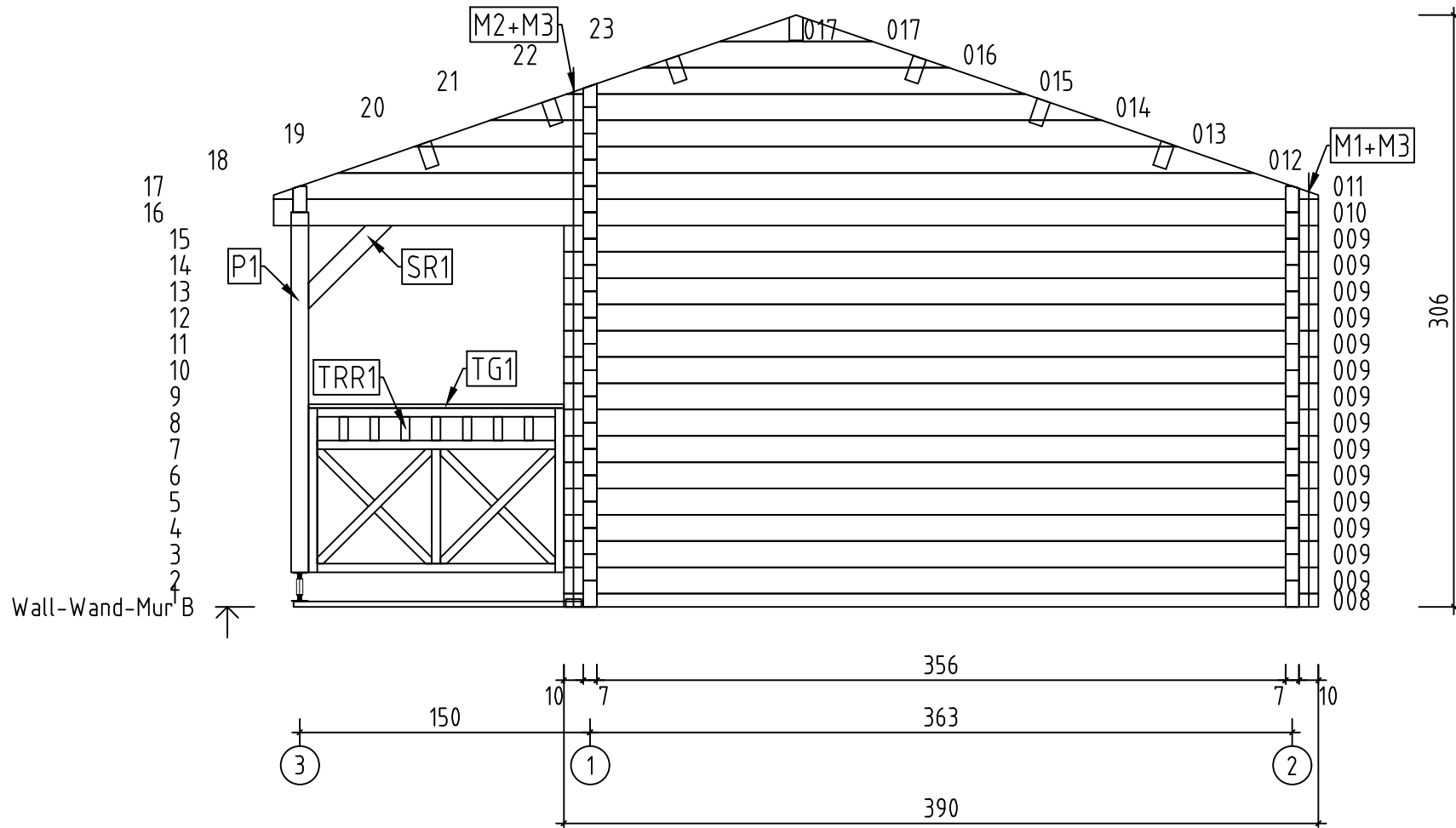





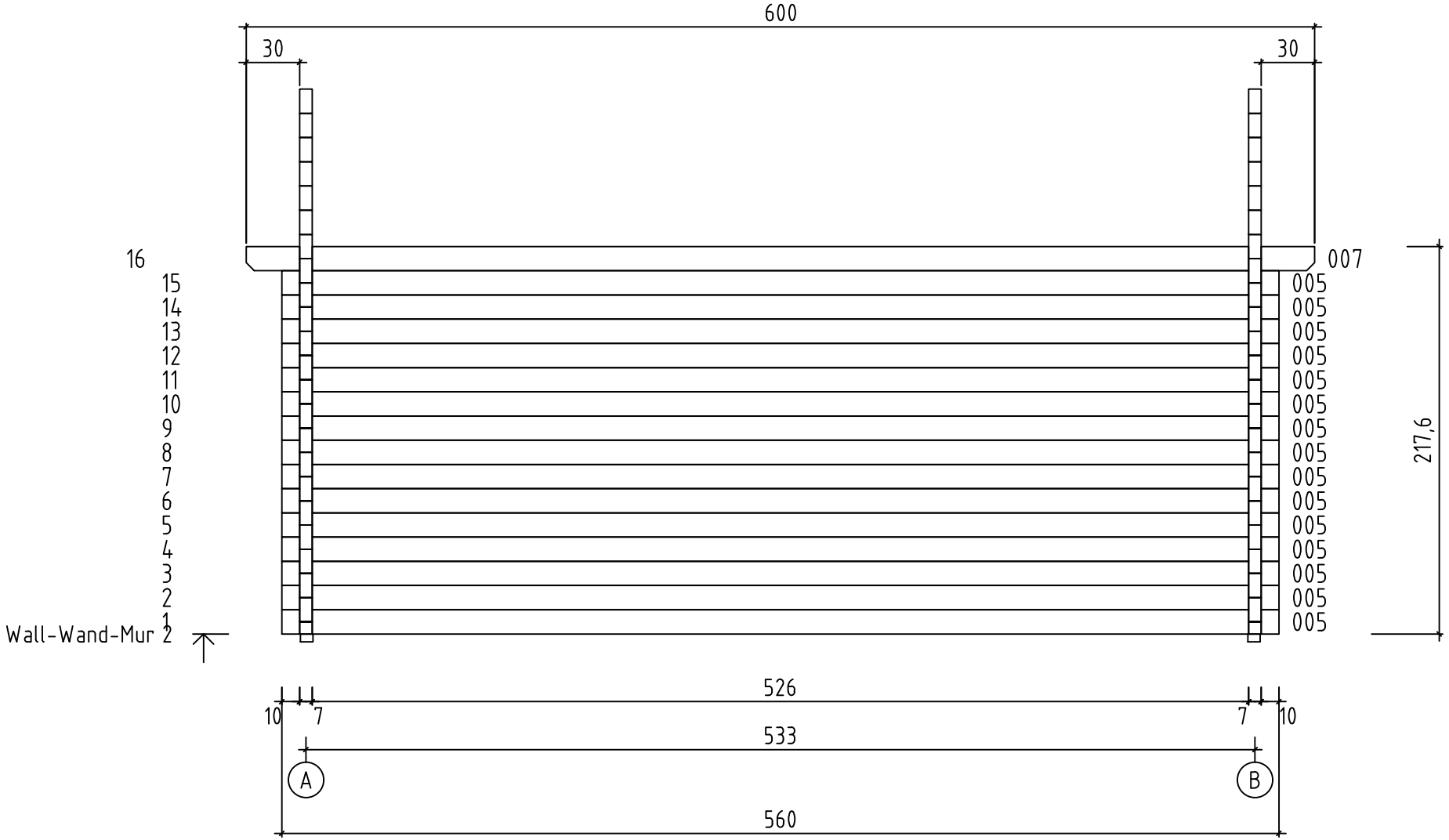



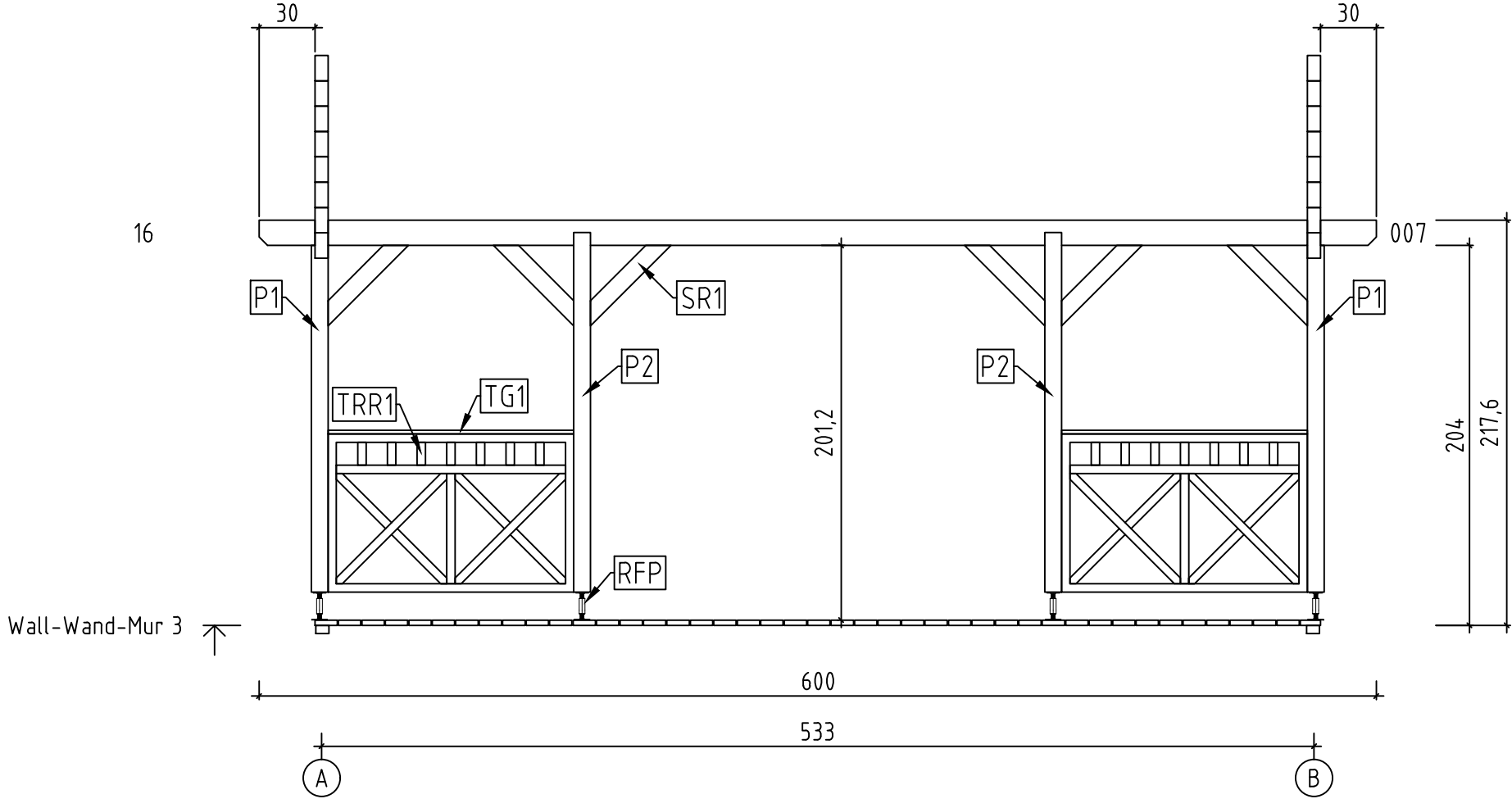

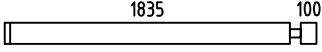

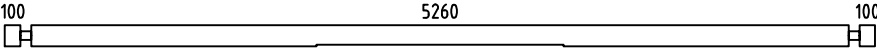
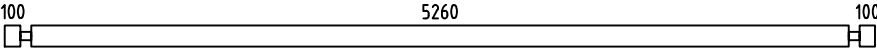
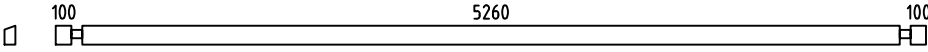
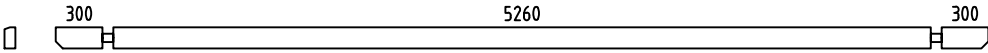
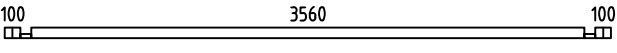
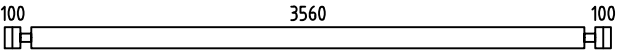
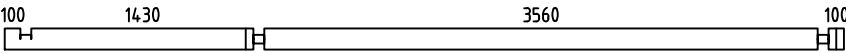

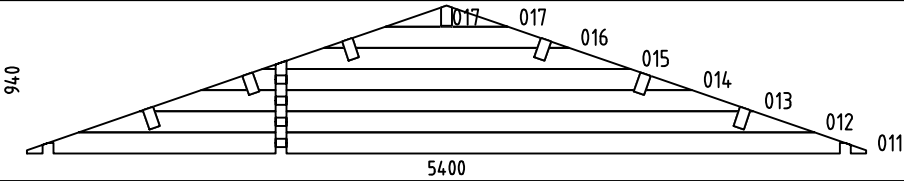
Wall-Wand-Mur B

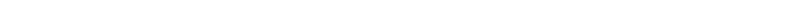

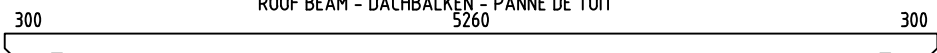
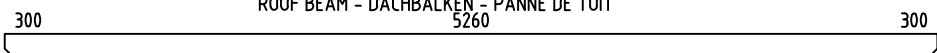









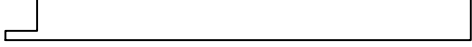
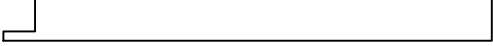



Staffordshire 170, Art.No.7012402

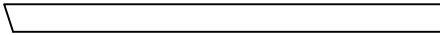



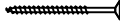
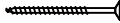



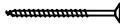
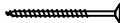
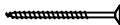

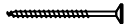
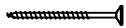
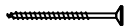
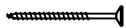
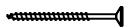
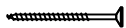
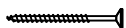
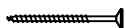
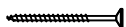
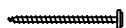
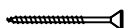
Staffordshire 170, Art.No.7012402

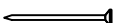

Pos	Staffordshire 170, Art.No.7012402 Piece list - Stückliste - Liste des pieces	Q.	P (mm)	L (mm)
001		10	70x136	2005
002		20	70x136	497
003		20	70x136	398
004		1	70x136	5600
005		18	70x136	5600
006		1	70x121	5600
007		2	70x136	6000
008		2	70x68	3900
009		28	70x136	3900
010		2	70x136	5400
018		1	70x10	1590
WA-1 WB-1		1 1		
IAR2	FOUNDATION - FUNDAMENT - FONDATION 	12	70x45	5250
IAR1	FOUNDATION - FUNDAMENT - FONDATION 	2	70x45	5190
SR1	RAFTER - DACHSPARREN - CHEVRON 	8	45x96	611
PR1	ROOF BEAM - DACHBALKEN - PANNE DE TOIT 	1	70x140	6000
A-PR1	ROOF BEAM - DACHBALKEN - PANNE DE TOIT 	6	70x140	6000
HLL-1	FLOOR BOARDS - FUSSBODENBRETTER - LAME DE PLANCHER 		137x28	152 m.
RB-1	ROOF BOARDS - DACHBRETTER - VOLIGES 	134	90x18	3067
SV2-1	TERRACE BOARDS - TERRASSENBRETTER - PLANCHER DE TERRASSE 	44	120x28	1497
FL-1	FLOOR FILLET-FUSSBODENLEISTE - CORNIERE DE FINITION DU PLANCHER 		15x40	18 m.
DPL-1	ROOFING FELT FILLET - DACHPAPPENLEISTE - BAGUETTE DE FIXATION DU FEUTRE BITUMEUX 	4	18x58	3117

Pos	Staffordshire 170, Art.No.7012402 Piece list - Stückliste - Liste des pieces	Q.	P (mm)	L (mm)
M1	TREADED ROD M12 - GEWINDESTANGE M12 - TIGE FILETÉE M12 	2		180
M2	TREADED ROD M12 - GEWINDESTANGE M12 - TIGE FILETÉE M12 	2		655
M3	TREADED ROD M12 - GEWINDESTANGE M12 - TIGE FILETÉE M12 	4		2000
P1	POST - PFOSTEN - POTEAU 	2	90x90	1860
P2	POST - PFOSTEN - POTEAU 	2	90x90	1930
TB-1	EAVES BOARD - TRAUFBRETT - BANDEAU DE TOIT 	2	18x90	6000
DRV-1	ROOF EDGE REINFORCEMENT - DACHRANDVERSTÄRKUNG - CORNIERE DE RENFORT DE BORD DE TOIT 	4	28x34	3000
TBE6-1	FIXING FILLET FOR WINDOW - FIXIRUNGSLEISTE FÜR FENSTER - PROFIL DE FIXATION DES FENETRES 	4	28x34	1320
TBE6-1	FIXING FILLET FOR DOOR - FIXIRUNGSLEISTE FÜR TÜR - PROFIL DE FIXATION DES PORTES 	2	28x34	2000
TG1	GUARD-RAIL FOR TERRACE - TERRASSELÄNDER - MAIN COURANTE DE TERRASSE 	4	18x90	1320
GL-1	GABLE MOULDING - GIEBELLEISTE - PLANCHE DE RIVE 	4	18x120	3117
KL4	LENGTHENING BOLT FOR TREADED ROD - VERLÄNGERUNGSMUTTER FÜR GEWINDESTANGE - MANCHON DE RACCORDEMENT DE TIGE FILETÉE 	4		
KL1	DRIVE NUT TREADED ROD - EINSHLAGMUTTER FÜR GEWINDESTANGE - ÉCROU A FRAPPER POUR TIGE FILETÉE 	4		
KL2	NUT FOR TREADED ROD - MUTTER FÜR GEWINDESTANGE - ÉCROU POUR TIGE FILETÉE 	4		
KL3	PLAIN WASHER TREADED ROD - UNTERLEGSCHIEBE FÜR GEWINDESTANGE - RONDELLE PLATE POUR TIGE FILETÉE 	4		
HS12	SCREW FOR GABLE SEGMENT - SCHRAUBEN FÜR DECKBLATT - VIS POUR FIXATION LOSANGE DE FINITION 	4	3.5x35	
HS25	SCREW FOR FLOOR BOARDS - SCHRAUBEN FÜR FUSSBODENBRETT - VIS D'ASSEMBLAGE DES LAMES DE PLANCHER 	280	3.5x50	
HS84	SCREW FOR FIXING FILLET - SCHRAUBEN FÜR FIXIRUNGSLEISTE - VIS POUR PROFIL DE FIXATION 	36	3.5x50	
HS16	SCREW FOR GABLE MOULDING - SCHRAUBEN FÜR GIEBELLEISTE - VIS DE FIXATION POUR PLANCHE DE RIVE 	40	3.5x50	
HS38	SCREW FOR FIXING TERRACE RAILING - SCHRAUBE FÜR TERRASSE VIS DE FIXATION DE GARDE-CORPS DE TERRASSE 	20	4.5x80	
NFD	SCREW FOR ROOFING FELT FILLET - SCHRAUBEN FÜR DACHPAPPENLEISTE - VIS POUR BAGUETTE FIXATION FEUTRE BITUMEUX 	28	4x40	
HS32	SCREW FOR EAVES BOARDS - SCHRAUBEN FÜR TRAUFBRETT - VIS DE FIXATION POUR BANDEAU DE TOIT 	26	4x40	
HS26	SCREW FOR ROOF EDGE REINFORCEMENT - SCHRAUBEN FÜR DACHRANDVERSTÄRKUNG - VIS POUR RENFORT DE BORD DE TOIT 	26	4x40	

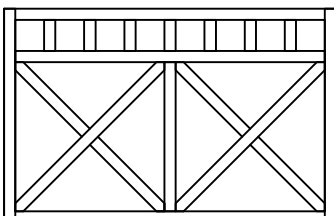
Pos	Staffordshire 170, Art.No.7012402 Piece list - Stückliste - Liste des pieces	Q.	P (mm)	L (mm)	
HS45	SCREW FOR SLIDING WALL TIE - SCHRAUBEN FÜR WAND SCHIEBEREGLER SCHIEBEREGLER - VIS POUR FIXATION ÉQUERRE MÉTALLIQUE AU PARAVENT		8	4x40	
HS34	SCREW FOR POST - SCHRAUBEN FÜR PFOSTEN - VIS DE FIXATION DES POTEAUX		8	4x60	
HS30	SCREW FOR TERRACE REAR BOARDS - SCHRAUBEN FÜR TERRASSENRAND - VIS DE FIXATION POUR MAIN COURANTE DE TERRASSE		16	4x60	
HS40	SCREW FOR 1. WALL BEAM - SCHRAUBE FÜR 1. BOHLENREIHE - VIS DE FIXATION DES FONDATIONS		8	5x120	
HS39	SCREW FOR FUNDAMENT - SCHRAUBEN ZUR BEFESTIGUNG FUNDAMENT - VIS POUR FONDATION		52	5x120	
HS42	SCREW FOR GABLE - SCHRAUBEN FÜR GIEBEL - VIS POUR FIXATION DES PIGNONS		28	5x120	
HS43	SCREW FOR ROOF BEAMS - SCHRAUBEN FÜR DACHBALKEN - VIS POUR PANNE DE TOIT		14	5x120	
HS44	SCREW FOR RAFTER - SCHRAUBEN ZUR BEFESTIGUNG DACHSPARREN - VIS POUR CHEVRON		16	6x180	
HS49	SCREW FOR POST HEIGHT ADJUSTMENT - SCHRAUBEN FÜR REGULIERUNGSSCHRAUBE FÜR PFOSTEN - VIS DE FIXATION DE SUPPORT RÉGLABLE DE POTEAU		32	6x50	
MS	SCREW FOR DOORSTEP - SCHRAUBEN FÜR TÜRSCHWELLE - VIS DE FIXATION DU SEUIL DE PORTE		3	4.5x65	
NF3	SCREW FOR TERRACE BOARD - SCHRAUBEN FÜR TERRASSENBRETT - VIS POUR LAME DE SEUIL D'ENTREE DE TERRASSE		352	4.2x55	
HS72	SCREW FOR SLIDING WALL TIE - SCHRAUBEN FÜR WAND SCHIEBEREGLER - VIS POUR FIXATION ÉQUERRE MÉTALLIQUE AU PARAVENT		2	5x60	
SH70	HAMMER BLOCK - SCHLAGHOLZ - CALLE DE FRAPPE		2		
NFF	ZN NAIL FOR FLOOR FILLETS - ZN NÄGEL FÜR FUSSBODENLEISTEN - POINTE POUR PANNEAUX DE PLANCHER		35	1.4x40	
NF2	ZN NAIL FOR ROOF - ZN NÄGEL FÜR DACHBRETTER - POINTE POUR TOIT		740	2.1x50	
ORZ	MONTAGE SET FOR DOORS AND WINDOWS - MONTAGE-SET FÜR TÜREN UND FENSTER - JEU DE MONTAGE PORTES ET FENETRES		1		
GS	GABLE SEGMENT-DECKBLATT - LOSANGE DE FINITION		2		
KL5	PLAIN WASHER FOR SLIDING WALL TIE - UNTERLEGSSCHEIBE FÜR WAND SCHIEBEREGLER - RONDELLE POUR SABOT MÉTALLIQUE		2		
WLGR	SLIDING WALL TIE - SCHIEBEREGLER FÜR WAND - EQUERRE MÉTALLIQUE DE FIXATION DU PARAVENT		2		
RFP	POST HEIGHT ADJUSTMENT - REGULIERUNGSSCHRAUBE FÜR PFOSTEN - SUPPORT RÉGLABLE DE POTEAU		4		
TRR1	TERRACE RAILING - TERRASSE - GARDE-CORPS DE TERRASSE		4	850	1320

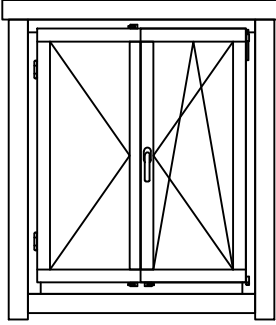
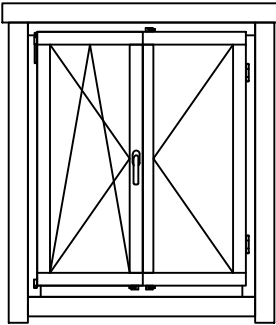
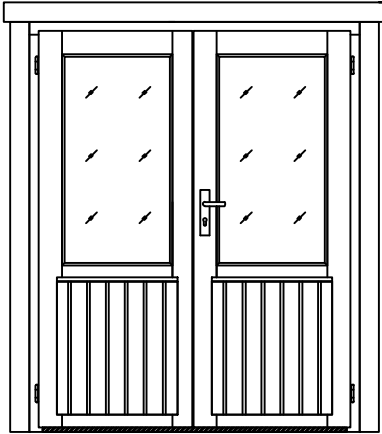
Pos	Staffordshire 170, Art.No.7012402 Piece list - Stückliste - Liste des pieces	Q.	P (mm)	L (mm)
	WINDOW-FENSTER-FENETRE <div style="text-align: right;">1100x1320 2+ TA.0P.dK</div> 	1		
	WINDOW-FENSTER-FENETRE <div style="text-align: right;">1100x1320 2+ TA.0V.dK</div> 	1		
	DOOR-TÜR-PORTE <div style="text-align: right;">1580x2000 2+ TU.30P.bK</div> 	1		

