

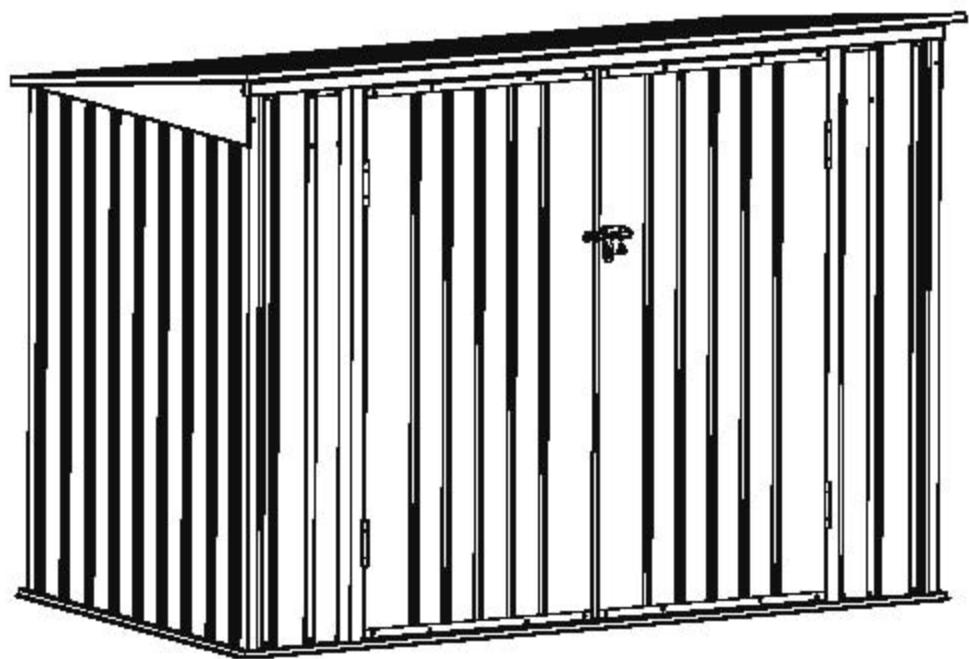























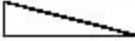





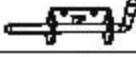







Outdoor dustbin







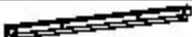
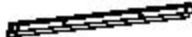

Teilliste / Part list

Nr. / No.		Anzahl / Quantity
1		2
3		1
4		1
P2		2
DF		1
DG		1
10		1
12		1
P3		6
P4		1
P4A		1
P4B		1
29R		1
29L		1
21L		1
21R		1
9		1
11L		1
11R		1



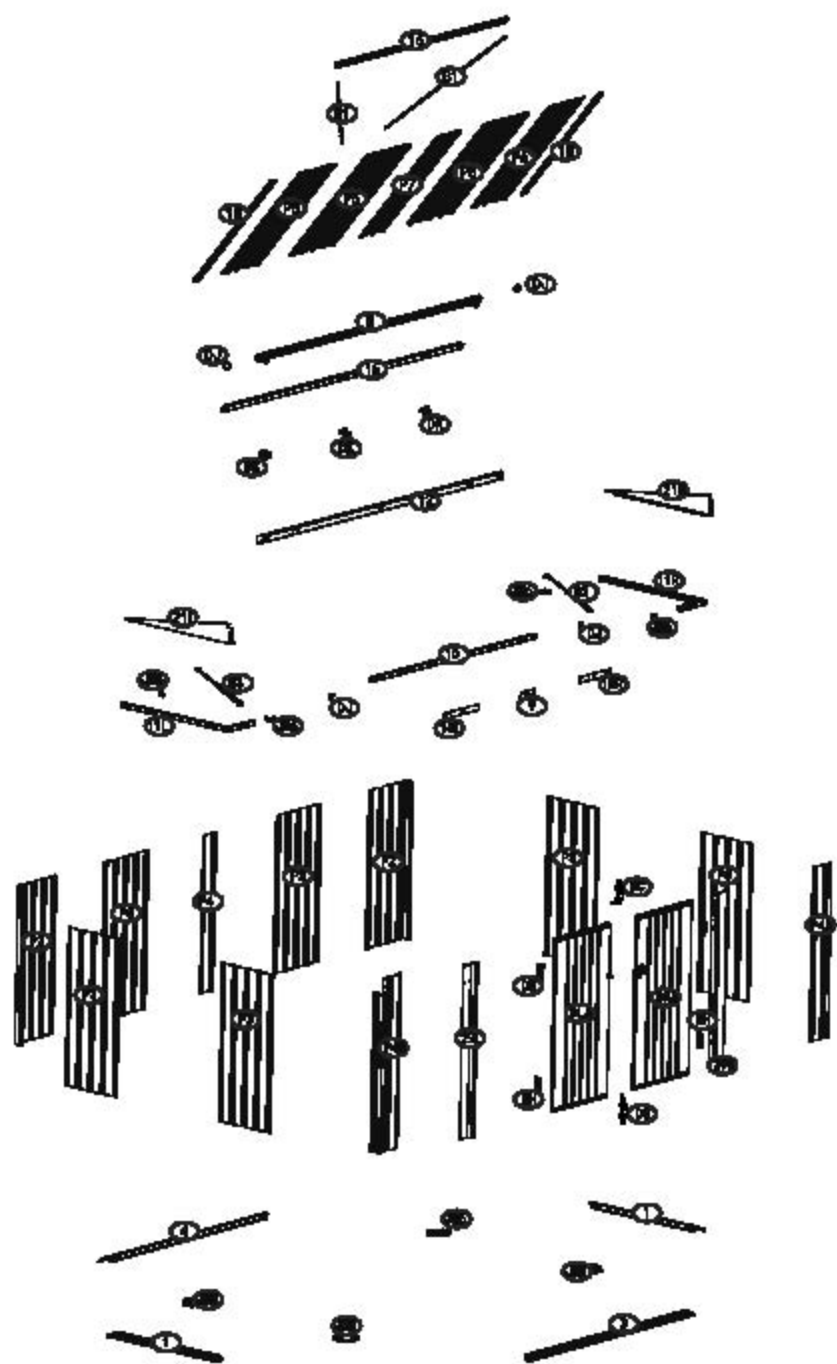

Nr. / No.		Anzahl / Quantity
JM6		4
DRA		1
DLA		1
DC		2
DH		4
JM5		4
15L		1
15R		1
GS		2
DK		3
DJ		4
15		1
8		1
18		2
16		1
P5		2
P6		1
P7		1
P8		1
B1		2

Teilleiste / Part list

Nr. / No.		Anzahl / Quantity
20U		2
20D		2
DX2		4
F1		225
F2		10
F3		32
V2		175
M8		2



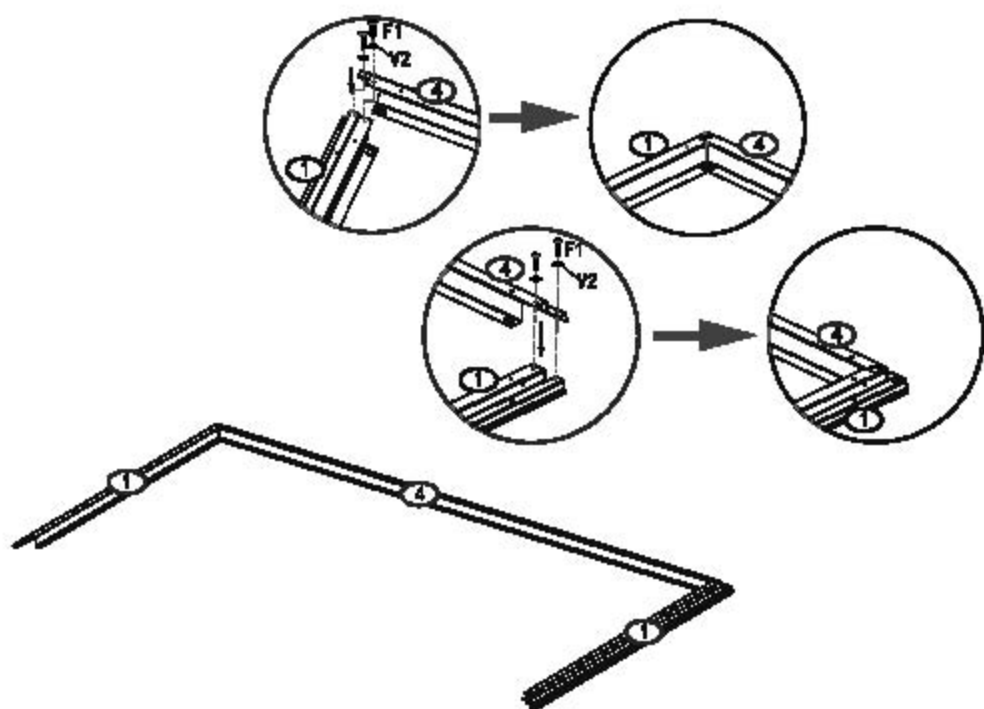

1.

Telle / Parts	Nr. / No.	Stk. / Qty.
	1	2
	4	1
	F1	4
	V2	4



2.

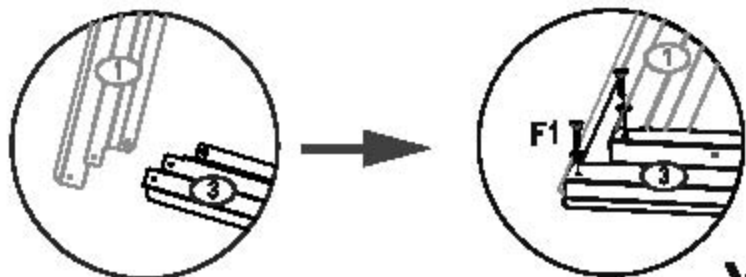

Teile / Parts	Nr. / No.	Stk. / Qty.
	3	1
	F1	4
	Y2	4

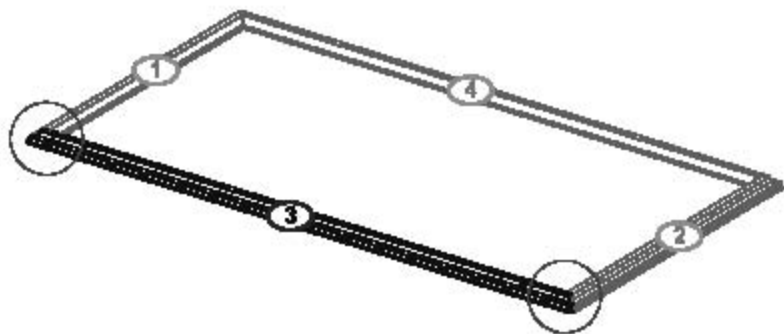

X2



3.

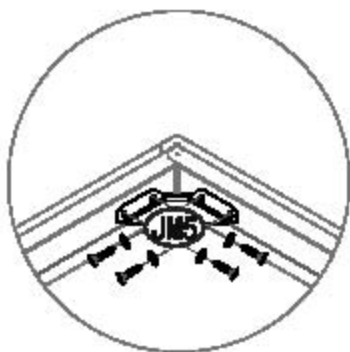

Telle / Parts	Nr. / No.	Stk. / Qty.
	JMS	4
	F1	16
	V2	16

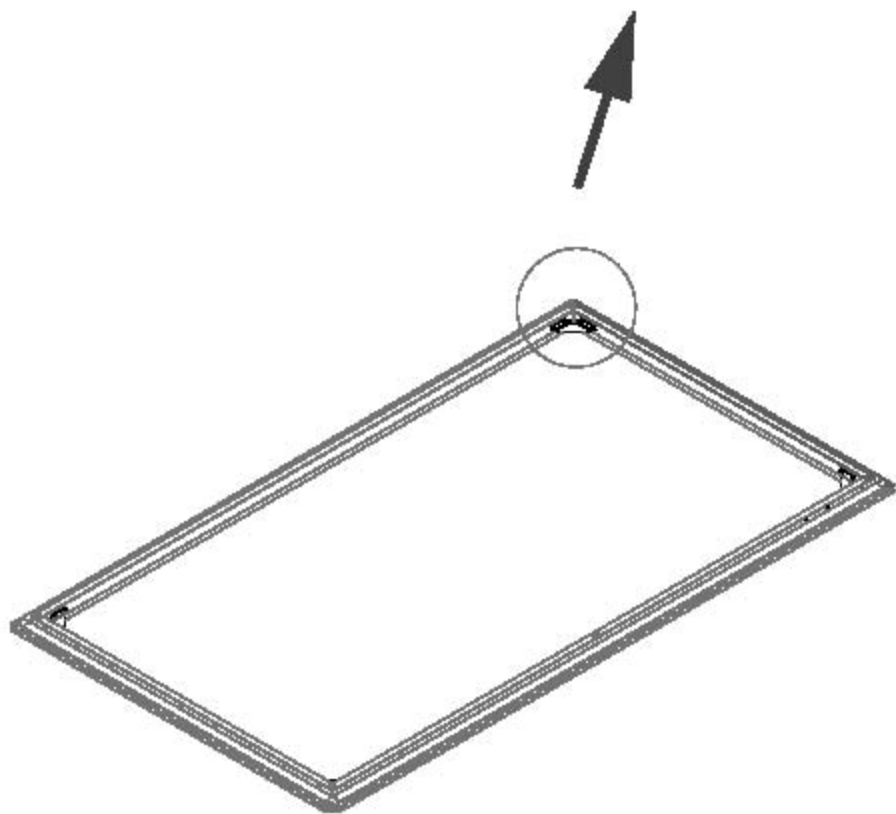

X4





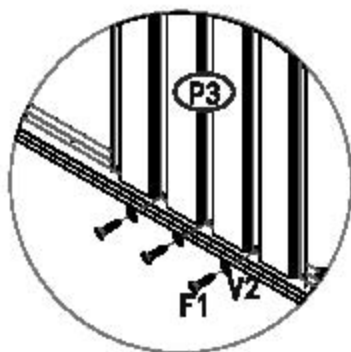
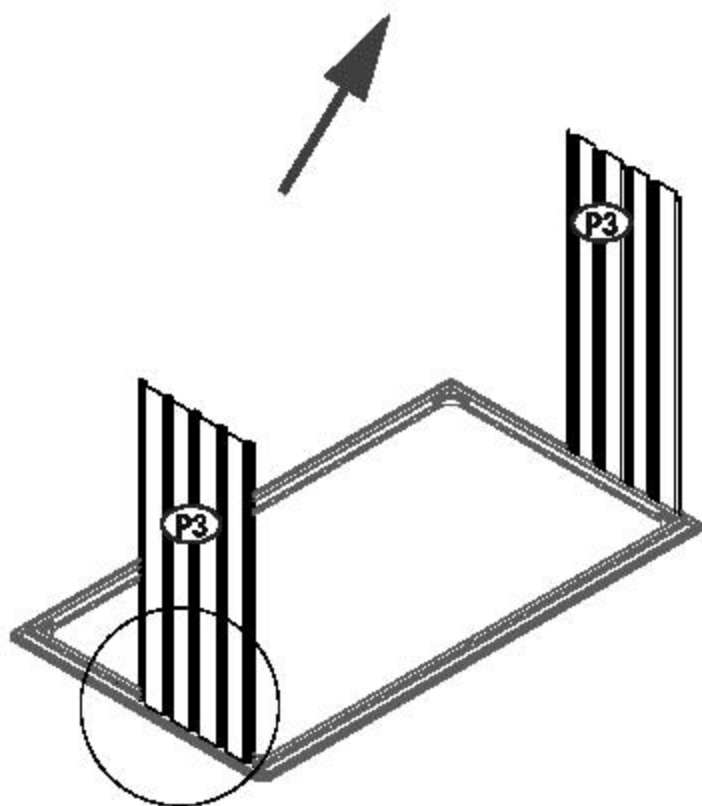

4.

Telle / Parts	Nr. / No.	Stk. / Qty.
	P3	2
	F1	6
	V2	6



**X2**

5.

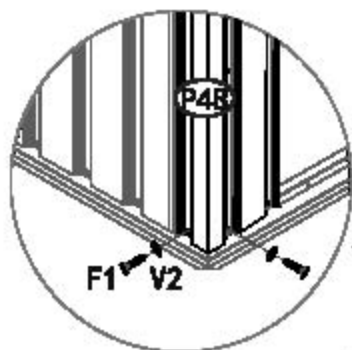
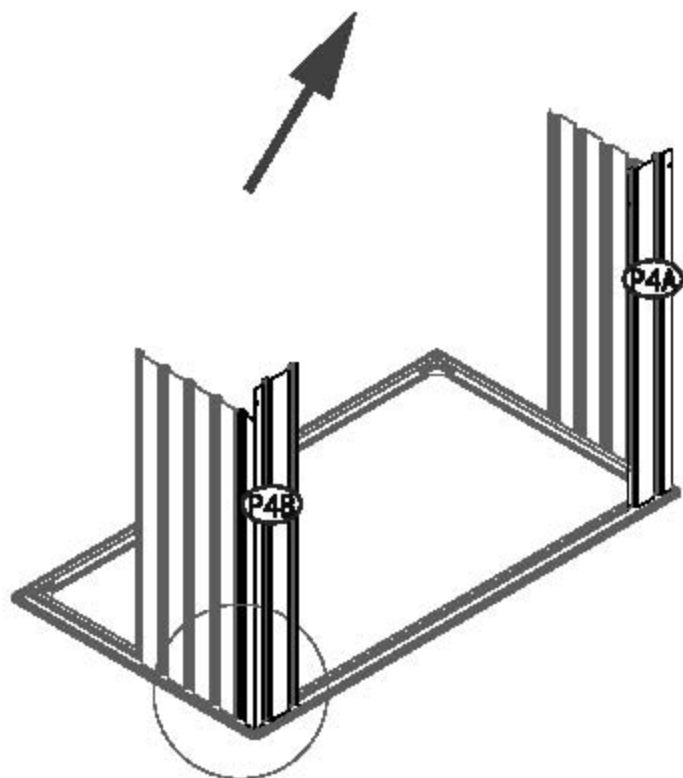
Teil / Parts	Nr. / No.	Stk. / Qty.
	P4B	1
	P4A	1
	F1	2
	V2	2



**X2**

6.

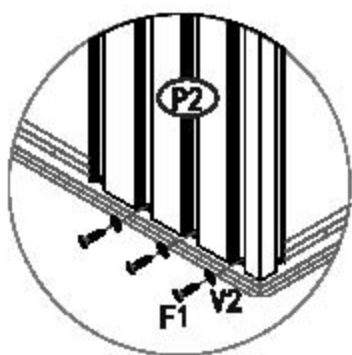
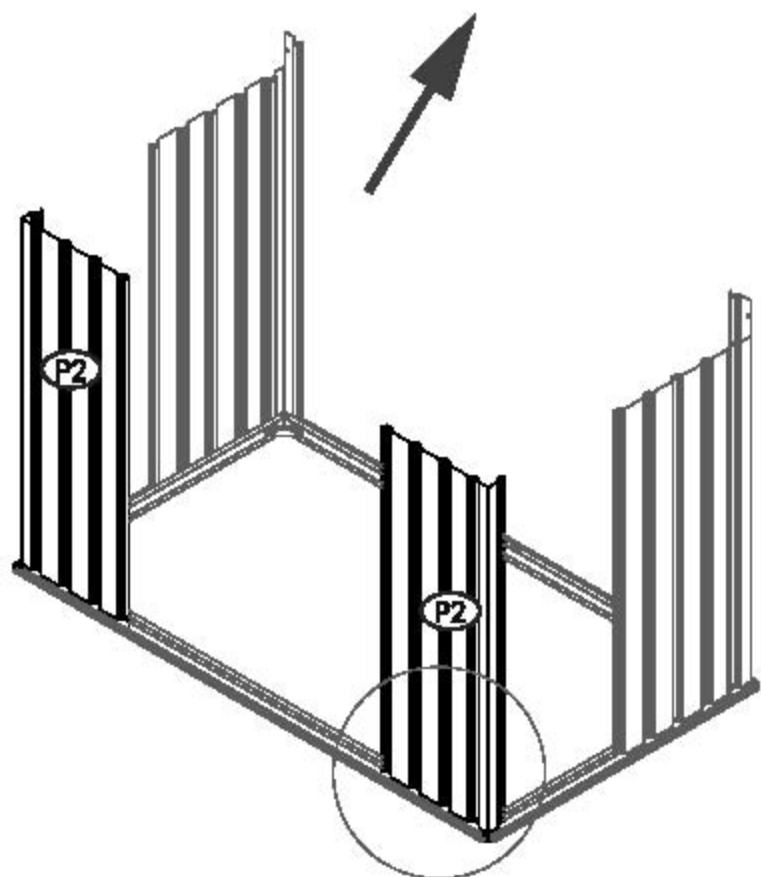
Teile / Parts	Nr. / No.	Stk. / Qty.
	P2	2
	F1	6
	V2	6



**X2**

7.

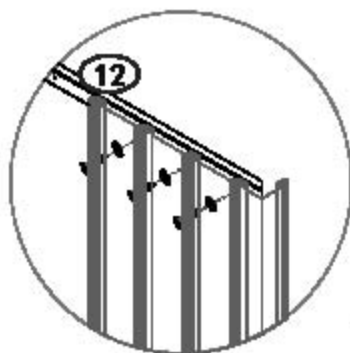
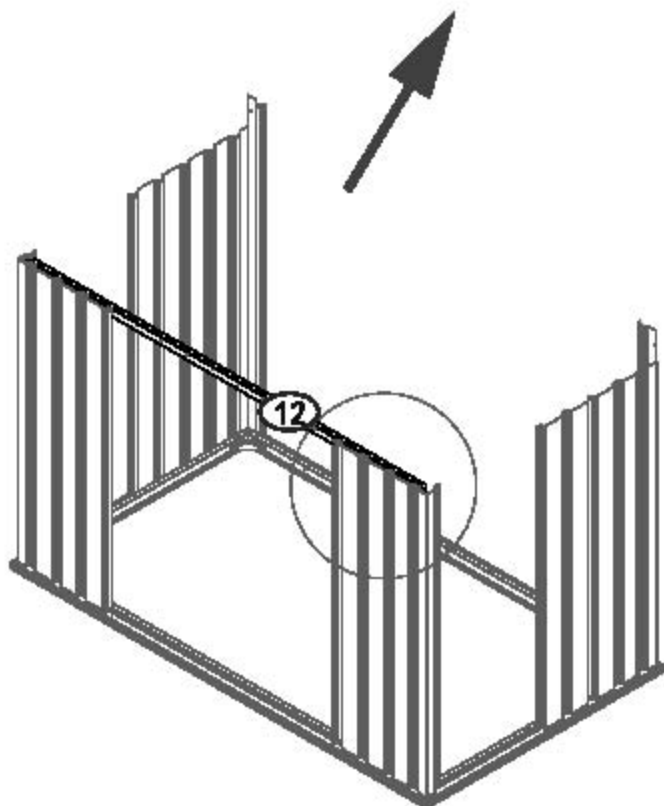
Teile / Parts	Nr. / No.	Stk. / Qty.
	12	1
	F1	6
	V2	6



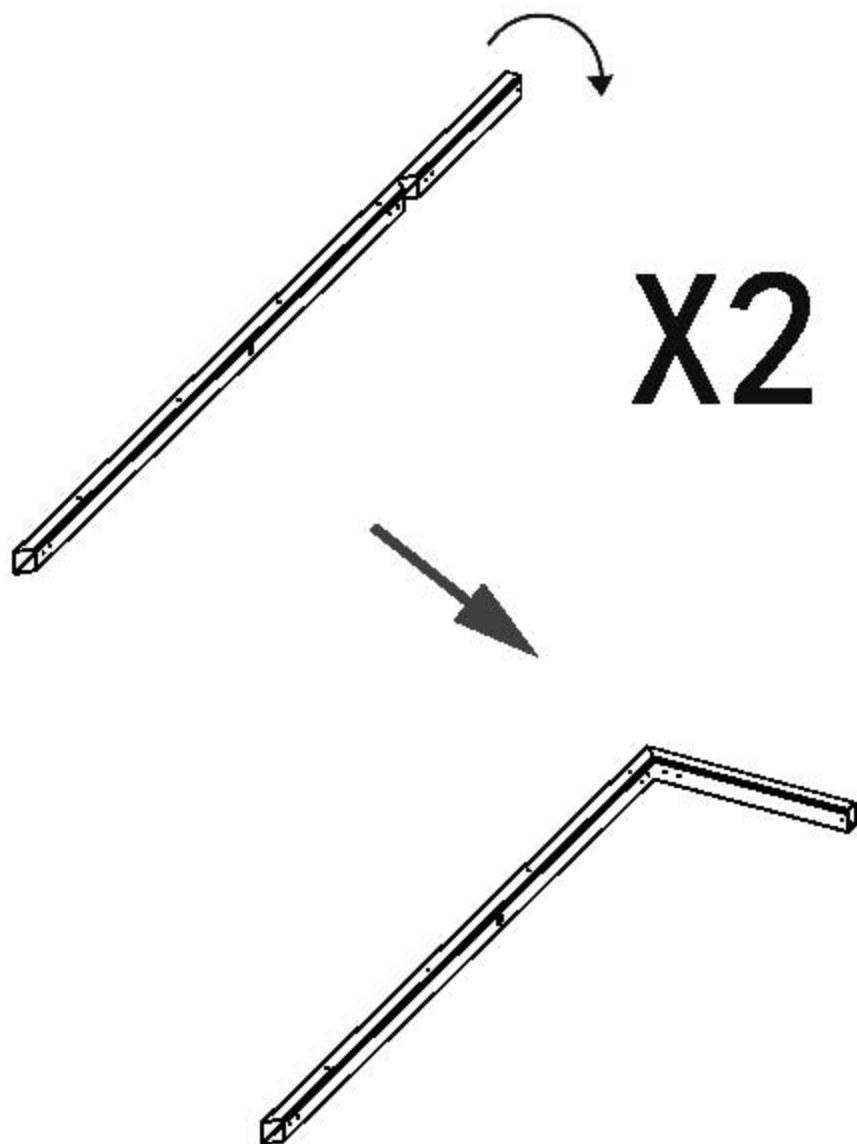

**X2**

8.

Telle / Parts	Nr. / No.	Stk. / Qty.
	11L	1
	11R	1



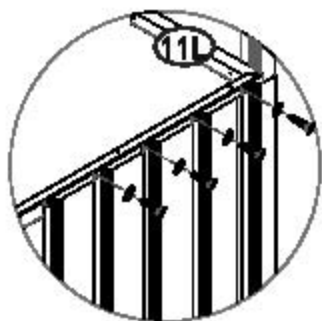
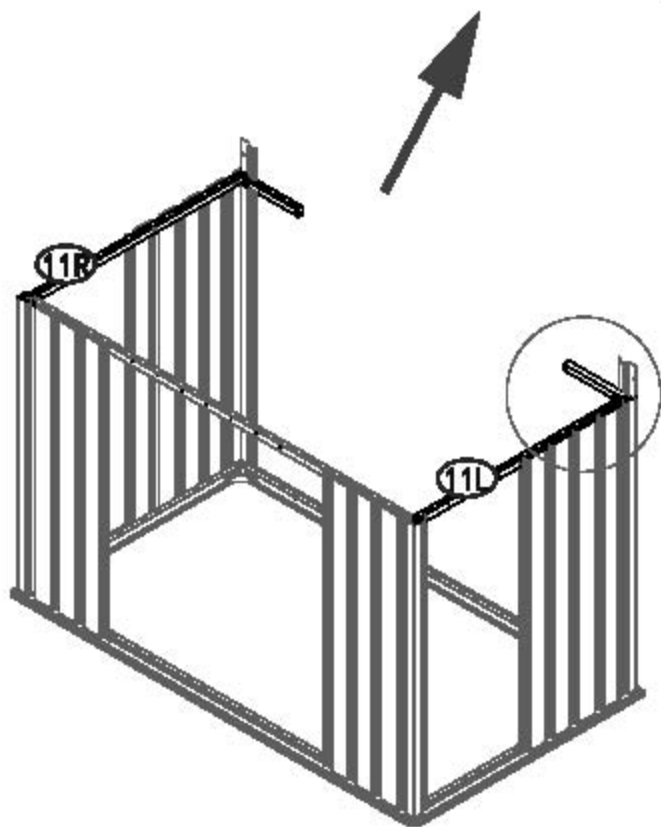

9.

Tela / Parts	Nr. / No.	Stk. / Qty.
	11L	1
	11R	1
	F1	4
	V2	4



**X2**

10.

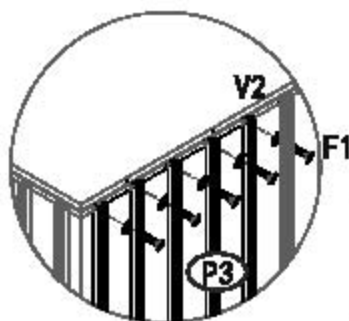
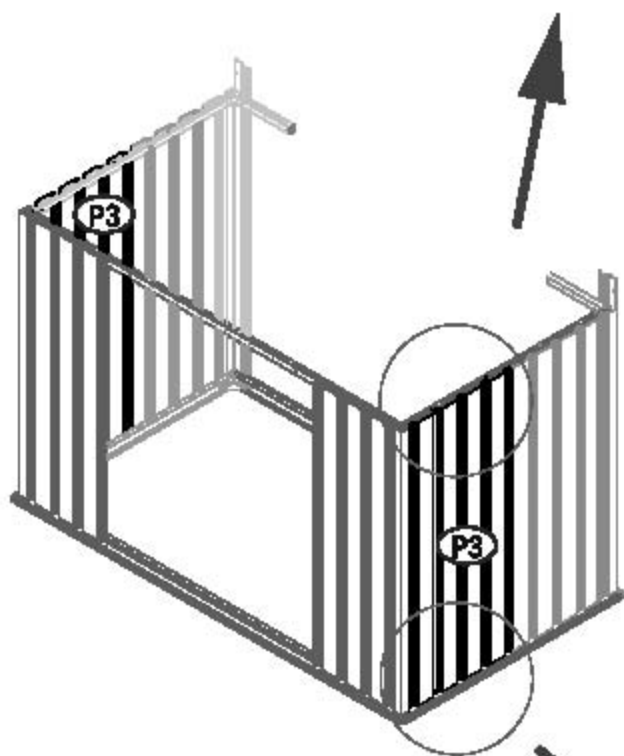
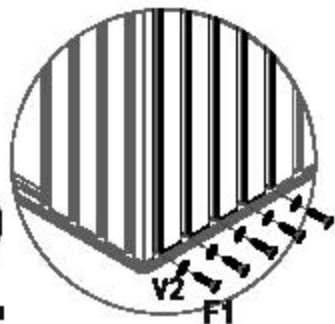
Teile / Parts	Nr. / No.	Stk. / Qty.
	P3	2
	F1	20
	V2	20



**X2****X2**

11.

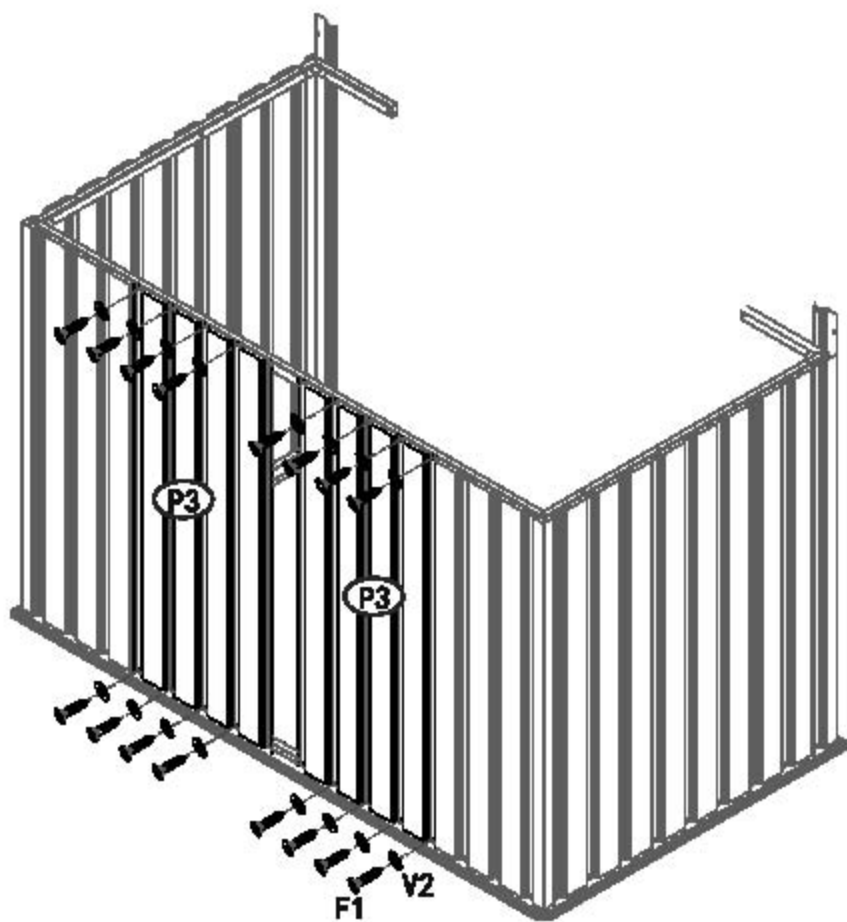
Telle / Parts	Nr. / No.	Stk. / Qty.
	P3	2
	F1	16
	V2	16



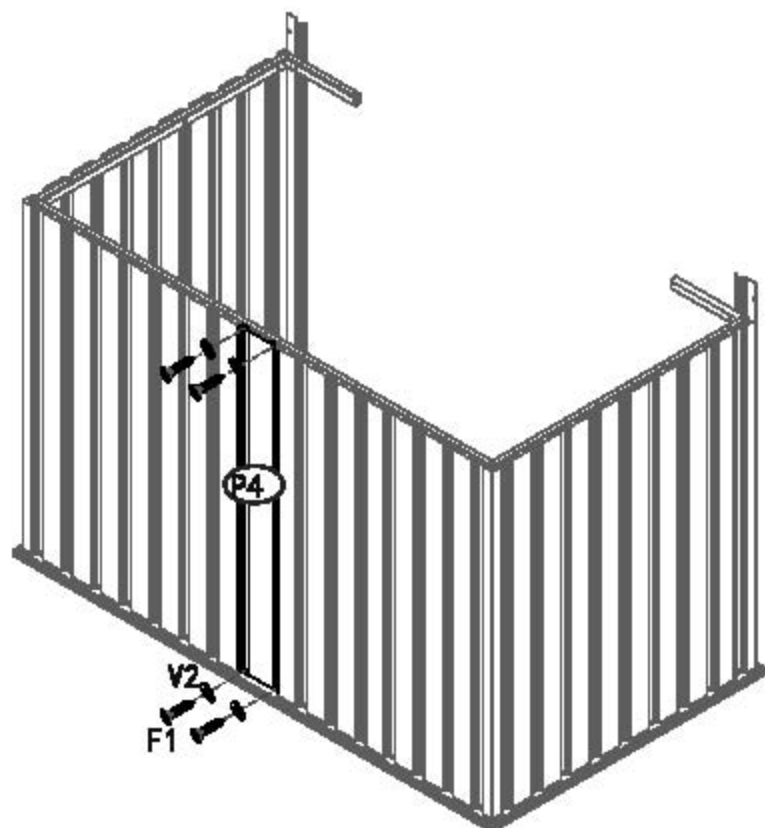

12.

Talle / Parts	Nr. / No.	Stk. / Qty.
	P4	1
	F1	4
	V2	4





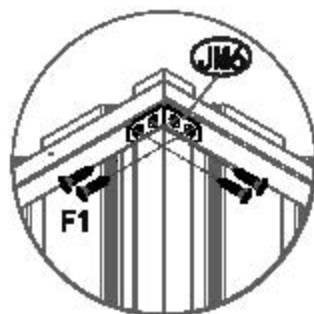
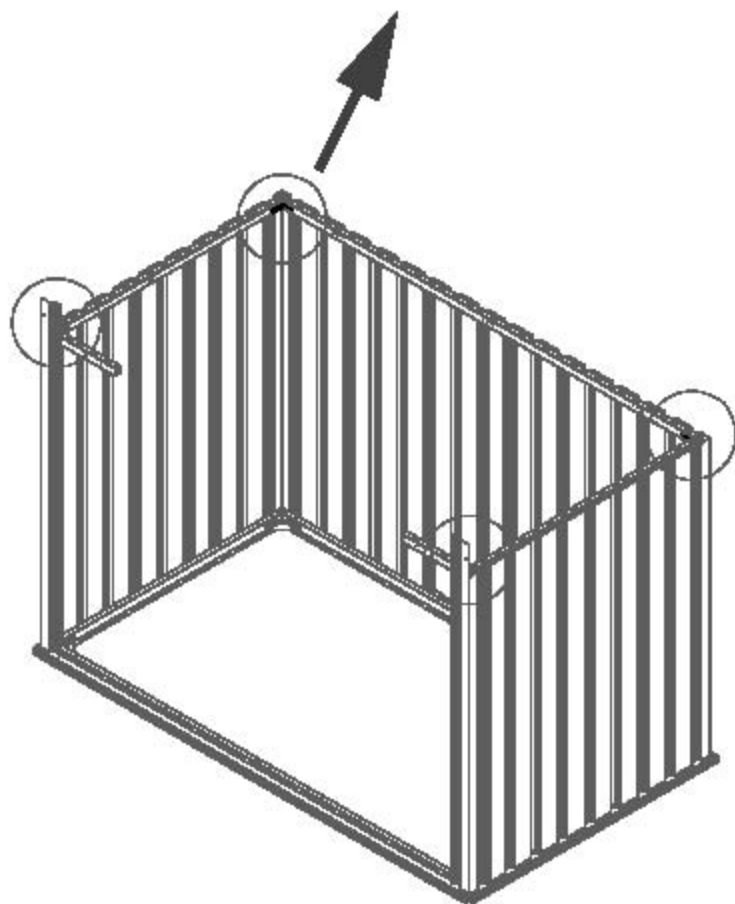

13.

Teile / Parts	Nr. / No.	Stk. / Qty.
	JM6	4
	F1	16

**X4**

14.

Teile / Parts	Nr. / No.	Stk. / Qty.
	29R	1
	29L	1
	F1	8
	V2	8



X2

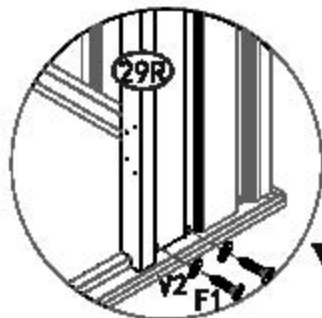
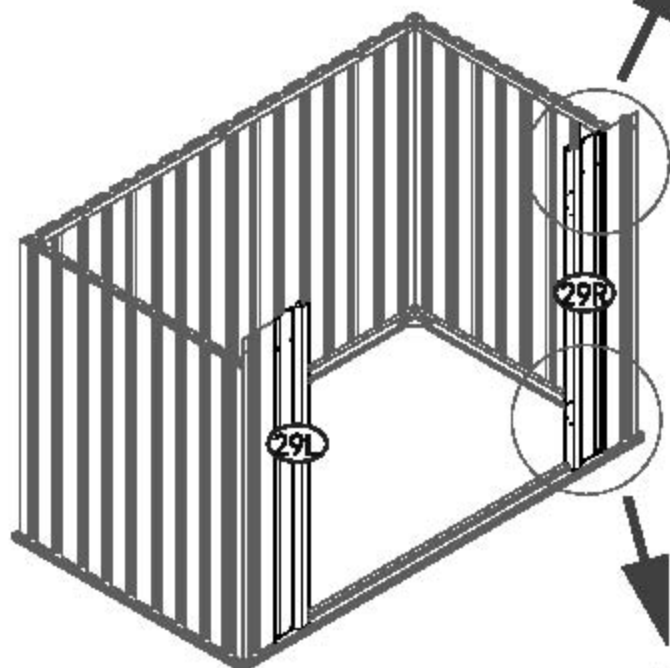



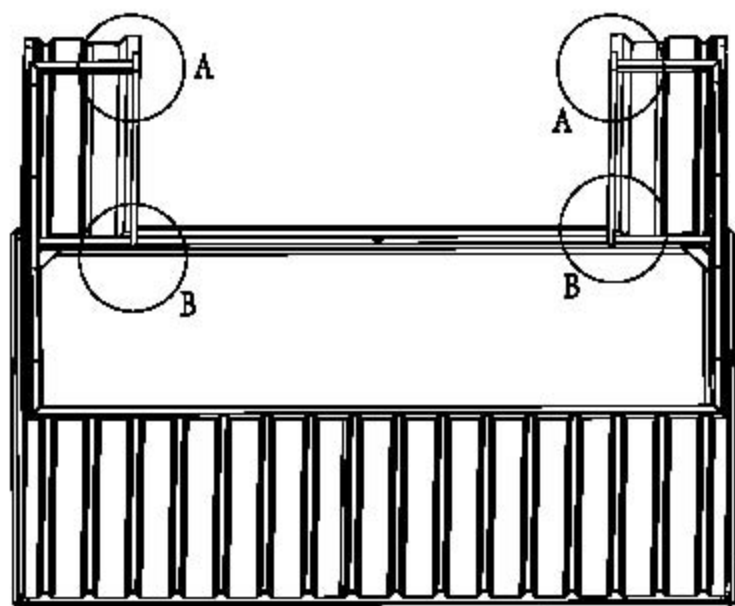
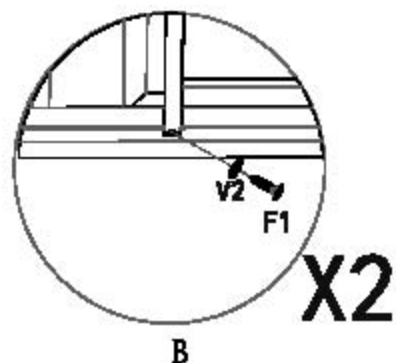
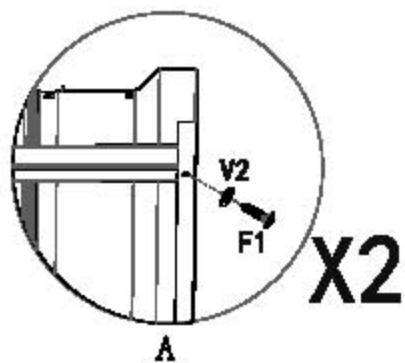

X2

15.

Tela / Parts	Nr. / No.	Stk. / Qty.
	F1	4
	V2	4



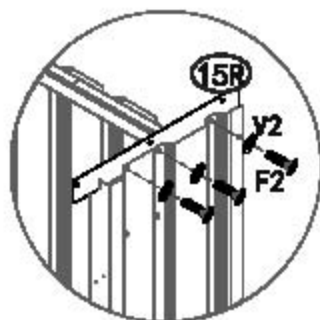
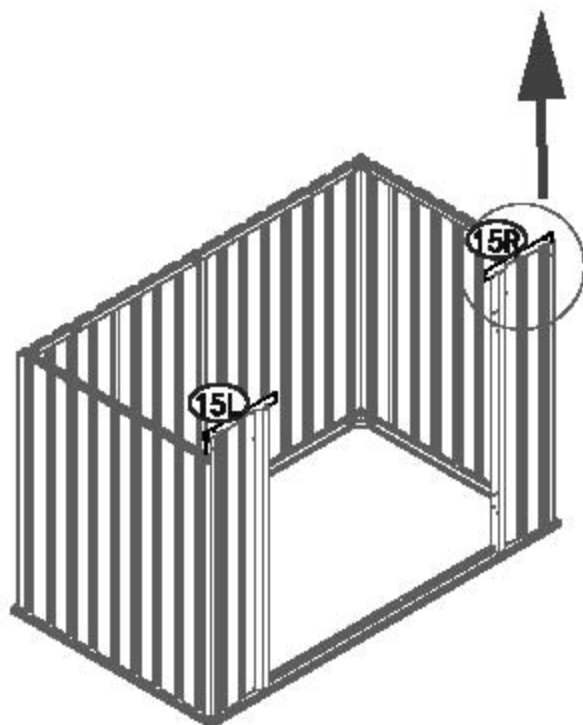

16.

Teile / Parts	Nr. / No.	Stk. / Qty.
	15R	1
	15L	1
	F2	6
	V2	6

**X2**



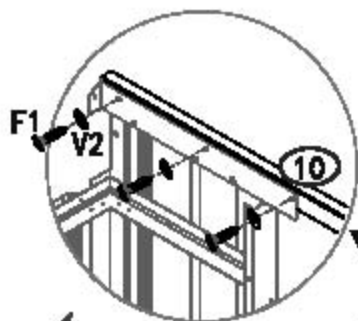
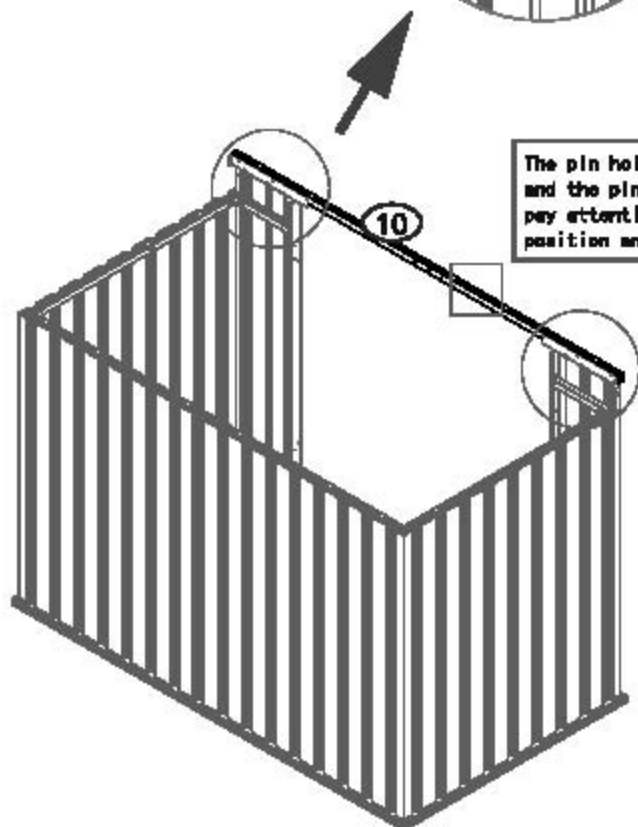

17.

Telle / Parts	Nr. / No.	Sck. / Qty.
	10	1
	F1	6
	V2	6

**X2**

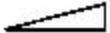

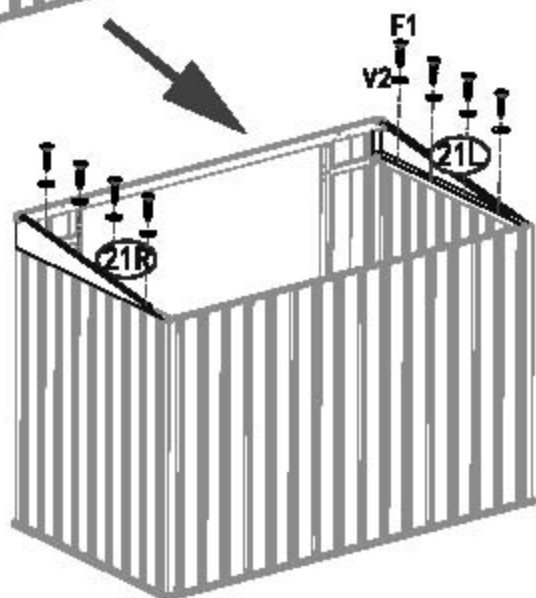
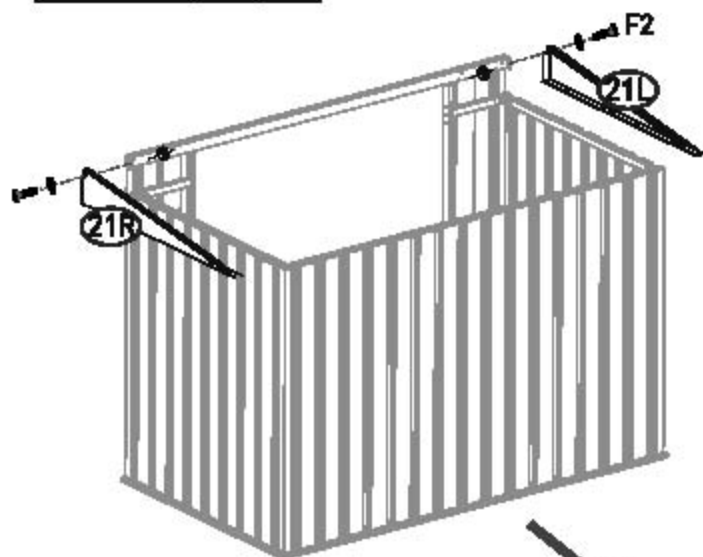

The pin hole is on the left door, and the pin hole on 10 should pay attention to the installation position and incline to the left side

18.

Teille / Parts	Nr. / No.	Stk. / Qty.
	21L	1
	21R	1
	F1	8
	F2	2
	V2	10



19.

Telle / Parts	Nr. / No.	Stk. / Qty.
	9	1
	F1	3
	F2	2
	V2	3

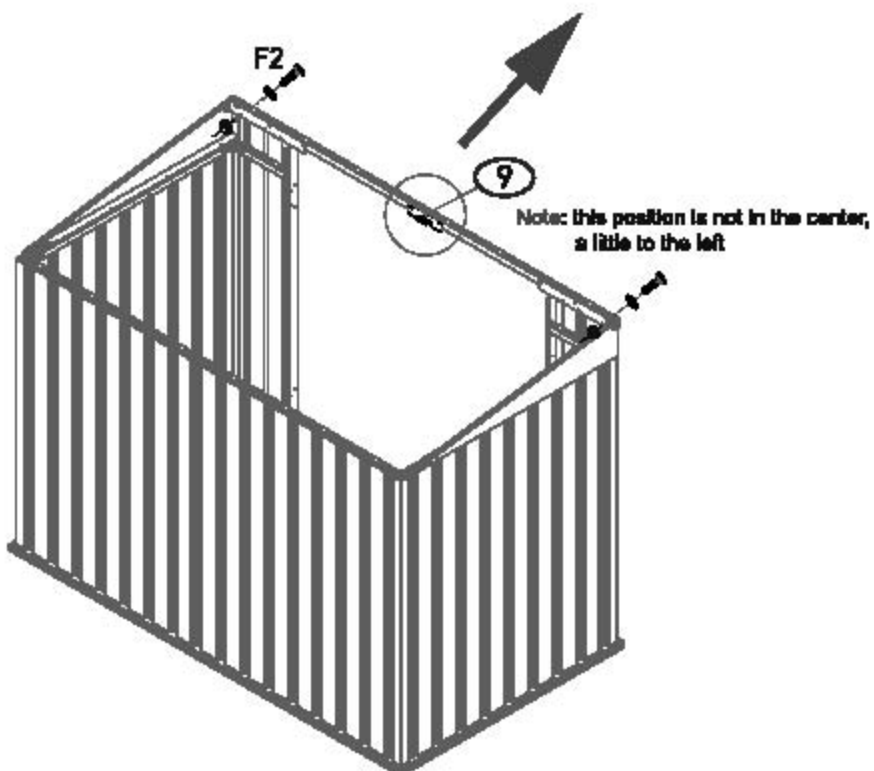
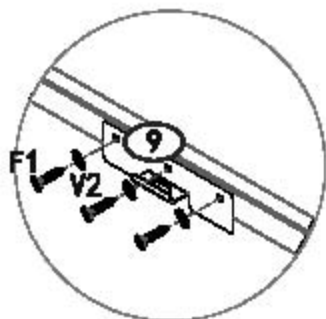

20.

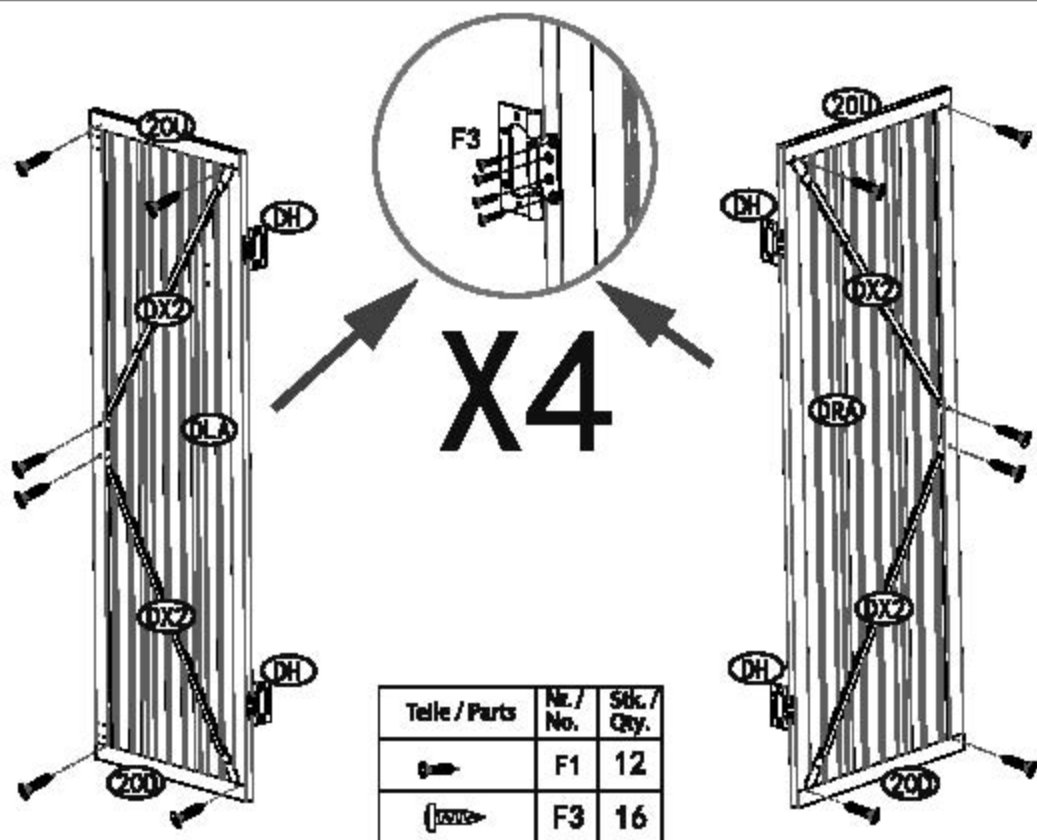
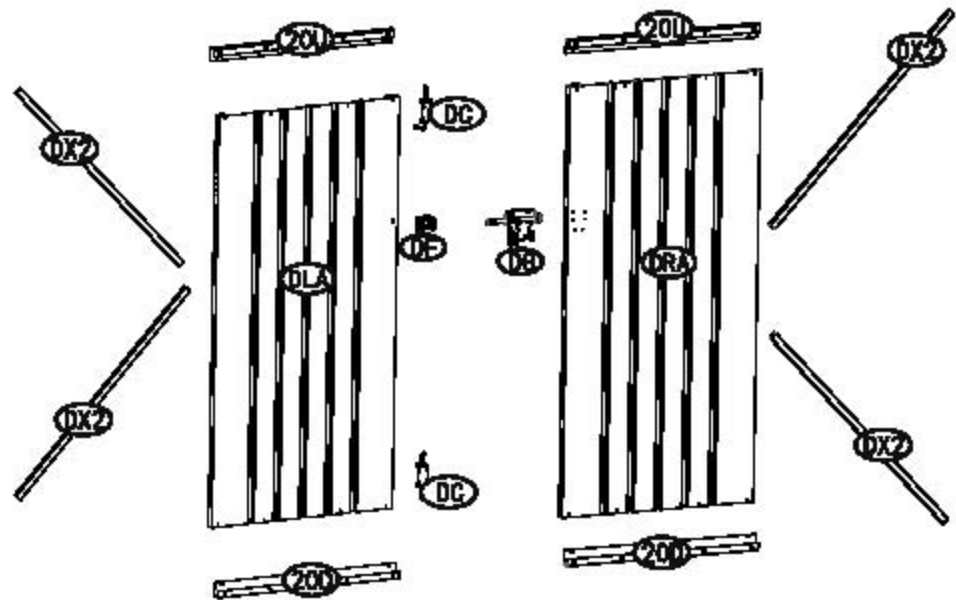

21.

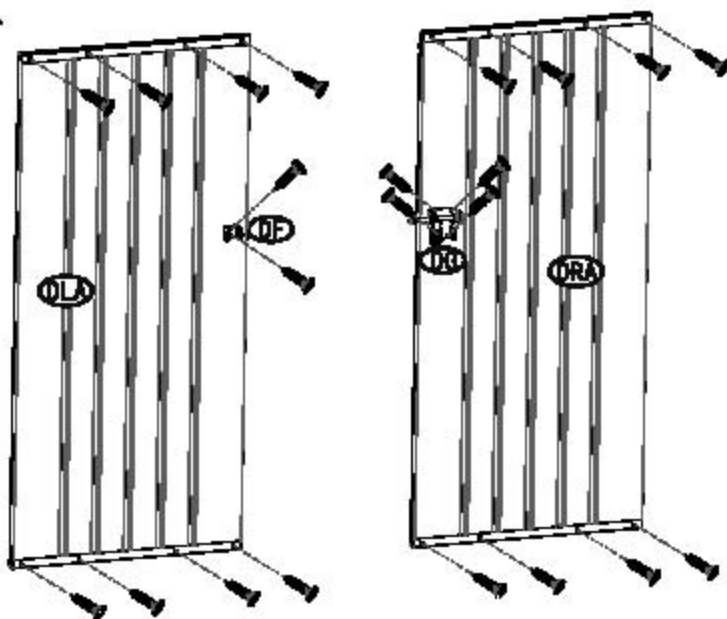

Telle / Parts	Nr. / No.	Stk. / Qty.
	F1	22

Telle / Parts	Nr. / No.	Stk. / Qty.
	F1	8

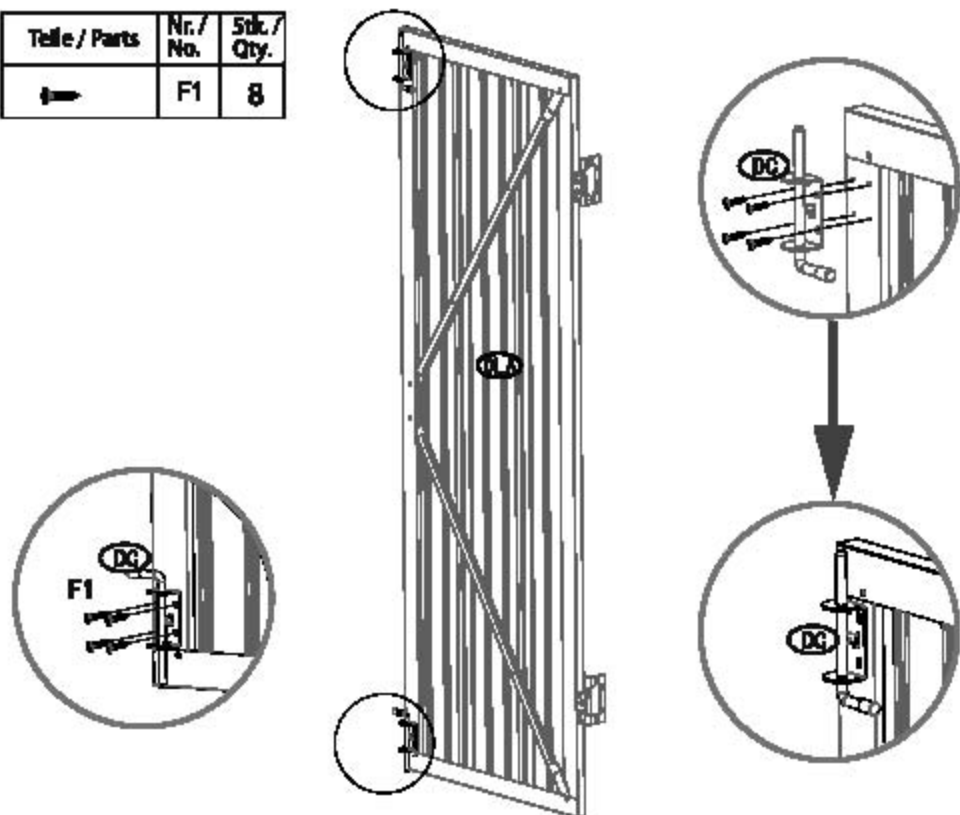

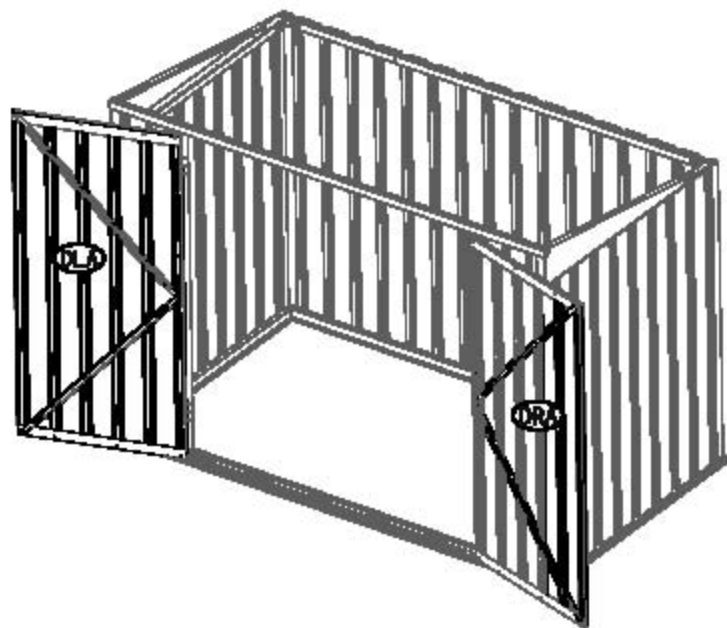
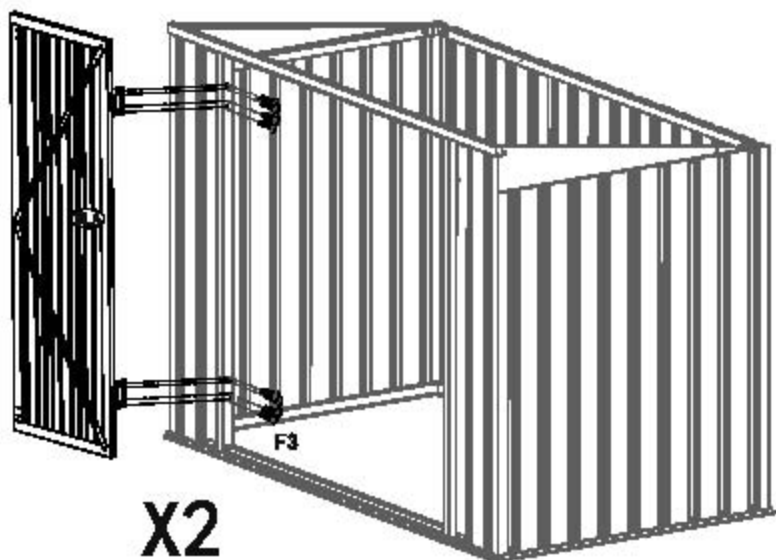

22

Teile / Parts	Nr. / No.	Stk. / Qty.
	F3	16

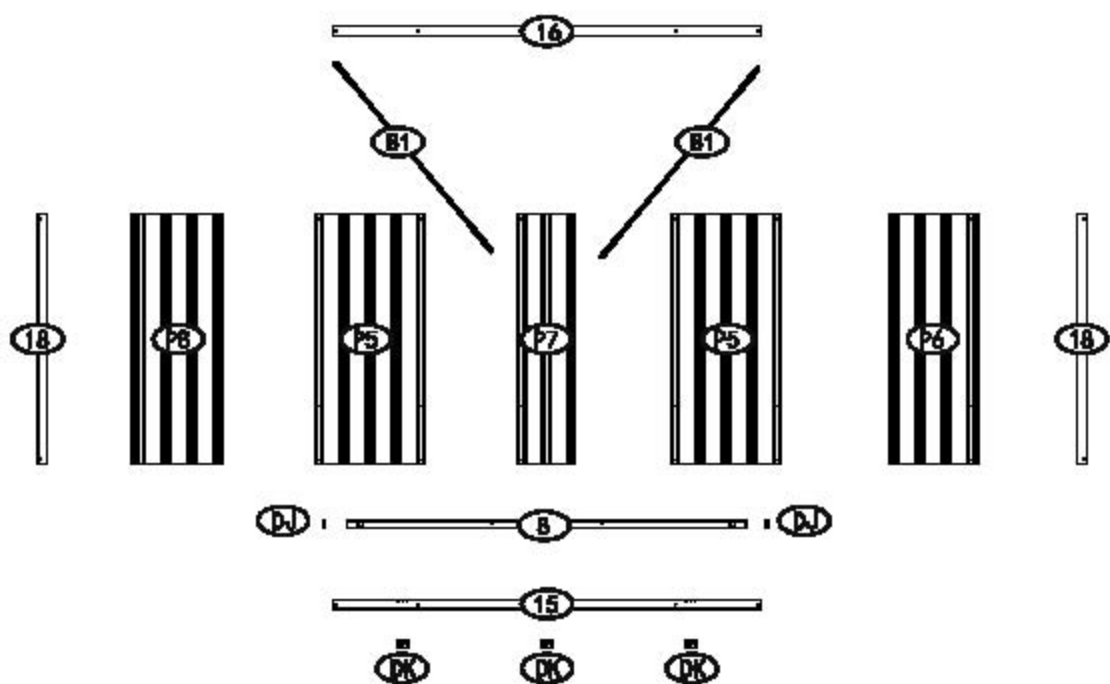



24.

Telle / Parts	Nr. / No.	Stk. / Qty.
	F1	33
	Y2	33

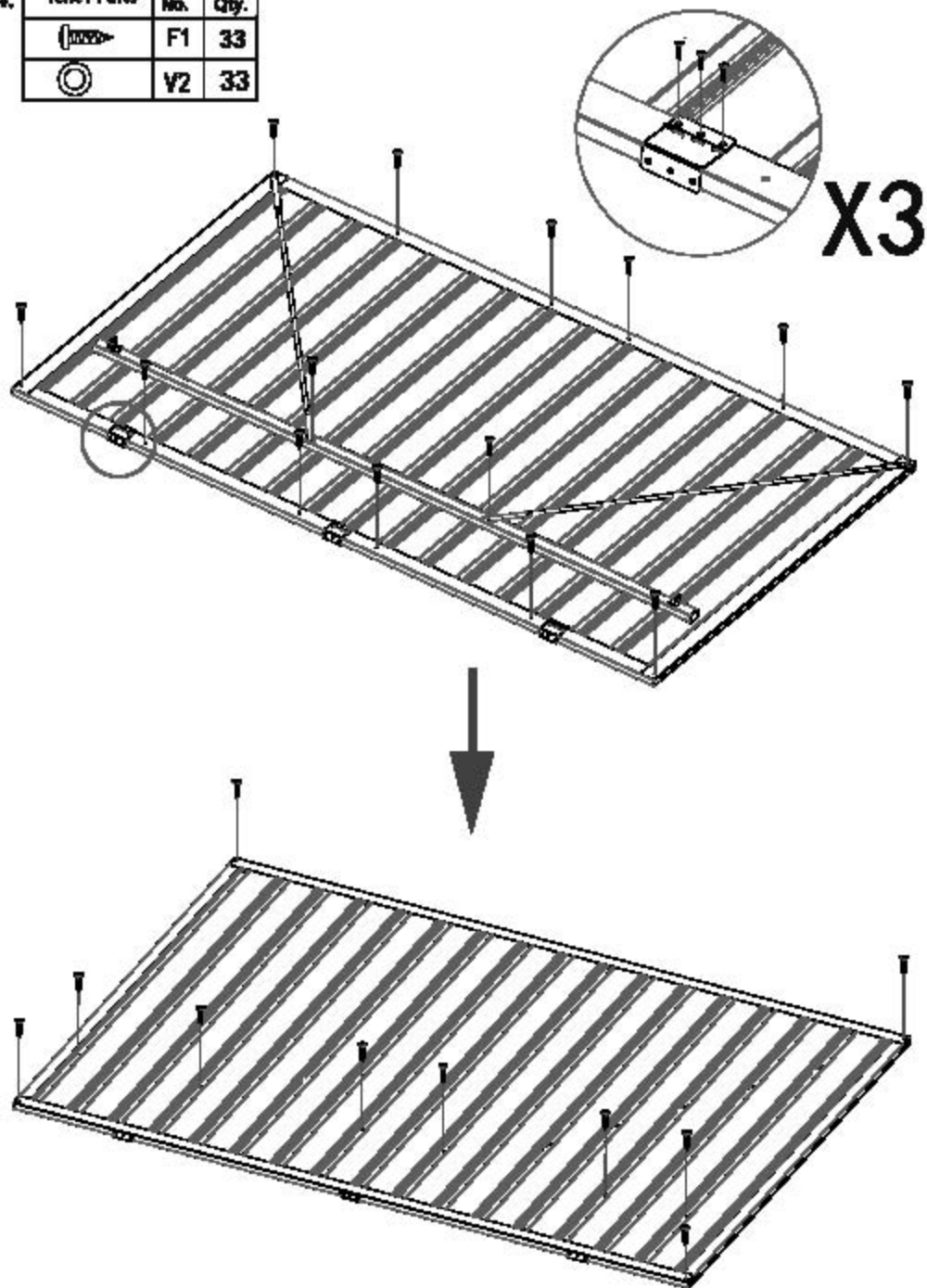

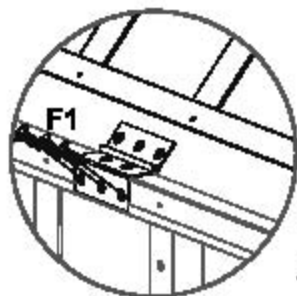
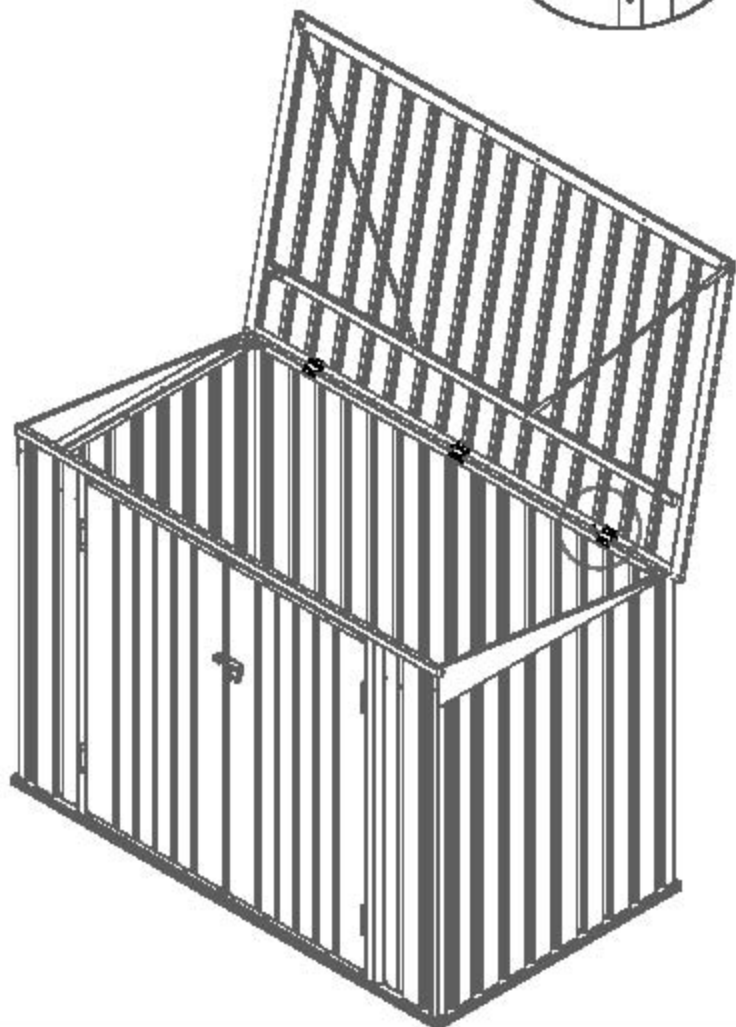

25.

Telle / Parts	Nr. / No.	Stk. / Qty.
	F1	9

**X3**

26.

Table / Parts	Nr. / No.	Set. / Qty.
	G3	2
	M8	2

Tighten the bolts with a wrench according to the position shown in the figure

