

*Japan*  
*Art. Nr. 4424702*  
*1/12*

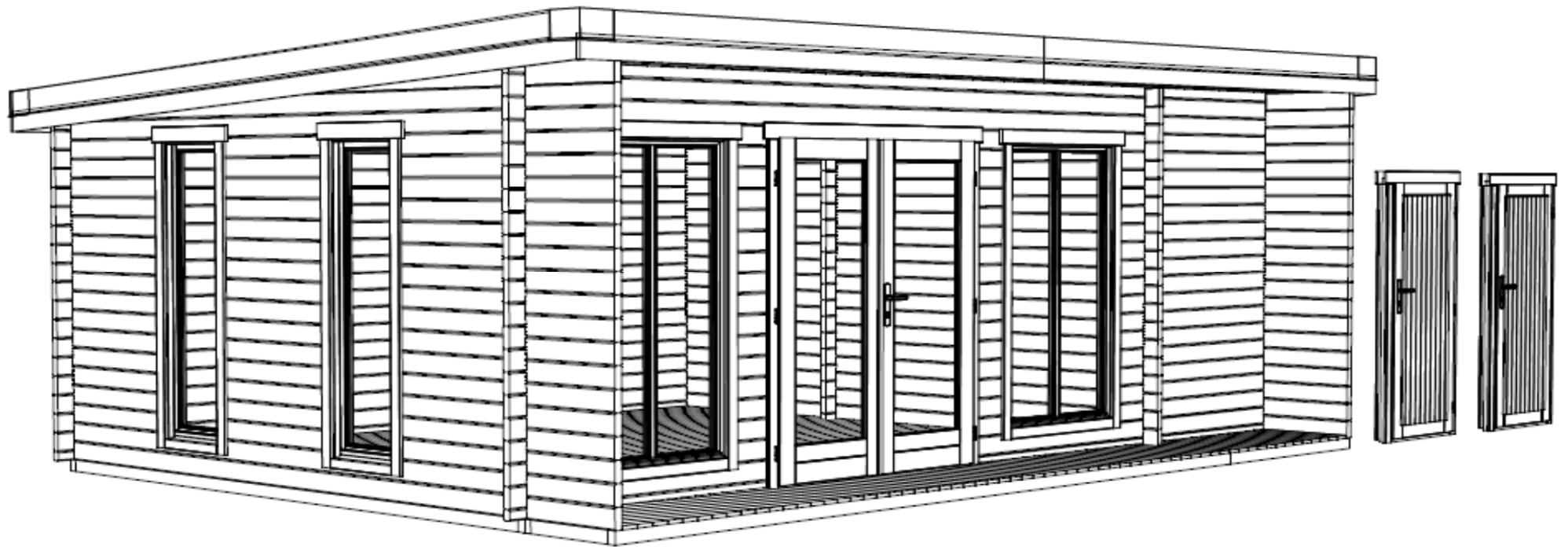

Art. Nr. 4424702

Groundplan - Grundplan - Plan de masse - Planimetria - Plattegrond -  
Põhiplaan

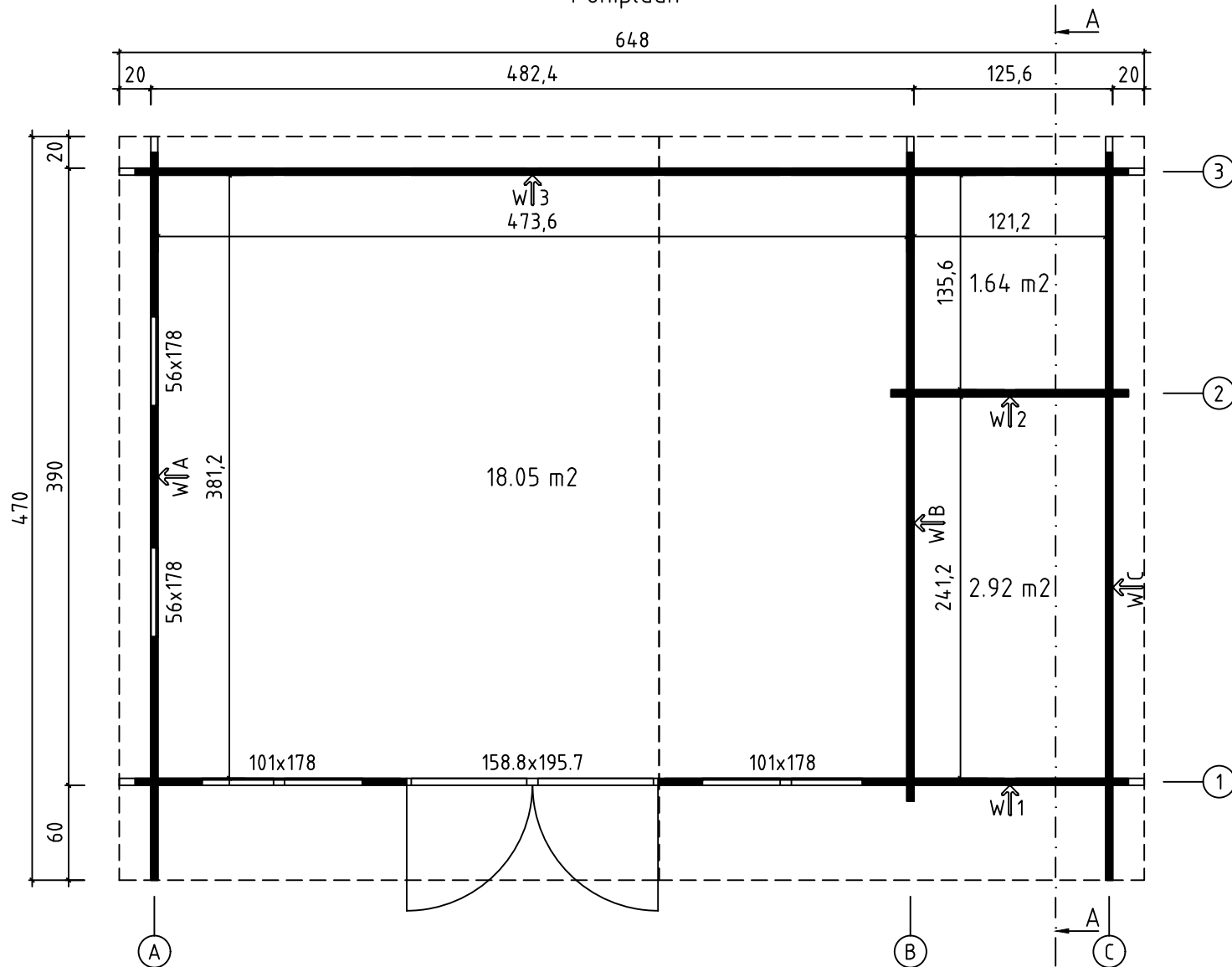

Art. Nr. 4424702

Foundation - Fundament - Fondation - Fundamenta - Fundering - Immutatud  
alusraam

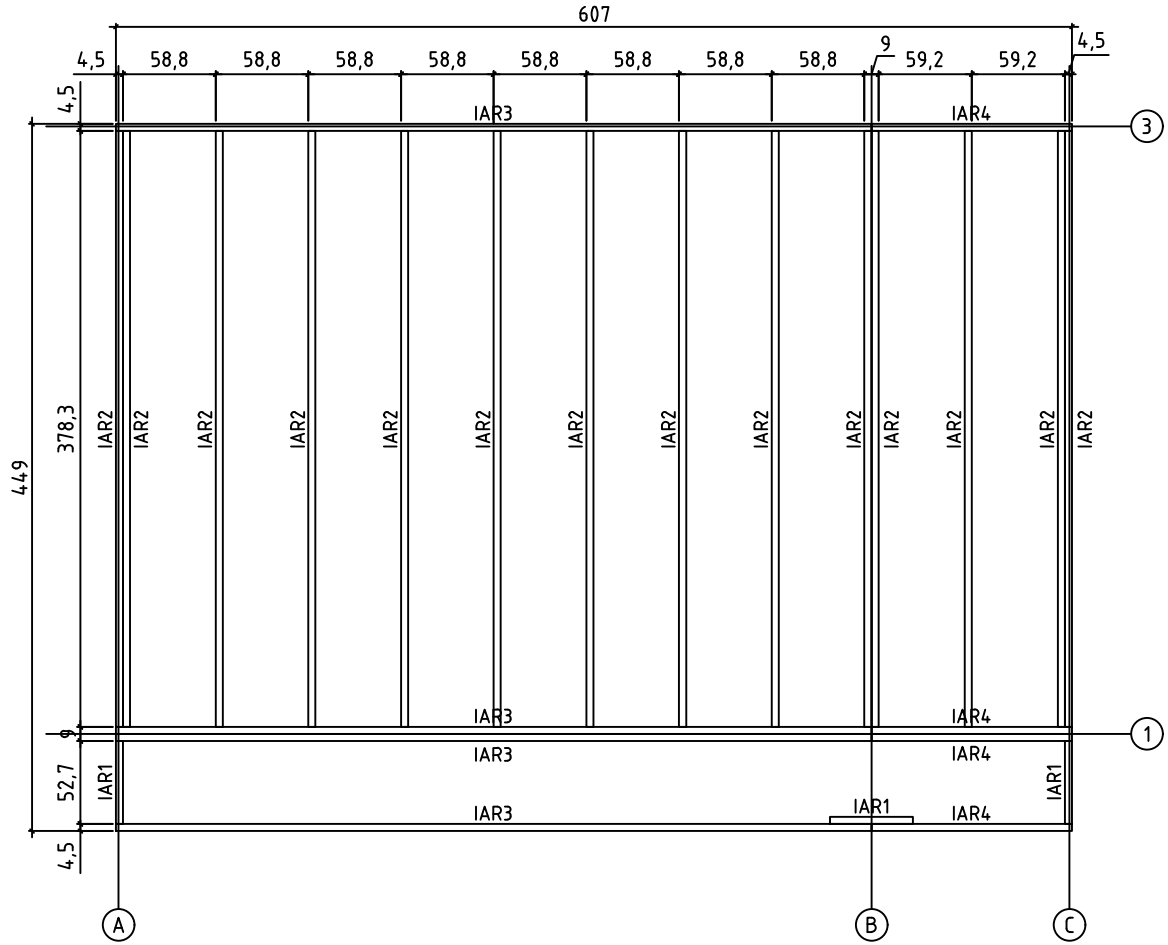

Floor boards - Fussbodenbretter - Plan pose plancher - Pavimento - Vloerhout - Põrandalaudis  
Terrace boards - Terrassenbretter - Plancher de terrasse - Piattaforme terrazzo - Terrasvloer - Terrassilaudis

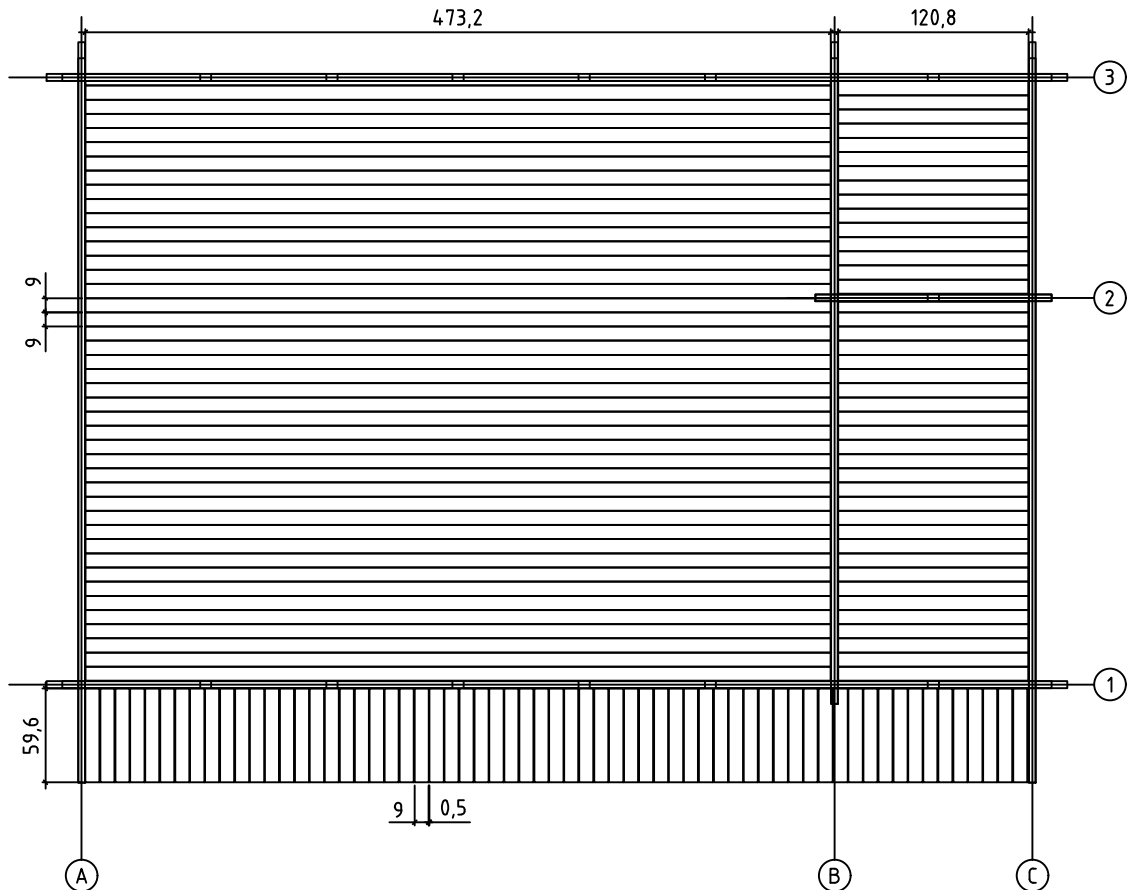

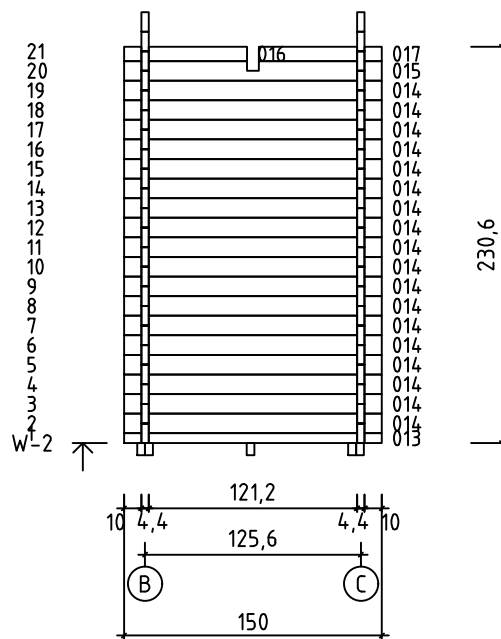
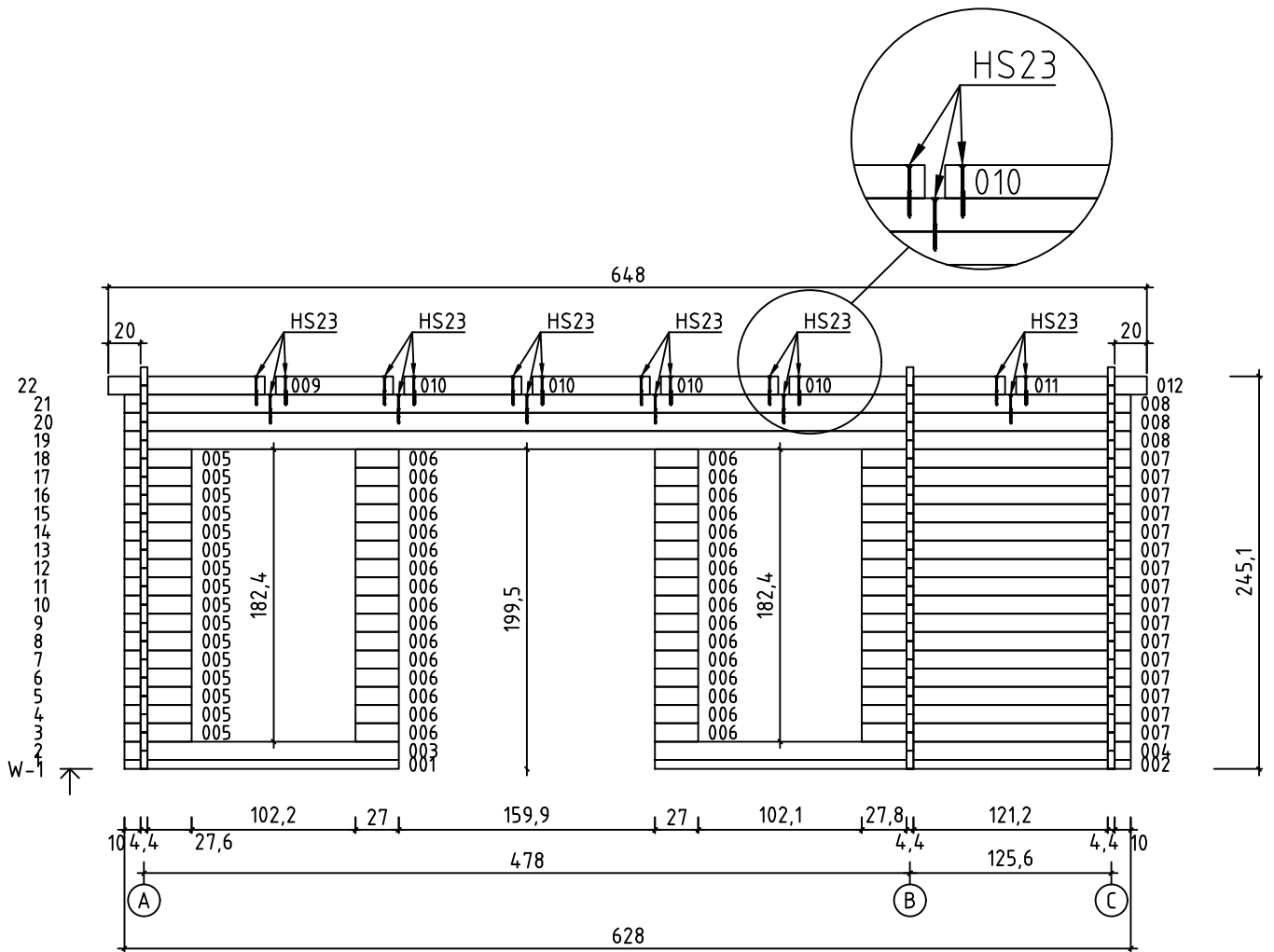

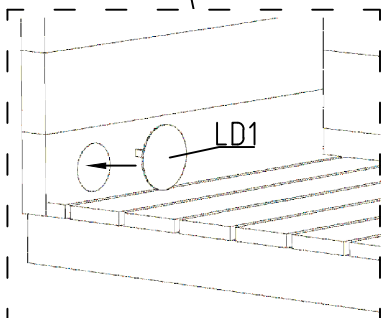
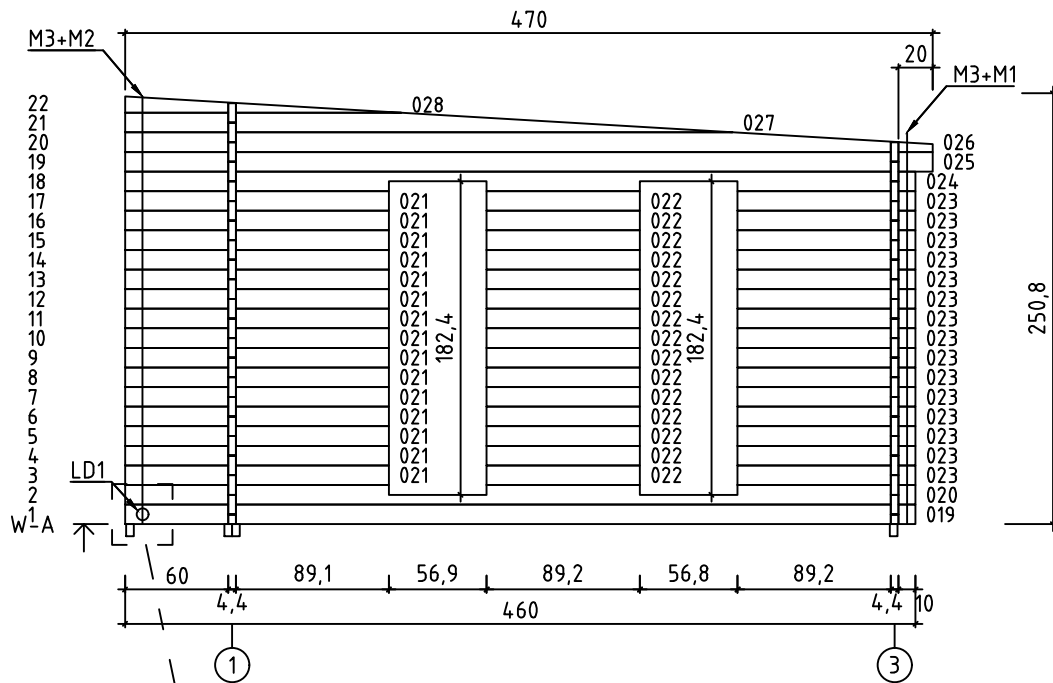
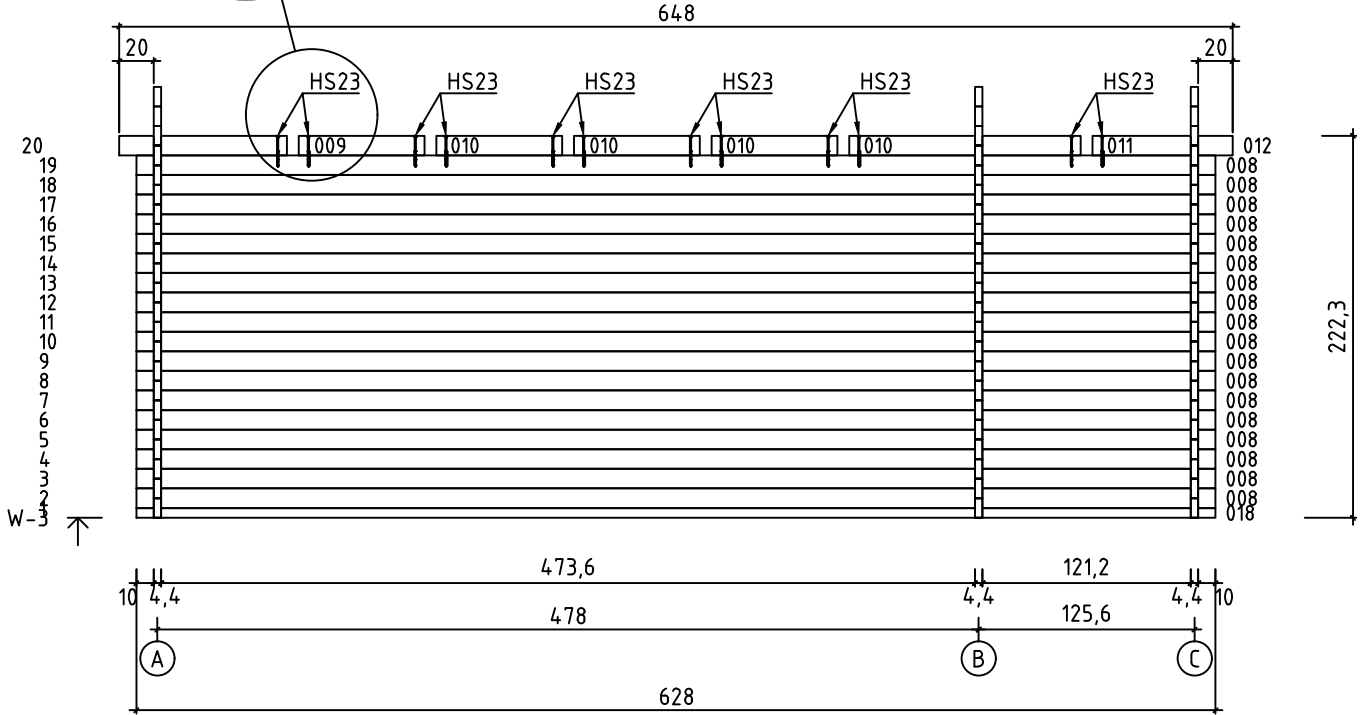
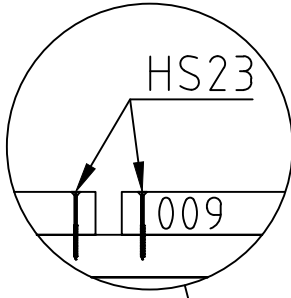

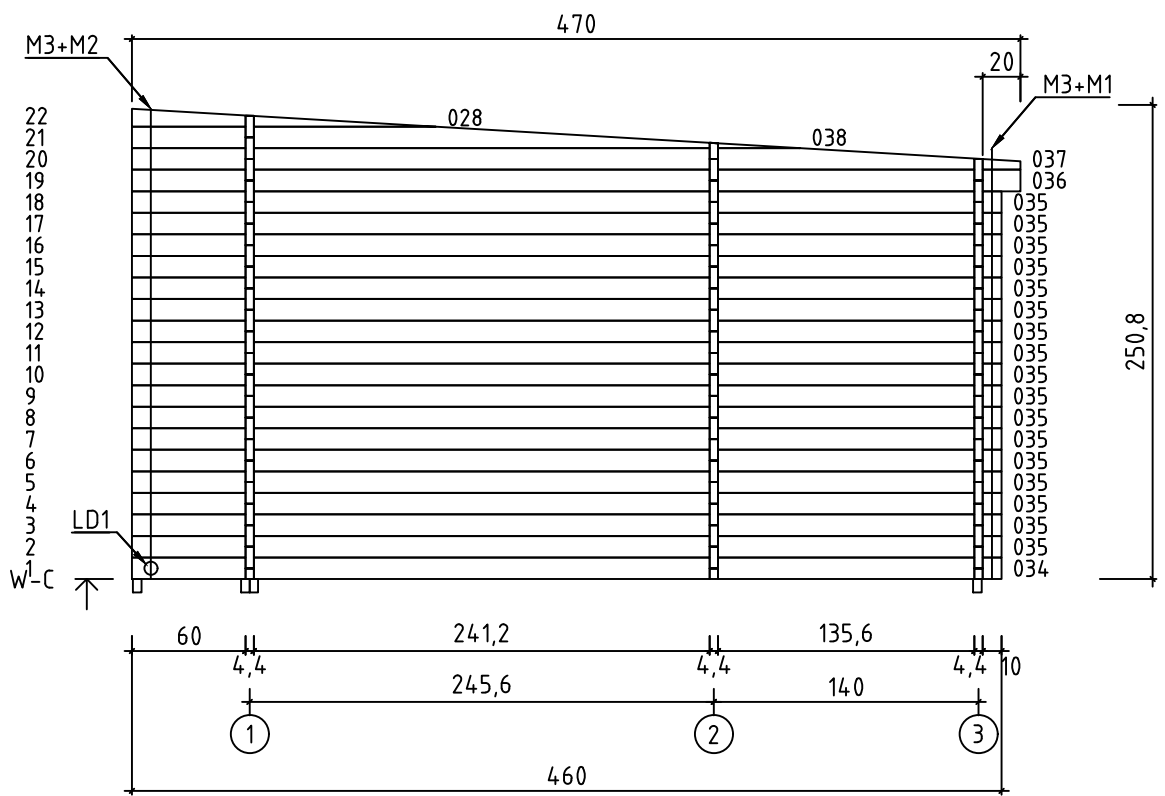
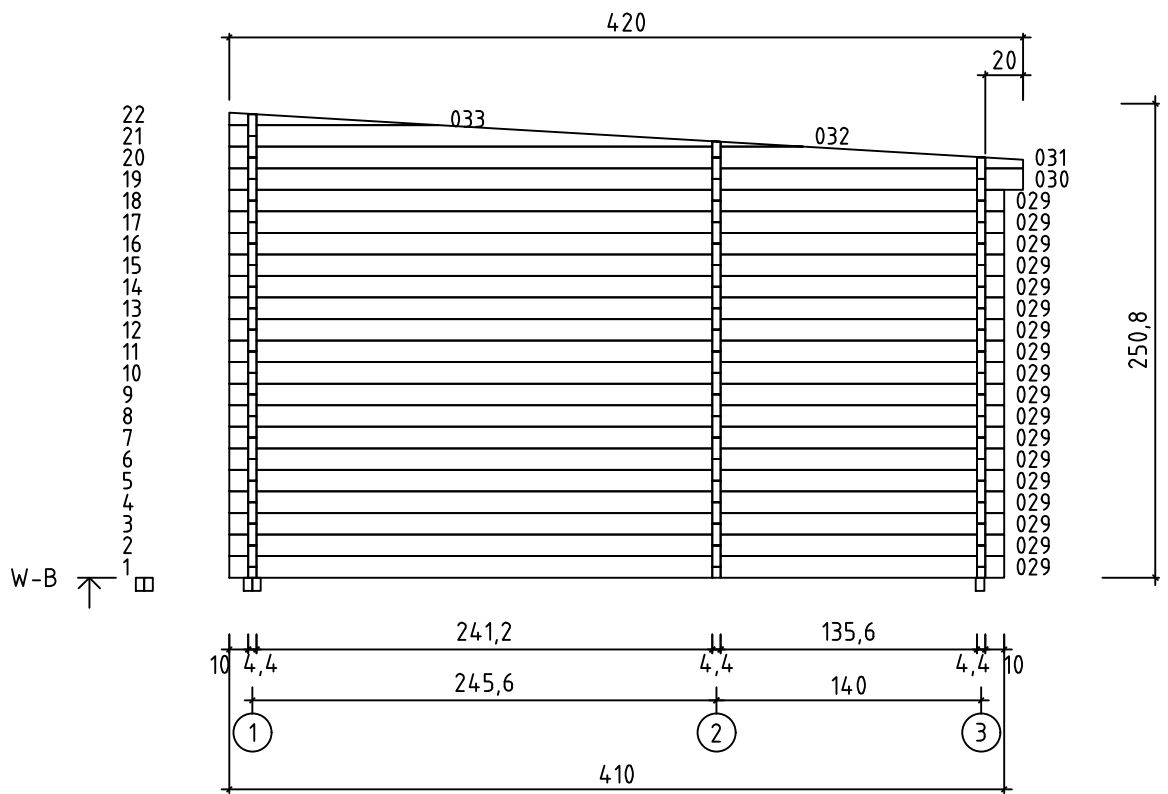

A single door (83.5x190 cm) has been delivered together with the building. You can choose the location for the door by yourself by cutting the wall logs as shown in the picture (see the dotted line).

Eine Einzeltür (83.5 x 190 cm) ist im Lieferumfang enthalten. Über die Positionierung der Tür entscheiden Sie selbst, indem Sie den Ausschnitt für die Tür in Eigenregie einschneiden (siehe Bild unter der gestrichelten Linie).

Une porte simple (83.5x190 cm) est livree avec l'abri. Vous pouvez choisir l'endroit ou vous voulez monter la porte en decoupant les madriers tel qu'illustre dans le schema (voir ligne en pointilles).

Una porta singola (83.5x190 cm) é stata consegnata con la casa. Tu puoi scegliere la posizione della porta secondo il tuo gradimento. tagliando la parete come raffigurato nella fotografia (segui la linea tratteggiata).

Bij uw huisje is een losse enkele deur (83.5x190 cm) geleverd. U heeft hierin een vrije keuze waar u deze wilt inbouwen, door het inzagen van de wandbalk zoals op de tekening (zie de stippellijn).

Majakomplekt sisaldab kaks üksikust (83.5x190 cm), mille asukoht on võimalik ise valida. Ukseava tuleb lõigata joonisel näidatud mõõtudes (vaadake punktiirjooni).

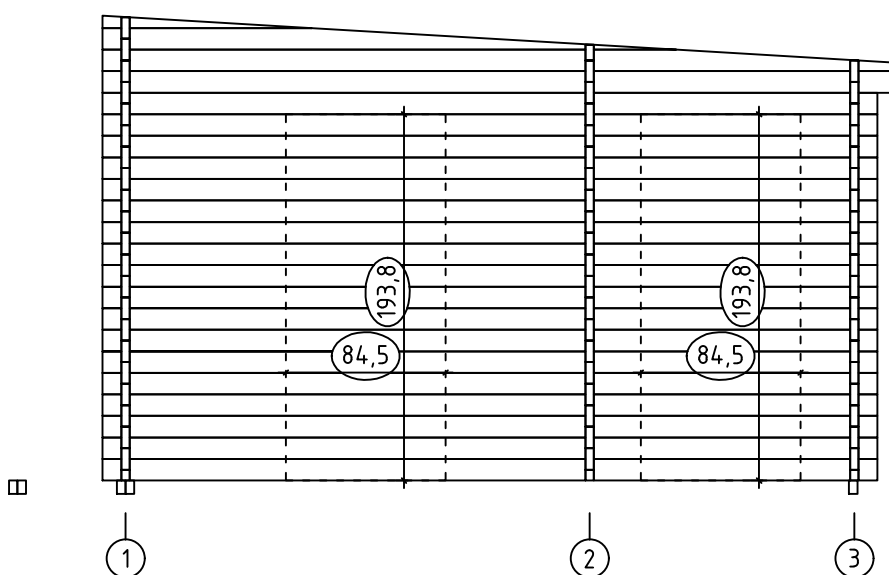

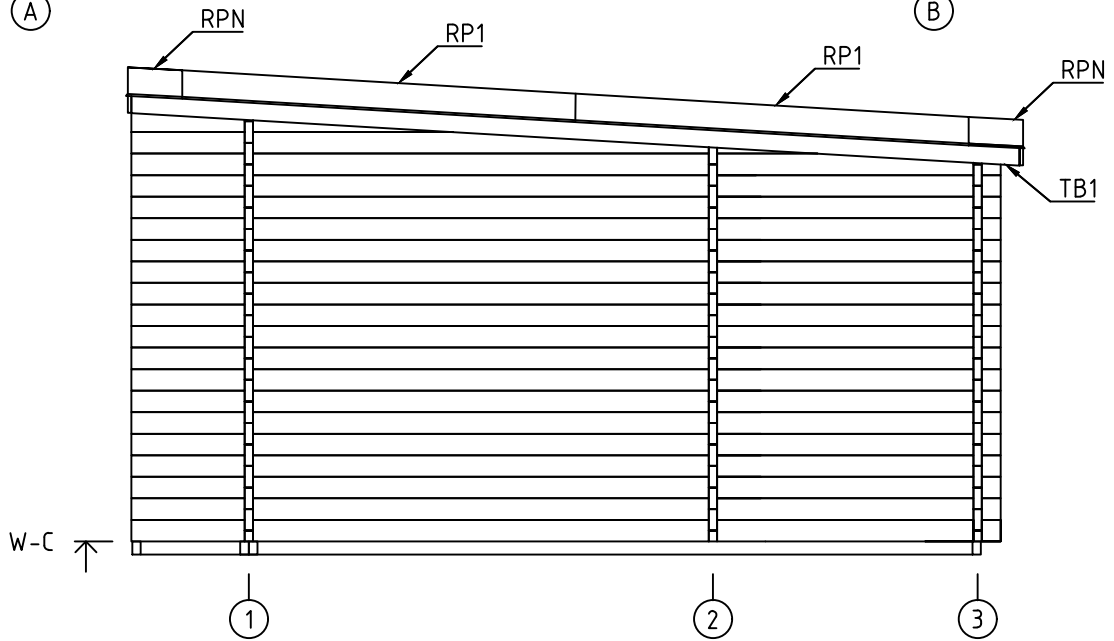
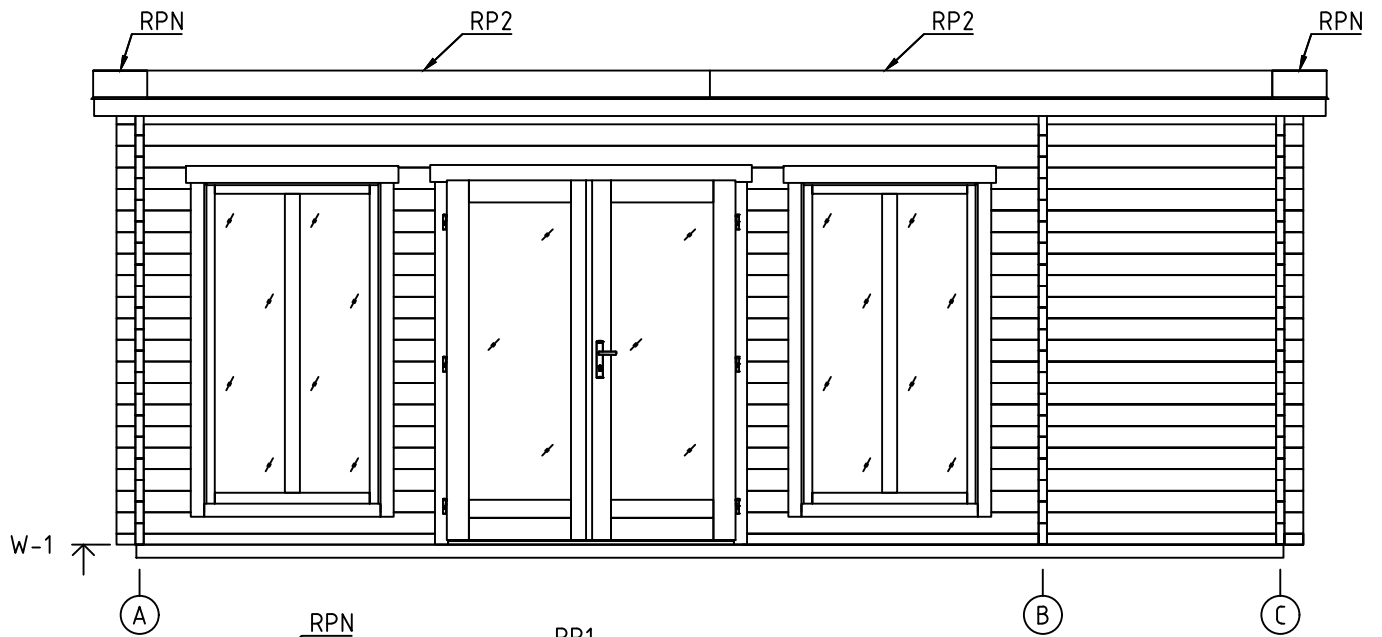



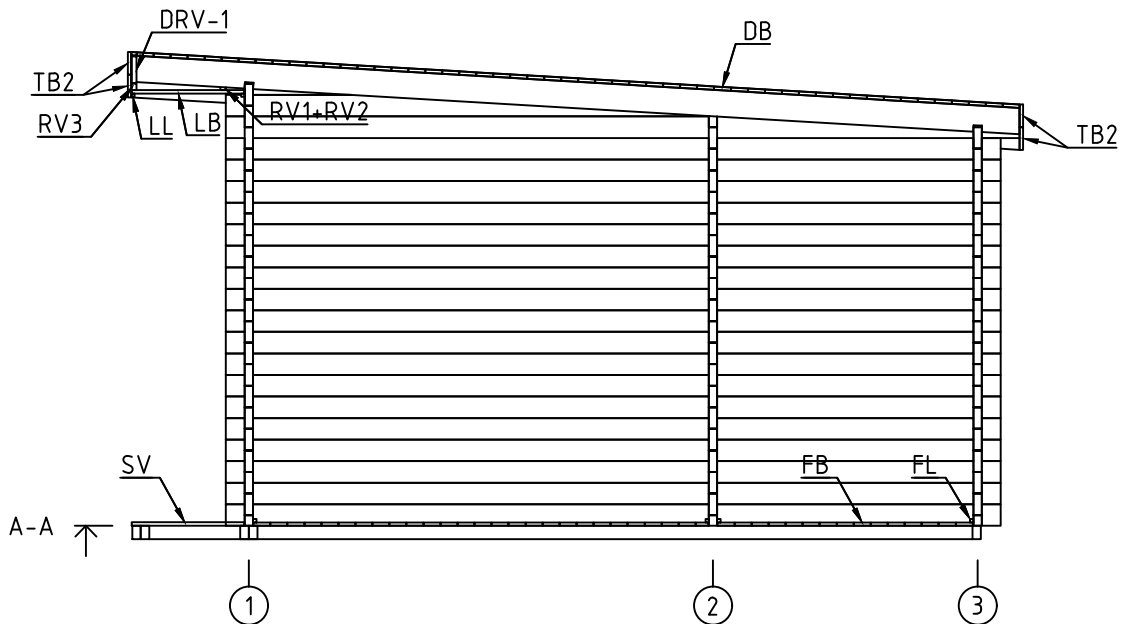



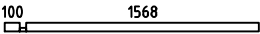
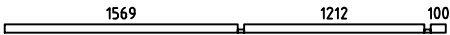
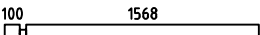
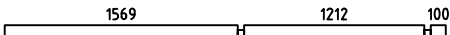

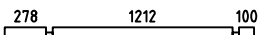
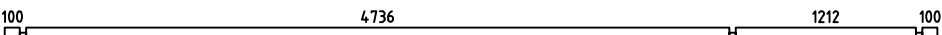
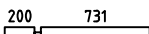
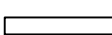

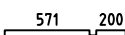
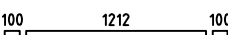
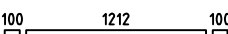
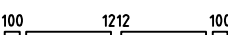
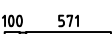
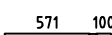



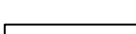
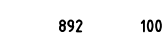



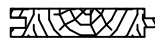



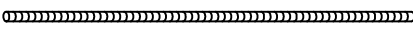
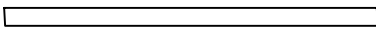
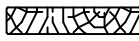

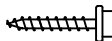

Cross section - Schnitt - Vu de coupe - Sezione trasversale - Doorsnede - Lõige A-A



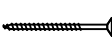

Pos	22.01.2019 Piece list - Stückliste - Liste des pièces - Elementi - Stuklijst - Tükitabel Art. Nr. 4424702	9/12	Q	P (mm)	L (mm)
001			1	44x57	1712
002			1	44x57	2969
003			1	44x114	1712
004			1	44x114	2969
005			16	44x114	420
006			32	44x114	270
007			16	44x114	1678
008			21	44x114	6280
009			2	44x114	975
010			8	44x114	731
011			2	44x114	1346
012			2	44x114	815
013			1	44x57	1500
014			18	44x114	1500
015			1	44x114	1500
016			1	44x83	715
017			1	44x83	715
018			1	44x57	6280
019			1	44x114	4600
020			1	44x114	4600
021			15	44x114	1535
022			15	44x114	892
023			15	44x114	1036

Pos	22.01.2019 Piece list - Stückliste - Liste des pièces - Elementi - Stuklijst - Tükítabel Art. Nr. 4424702	10/12	Q	P (mm)	L (mm)
024			1	44x114	4600
025			1	44x114	4700
029			18	44x114	4100
030			1	44x114	4200
034			1	44x114	4600
035			17	44x114	4600
036			1	44x114	4700
WA-1			1		
WB-1			1		
WC-1			1		
IAR3	Foundation - Fundament - Fondation - Fondamenta - Fundering - Immutatud alusraam 		4	45x70	4797
IAR2	Foundation - Fundament - Fondation - Fondamenta - Fundering - Immutatud alusraam 		14	45x70	3783
IAR4	Foundation - Fundament - Fondation - Fondamenta - Fundering - Immutatud alusraam 		4	45x70	1273
IAR1	Foundation - Fundament - Fondation - Fondamenta - Fundering - Immutatud alusraam 		3	45x70	527
SR1	Rafter - Dachsparren - Chevron - Trave - Dak spar - Sarikas 		6	70x140	4716
RV3	Lath - Pfetten - Liteau - Piccola asse - Gordingen - Roov 		2	28x34	2996
RV1	Lath - Pfetten - Liteau - Piccola asse - Gordingen - Roov 		6	28x34	730
RV2	Lath - Pfetten - Liteau - Piccola asse - Gordingen - Roov 		2	28x34	570
FB	Floor boards - Fussbodenbretter - Lamé de plancher - Pavimento - Vloerhout - Põrandalaud 		43	90x18	4732
FB	Floor boards - Fussbodenbretter - Lamé de plancher - Pavimento - Vloerhout - Põrandalaud 		43	90x18	1208
SV	Terrace boards - Terrassenbretter - Plancher de terrasse - Piattaforme terrazzo - Terrasvloer - Terrasilaud 		64	90x19	596
DB	Roof boards - Dachbretter - Voliges - Perlina per tetto - Dakhout - Katuselaud 		53	90x18	3413
DB	Roof boards - Dachbretter - Voliges - Perlina per tetto - Dakhout - Katuselaud 		53	90x18	3067

Pos	Piece list - Stückliste - Liste des pièces - Elementi - Stuklijst - Tükitalabel 22.01.2019 Art. Nr. 4424702 11/12	Q	P (mm)	L (mm)
LB	Ceiling boards - Deckenbrett - Voliges sous plafond - Tavole per piano soffitto - Dakhout - Laelaud 	67	90x18	596
LL	Ceiling fillet - Deckeleiste - Profil de finition sous plafond - Massello per soffitto - Dak afdekljst - Laeliist 		18x18	13.17
FL	Floor fillet - Fussbodenteiste - Corniere de finition du plancher - Finitura per pavimento (battisco pa) - Vloerafwerkljst - Pörandaliist 		18x18	29.43
M1	Treaded rod m10 - Gewindestange m10 - Tige filetée m10 - Barra filettata passo m10 - Draadstang 10m - Keermelatt 	2		250
M2	Treaded rod m10 - Gewindestange m10 - Tige filetée m10 - Barra filettata passo m10 - Draadstang 10m - Keermelatt 	2		450
M3	Treaded rod m10 - Gewindestange m10 - Tige filetée m10 - Barra filettata passo m10 - Draadstang 10m - Keermelatt 	4		2000
TB1	Fascia board - Traufbrett - Bandeau de toit - Finitura lati tetto - Gevelljst - Räästalaud 	4	18x120	4715
TB2	Fascia board - Traufbrett - Bandeau de toit - Finitura lati tetto - Gevelljst - Räästalaud 	8	18x120	3258
RP1	Fascia sheet - Abschlussprofil - Profil de finition métallique pour débord de toiture - Scossalina di protezione dall'acqua per bordo di legno - Afdek profil / boordprofiel - Räästaplekk 	4		2200
RP2	Fascia sheet - Abschlussprofil - Profil de finition métallique pour débord de toiture - Scossalina di protezione dall'acqua per bordo di legno - Afdek profil / boordprofiel - Räästaplekk 	4		3100
DRV-1	Roof edge reinforcement - Dachrandverstärkung - Corniere de renfort de bord de toit - Rinforzo x tetto - Dakrand versterking - Räästatugevdus 	2	28x34	140
LD1	Lid for treaded rod hole - Abdeckung für gewindestangenöffnung - Couvercle pour acces réglagé tige filetée - Copeerchio per foro barra filettata - Afdekprofiel voor draadstang - Kaas keermelati avale 	2		
	Screw for fascia sheet - Schraube für abschlussprofil - Vis pour profil de finition métallique pour débord de toiture - Viti per fissare i folgi di gronda - Schroef voor afsluit (afdek)profiel - Katusekruvi 	56	4.8x28	
	Lengthening bolt for treaded rod - Verlängerungsmutter für gewindestange - Manchon de raccordement de tige filetée - Bullone per barra filettata passo - Extensie moer voor draadstang - Keermelati jätkumutter 	4	D10	
HS12	Screw for roof lath - Schraube für dachlatte - Vis pour latte - Vite per listello del tetto - Schroef voor daklat - Kruvi roovile	30	4x40	
HS12	Screw for fascia boards - Schrauben für traufbretter - Vis pour fixation bandeau de toit - Viti x striscia del tetto - Schroef voor gevelljst - Kruvi räästalauale 	100	4x40	
HS12	Screw for roof edge reinforcement - Schrauben für dachrandverstärkung - Vis pour fixation corniere renfort de bord de toit - Viti x rinforzo bordo tetto - Schroef voor dakrand versterking - Kruvi räästatugevdusele 	4	4x40	
HS18	Screw for gable - Schrauben für giebel - Vis pour fixation des pignons - Viti per timpano - Schroef voor gevelpunt - Kruvi kelba kinnitamiseks 	18	5x120	
HS18	Screw for roof beams - Schrauben für dachbalken - Vis pour fixation pannes de toit - Viti per perline del tetto - Schroef voor gordingen / dakbalken - Kruvi pärlinitele 	13	5x120	
HS18	Screw for gable - Schrauben für giebel - Vis pour fixation des pignons - Viti per timpano - Schroef voor gevelpunt - Kruvi viilude kinnitamiseks 	8	5x120	
HS16	Screw for 1. wall beam - Schraube für 1. bohlenreihe - Vis de fixations 1ere rangée de madriers avec poutrelles de fondations - Vite fissaggio alle fondamenta - Schroef voor 1 wandbalk - Kruvi poollauale 	12	5x90	
HS16	Screw for foundation - Schrauben zur befestigung fundament - Vis de fixations des poutrelles de fondations - Viti x fondamenta - Schroef voor fundering - Kruvi alusraamile 	54	5x90	
HS23	Screw for wall details - Schraube für wand details - Vis pour mur details - Viti per elementi della porta - Schroef voor wand details - Kruvi seinadetailidele 	30	6x180	



Pos	10.11.2017	Piece list - Stückliste - Liste des pièces - Elementi - Stuklijst - Tükítabel 560x1780 AK.1.100.TPSP DGP+	1/1	Q	P (mm)	L (mm)
-----	------------	--	-----	---	-----------	-----------

Glass size - Glasgröße - Taille de la vitre - Misura del vetro - Glas afmeting - Klaasi mõõt: 390x1602 mm

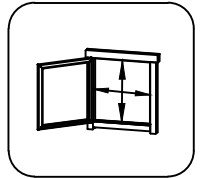
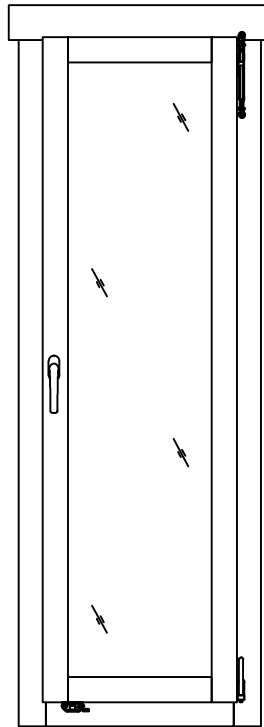







460x1684 mm

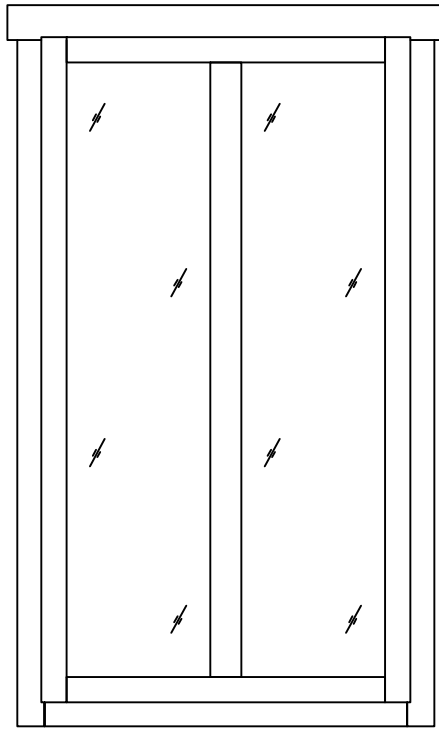

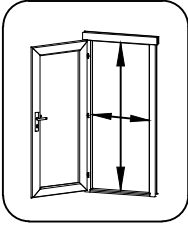
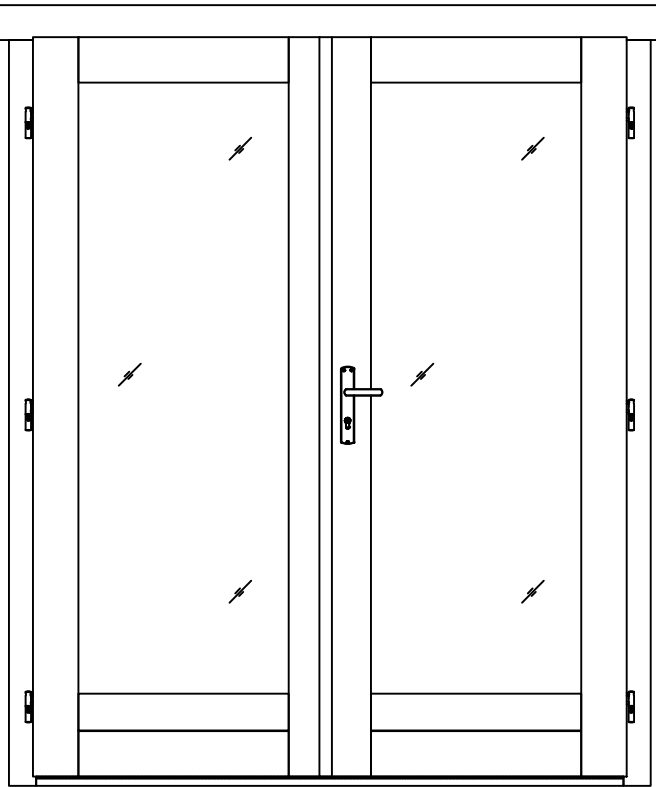
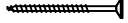
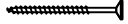
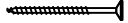

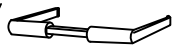

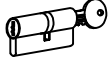
FS2	Window handle fittings - Fenstergriff - Poignee de fenetre - Maniglia c/ferramenta - Raamhendel -/grendel -/klink - Aknalink		1		
-----	---	---	---	--	--

Pos	10.11.2017	Piece list - Stückliste - Liste des pièces - Elementi - Stuklijst - Tükítabel 1010x1780 TAK.1.100.TPM0.e DGP+	1/1	Q	P (mm)	L (mm)
-----	------------	--	-----	---	-----------	-----------

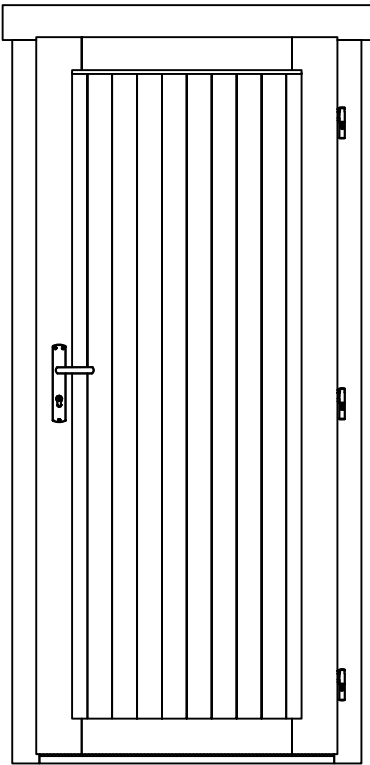
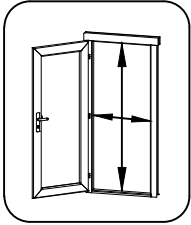
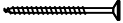
Glass size - Glasgröße - Taille de la vitre - Misura del vetro - Glas afmeting - Klaasi mõõt: 390x1602 mm

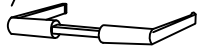

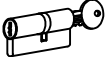
Pos	31.10.2017	Piece list - Stückliste - Liste des pièces - Elementi - Stuklijst - Tükítabel 1588x1957 TUK.1.100.TPVP.MM DGP+	1/1	Q	P (mm)	L (mm)
Glass size - Glasgröße - Taille de la vitre - Misura del vetro - Glas afmeting - Klaasi mõõt: 561x1593 mm					 1488x1873 mm	
						
HS4	Screw for door fillet - Schraube zur Befestigung türleiste - Vis pour fixation baguette d'arret de porte - Viti per massellino della porta - Schroef voor deurlijst - Kruvi ukse kokkuvaltšiliistule				5	3x30
HS16	Screw for door jamb - Schraube für Türrahmen - Vis de fixation partie haute avec montants du cadre de porte - Viti x fissaggio montanti porte - Schroef voor deurkozijn - Kruvi ukse lengile				4	5x90
HS25	Screw for doorstep - Schrauben für swelle - Vis pour fixation barre de seuil - Vite per soglia della porta - Schroef voor deurdorpel - Kruvi lävepakule				3	4.5x65
MH	Male bolt hinge for door - Türband - Partie male de paumelle de porte - Cerniera anube x porta - Scharnier bout - Reguleeritav polthing isane				6	14x80
HC	Covers for door hinges - Schutzkappe für Türband - Couverture de paumelle de porte - Copertura delle cerniere della porta - Afdek kap voor deurscharnier - Reguleeritava polthinge kate				12	
TL4	Door handle fittings - Türgriff - Poignée de porte - Maniglie - Deurhendel / klink - Ukse käepide				1	
TL5	Set of door lock covers - Schlossblenden - Set de garnitures de porte - Copertura serrature - Slot sluitplaat set - Ukse lukuplaat				1	
	Cylinder lock - Zylinderschloss - Barillet de porte - Serratura - Cylinder slot - Ukse lukusüdamik				1	30x35
	Striker for barrel bolt - Hülse für Grendelriegel - Gache au sol du targette - Boccola per fermo della porta - Huls voor vergrendelingsschuif - Vasturaud ukse servariivile				2	

Pos	12.05.2016	Piece list - Stückliste - Liste des pièces - Elementi - Stuklijst - Tükítabel 835x1900 UL.2.100.IVP.MMWd TP+	1/1	Q	P (mm)	L (mm)
		  <p>735x1818 mm</p>				
HS16	Screw for door jamb - Schraube für Türrahmen - Vis de fixation partie haute avec montants du cadre de porte - Viti x fissaggio montanti porte - Schroef voor deurkozijn - Kruvi ukse lengile		4	5x90		
HS25	Screw for doorstep - Schrauben für swelle - Vis pour fixation barre de seuil - Vite per soglia della porta - Schroef voor deurdorpel - Kruvi lävepakule		2	4.5x65		
TL4	Door handle fittings - Türgriff - Poignée de porte - Maniglie - Deurhendel / klink - Ukse käepide VU		1			
TL5	Set of door lock covers - Schlossblenden - Set de garnitures de porte - Copertura serrature - Slot sluitplaat set - Ukse lukuplaat		1			
	Cylinder lock - Zylinderschloss - Barillet de porte - Serratura - Cylinder slot - Ukse lukusüdamik		1	30x35		
	Male bolt hinge for door - Türband - Partie male de paumelle de porte - Cerniera anube x porta - Scharnier bout - Ukse polthing isane		3			
HC	Covers for door hinges - Schutzkappe für Türband - Couverture de paumelle de porte - Copertura delle cerniere della porta - Afdek kap voor deurscharnier - Reguleeritava polthinge kate		6			