

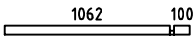

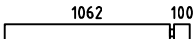

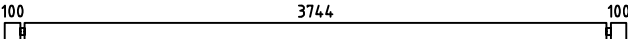





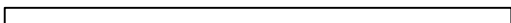
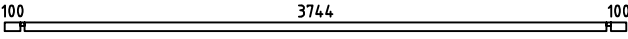
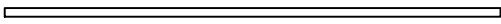
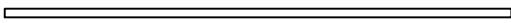
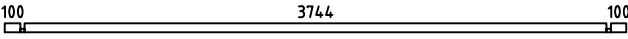
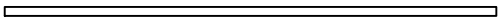

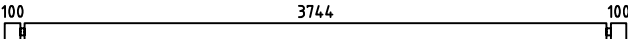
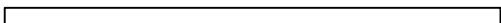
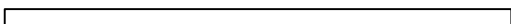
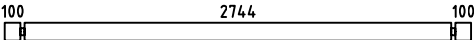
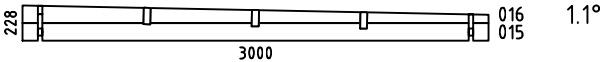
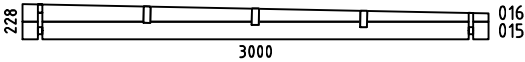
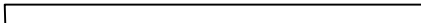

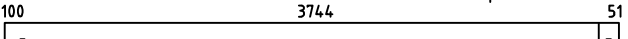
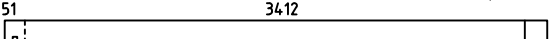
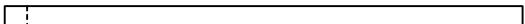

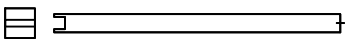

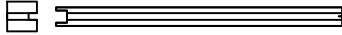
Dave28

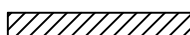
Pos	Specification-Spezifikation-Specificatie	St.	Profile (mm)	Length (mm)
001		2	28x57	1190
002		32	28x114	1190
003		19	28x114	4000
004		1	28x114	3190
005		1	28x114	3260
006		1	28x55	4000
007		1	28x55	3190
008		1	28x55	3260
009		1	28x57	4000
010		2	28x57	3162
011		34	28x114	3162
012		1	28x114	4000
013		1	28x114	3190
014		1	28x114	3260
015		34	28x114	3000
WA-1		1		
WB-1		1		
SR1	RAFTER-DACHSPARREN-DAKSPAR 	2	44x14.4	2688
CS1	CORNICE SUPPORT-TRAGELEISTE FÜR GESIMSE-KROONLIJST STEUNEN BAR 	12	44x70	100
PR1	Purlin-Dakbalk-Dachpfette 	3	44x14.4	3951
PR2	Purlin-Dakbalk-Dachpfette 	3	44x14.4	3491
PR3	Purlin-Dakbalk-Dachpfette 	3	44x14.4	3332
DP-1	Roof board-Dachbrett-Dakplank 	120	88x18	3000
P-1	-POST 85x85 	2		2415
P-2	-POST 85x85-H 	1		2360
Kood	Materjal	File	Dave28.dwg	Leht 1/2

Pos	Specification-Spezifikation-Specificatie	St.	Profile (mm)	Length (mm)
P-3	-POST 85x85-U 	1		2360
L-1	Eave Board-Traufenblende-Afdekplank 	2	18x120	3050
L-2	Eave Board-Traufenblende-Afdekplank 	2	18x120	3280
L-3	Eave Board-Traufenblende-Afdekplank 	2	18x120	3355
L-4	Eave Board-Traufenblende-Afdekplank 	2	18x120	3905
H-1	H-Profile 	1		170
H-2	H-Profile 	1		2065
	Adjustable foot-Stellfuß+Schrauben 4x50 4stück für Post 	4		
	Double Door Set-Doppeltür Satz-Dubbele Deur Set  3x25 x2 4x60 x4	1		
HS1	Wood Bolt set-Holzschraubesatz-Hout Bout 8x160 	8		
DD4B 1 60x185	DOOR 1600x1850 	1		
Kood	Materjal	File	Dave28.dwg	Leht 2/2

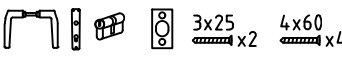
H = 1.700 m
 TOTAL: 10.27 m²

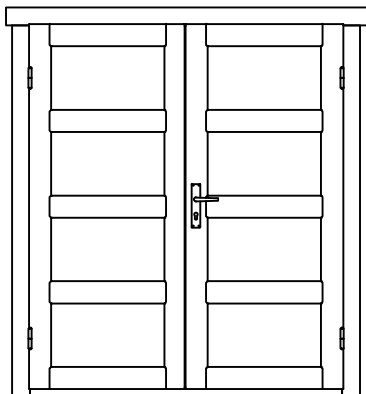
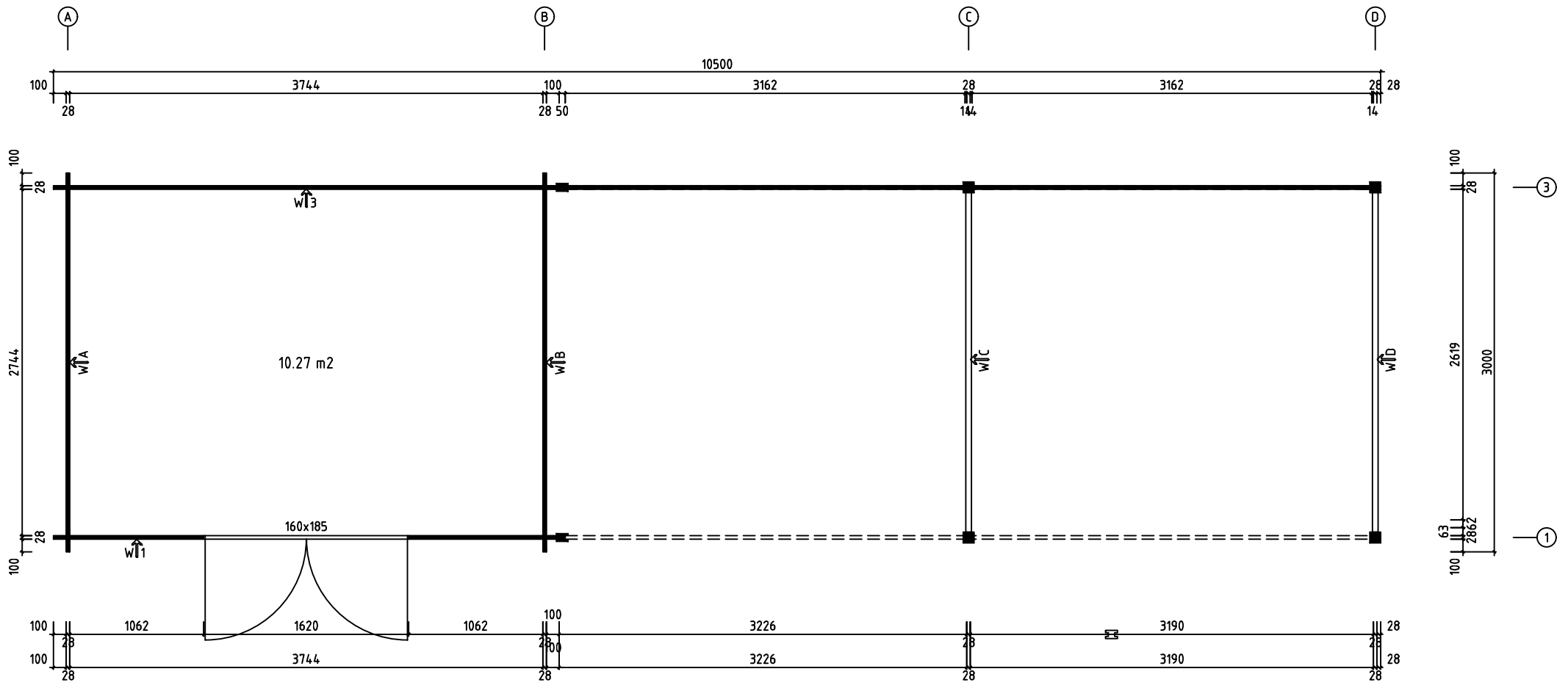

Model	Dave28	Page	PLAN
Client		Scale	1:30
Material	28x114 mm	Date	22.01.2019
Company	File Dave28.dwg		

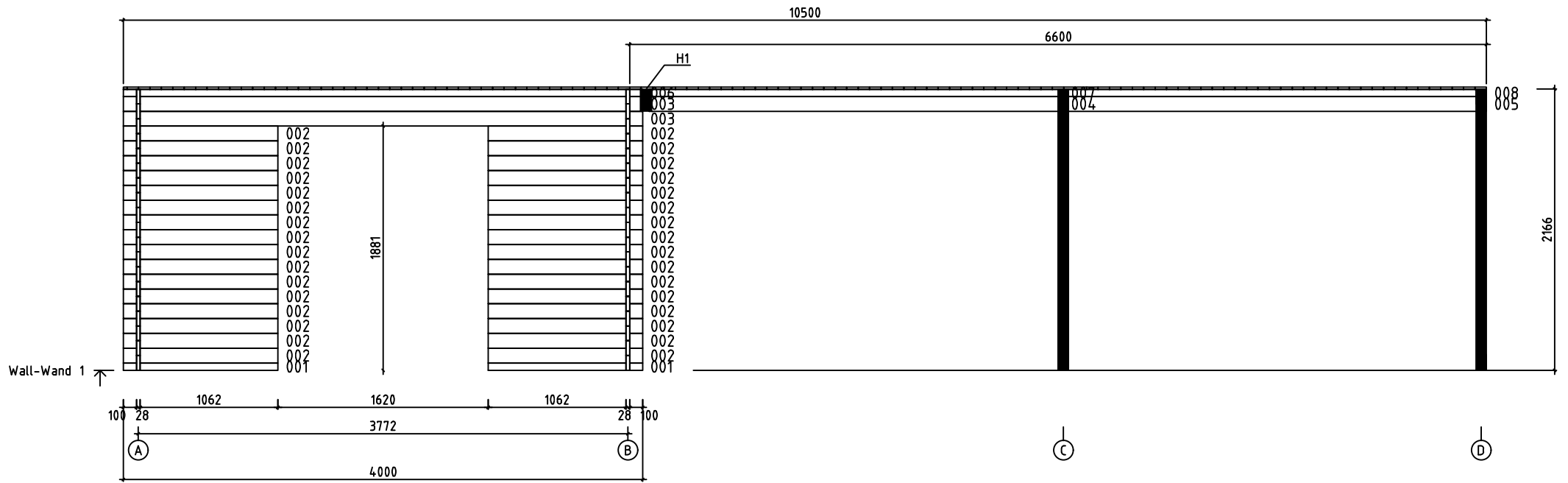

Model	Dave28	Page	6
Client		Scale	1:30
Material	2.8x11.4	Date	22.01.2019
Company		File	Dave28.dwg

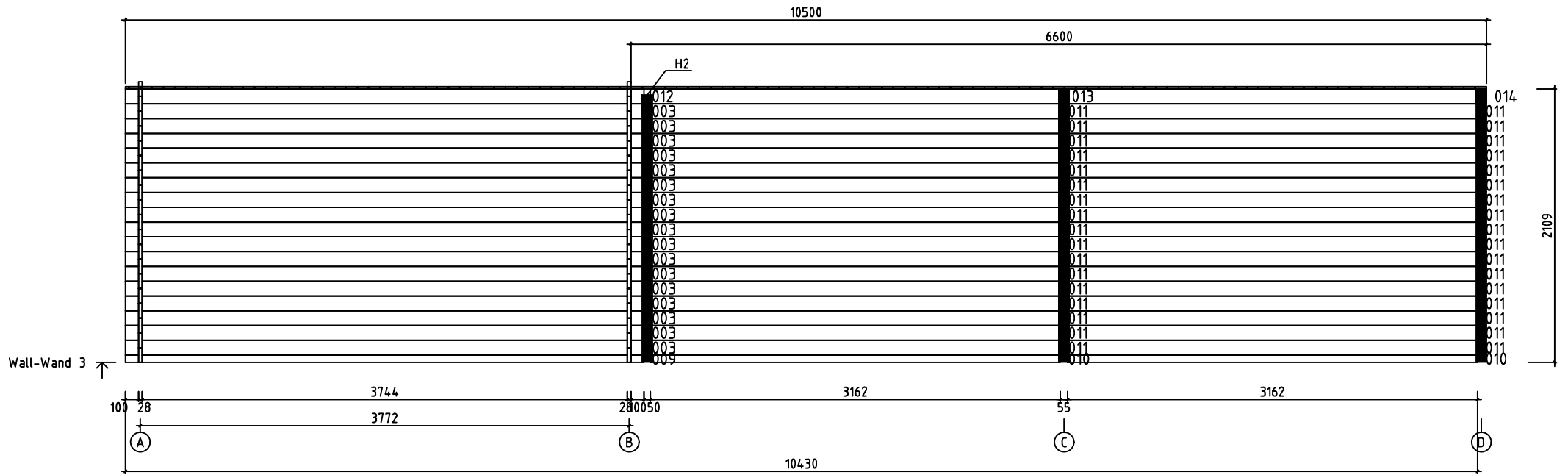

Model	Dave28	Page	7
Client		Scale	1:30
Material	2.8x11.4	Date	22.01.2019
Company		File	Dave28.dwg

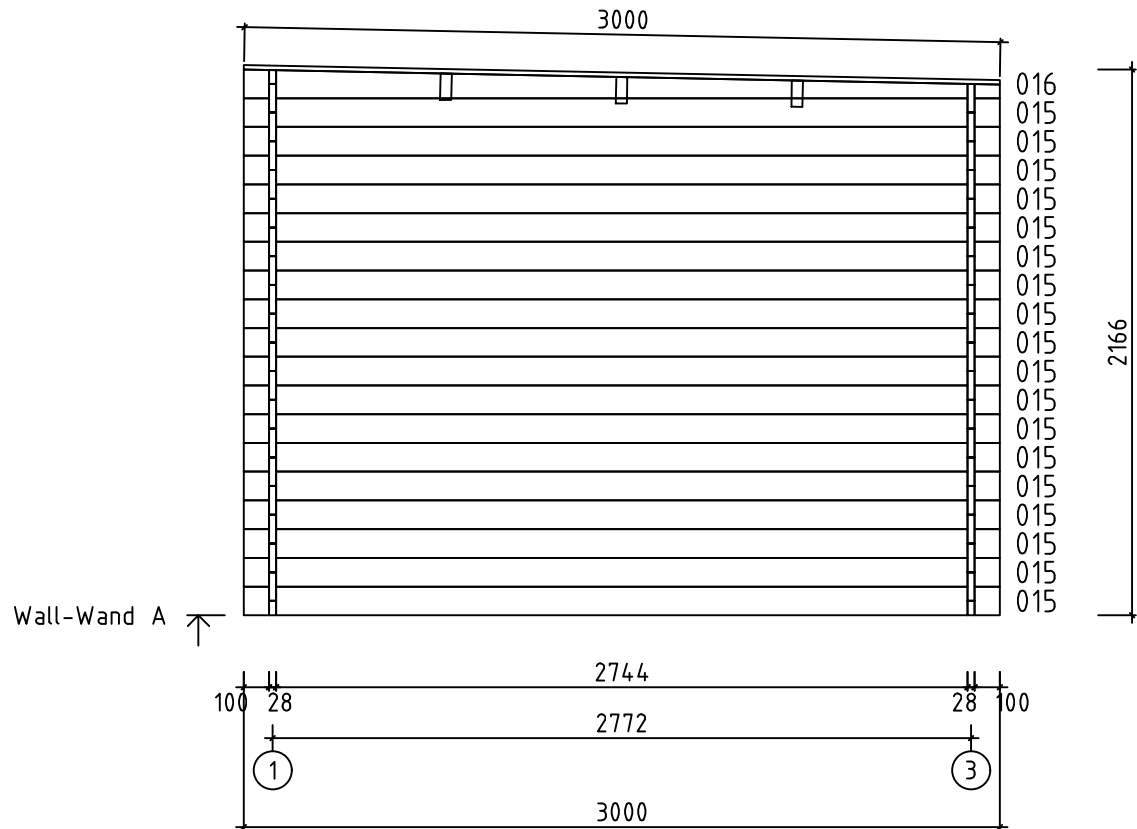

Model	Dave28	Page	2
Client		Scale	1:30
Material	2.8x11.4	Date	22.01.2019
Company		File	Dave28.dwg

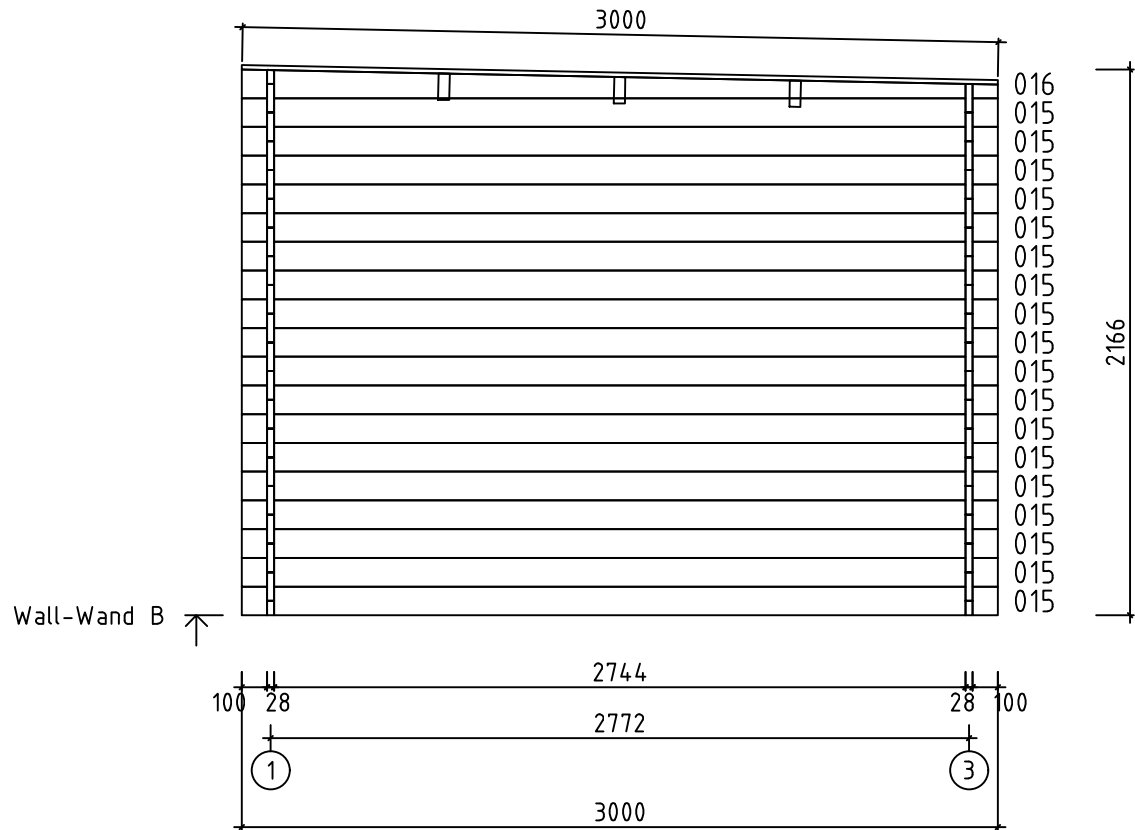

Model	Dave28	Page	3
Client		Scale	1:30
Material	2.8x11.4	Date	22.01.2019
Company		File	Dave28.dwg

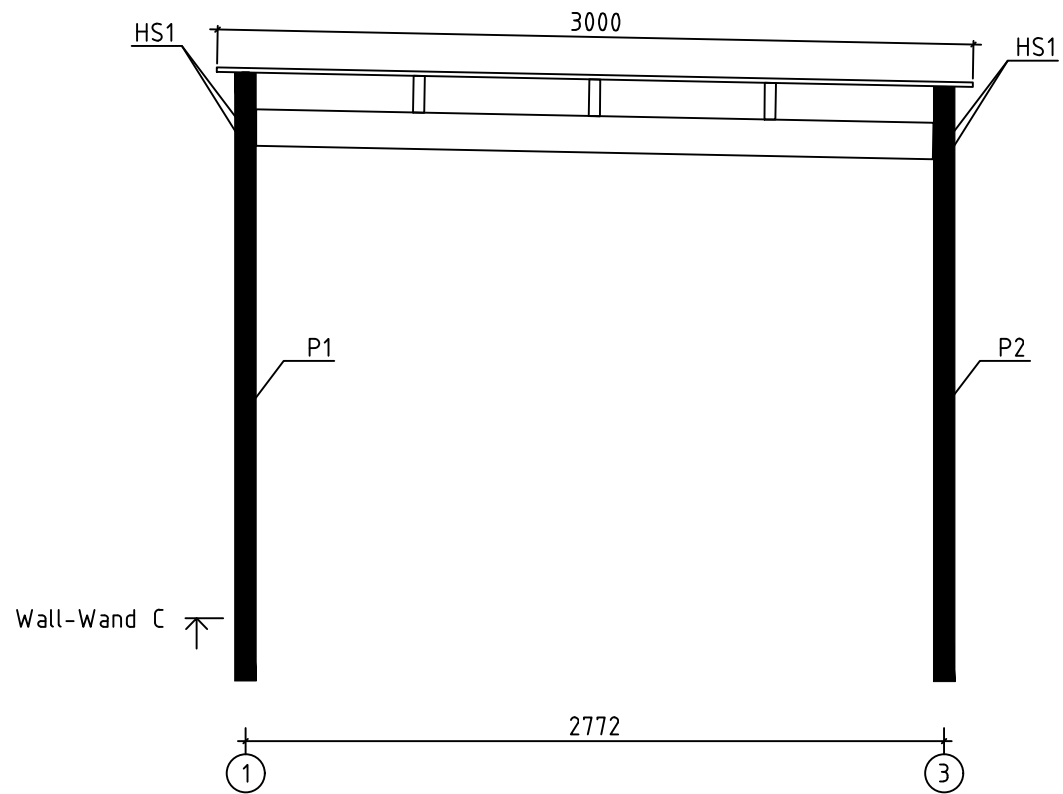

Model	Dave28	Page	4
Client		Scale	1:30
Material	2.8x11.4	Date	22.01.2019
Company		File	Dave28.dwg

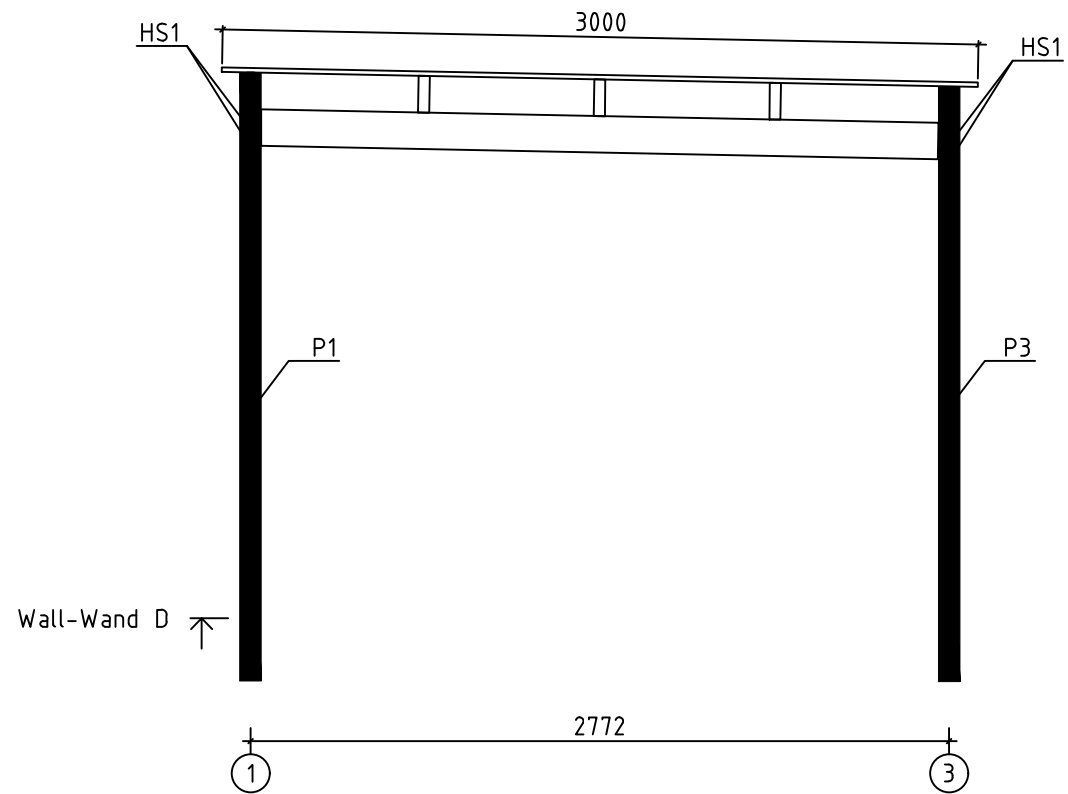

Model	Dave28	Page	5
Client		Scale	1:30
Material	2.8x11.4	Date	22.01.2019
Company		File	Dave28.dwg

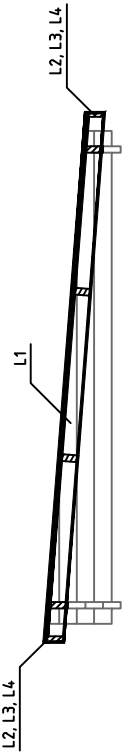
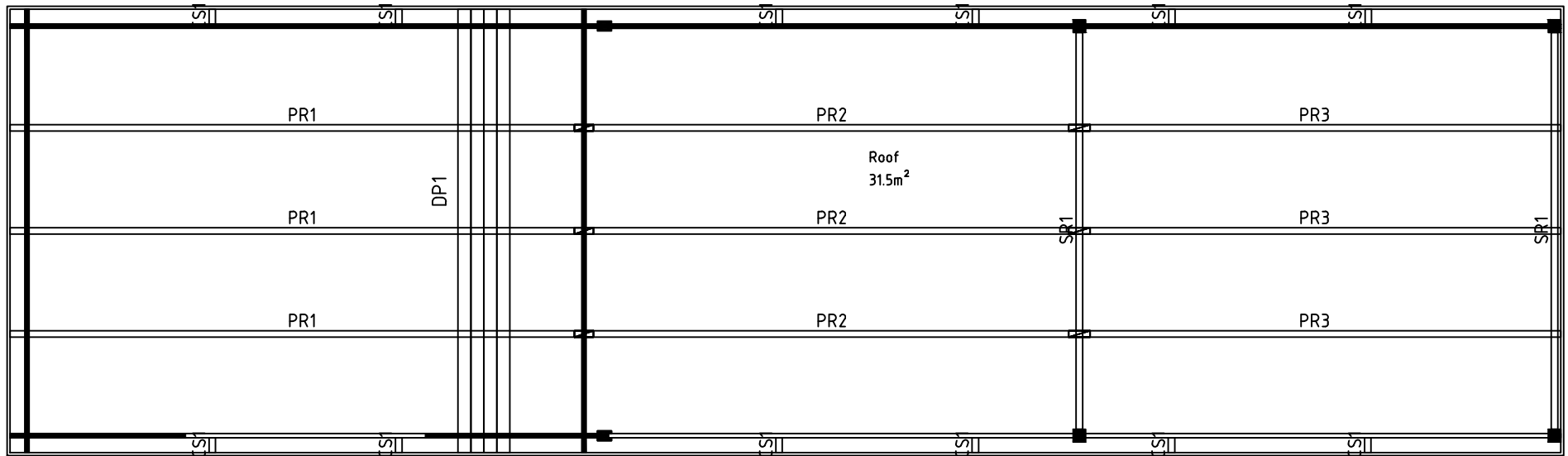

Model	Dave28	Page	ROOF
Client		Scale	1:30
Material	28x114mm	Date	22.01.2019
Company		File	Dave28.dwg

The guide is illustrative. This guide is not project specification.
 Der Leitfaden ist illustrativ. Dieser Leitfaden ist keine Projektspezifikation.
 De gids is illustratief. Deze gids is geen projectspecificatie.

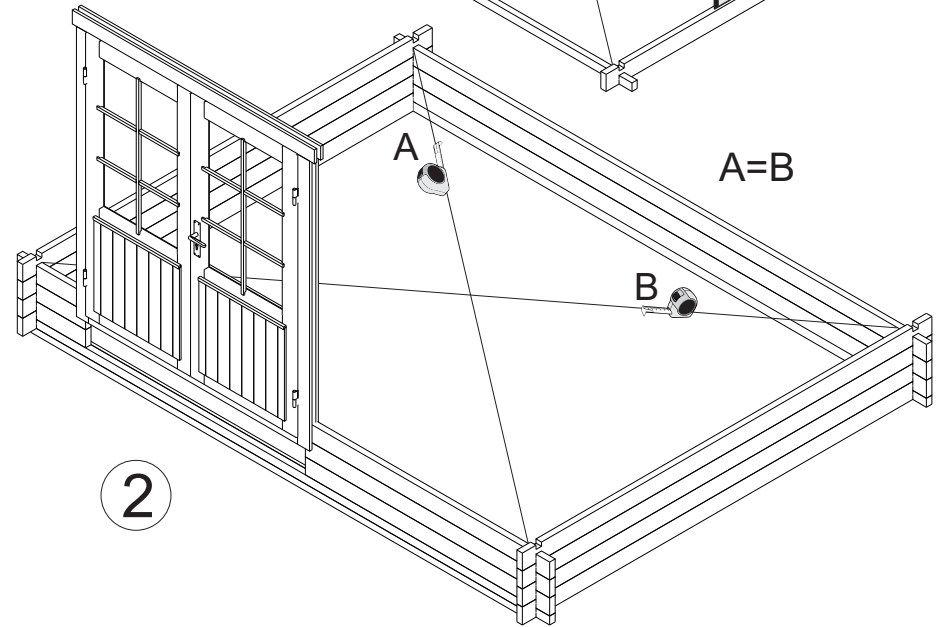
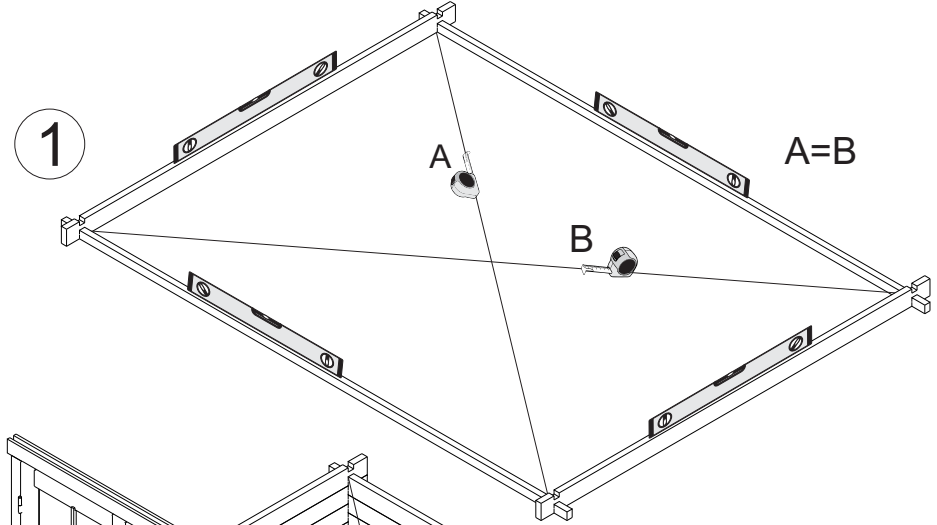
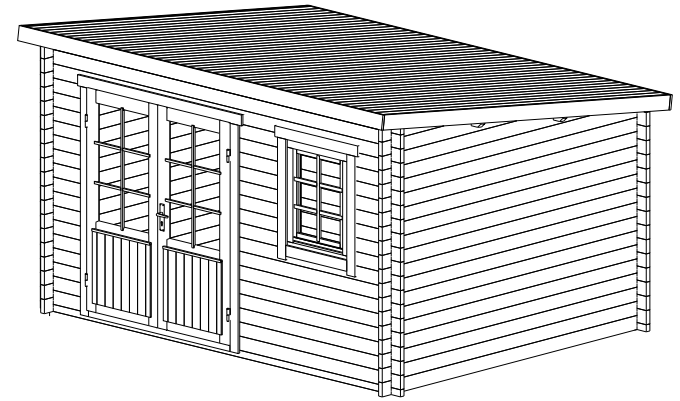
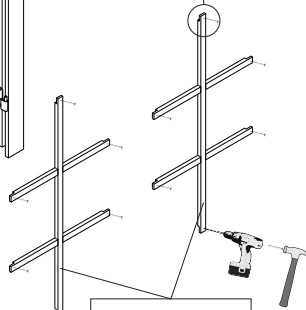
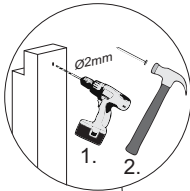
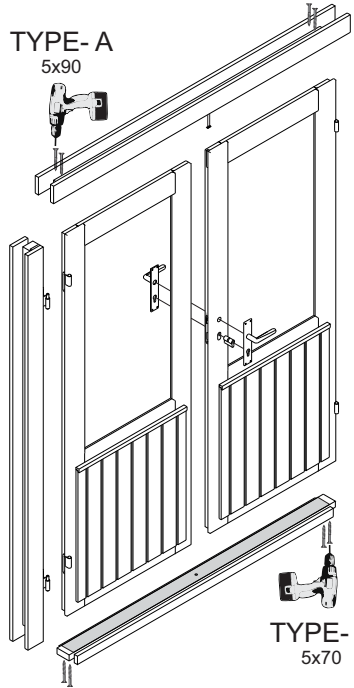
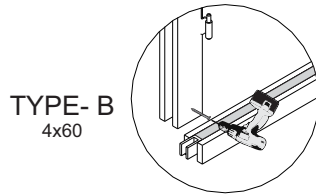
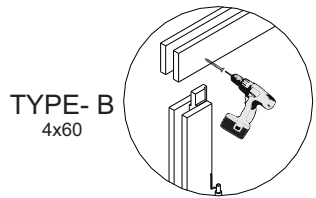
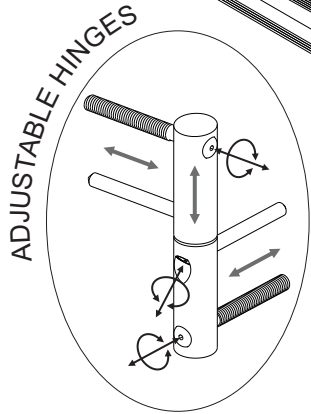
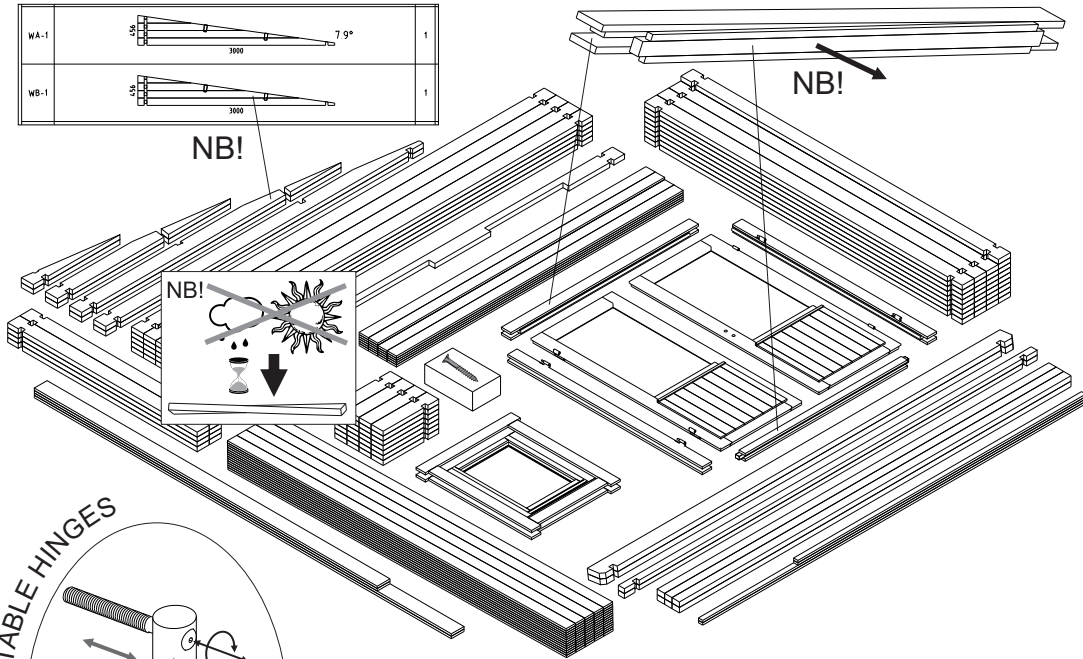
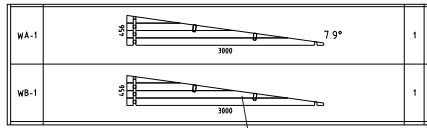

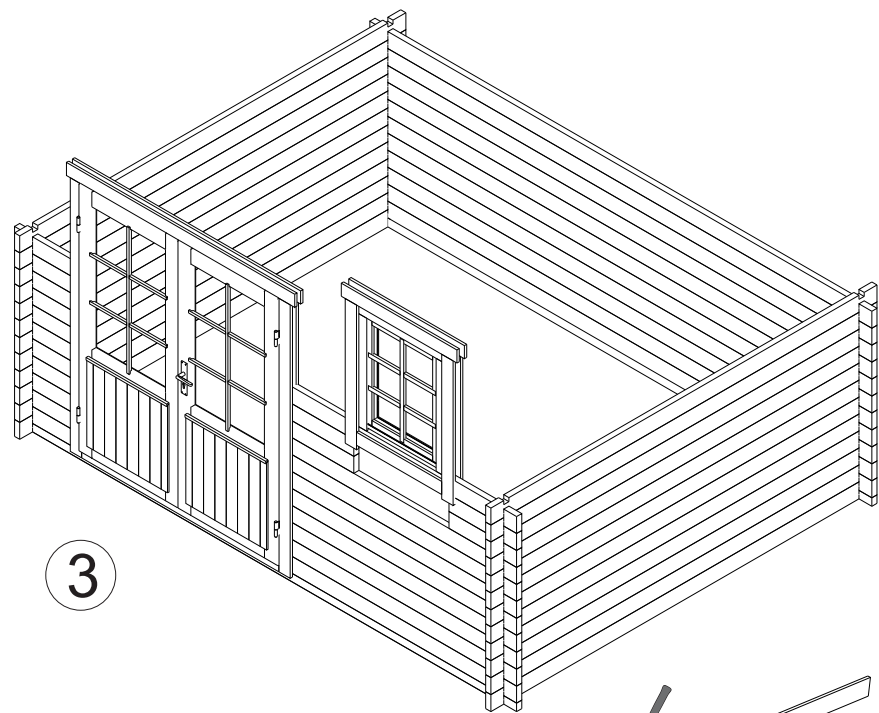

4

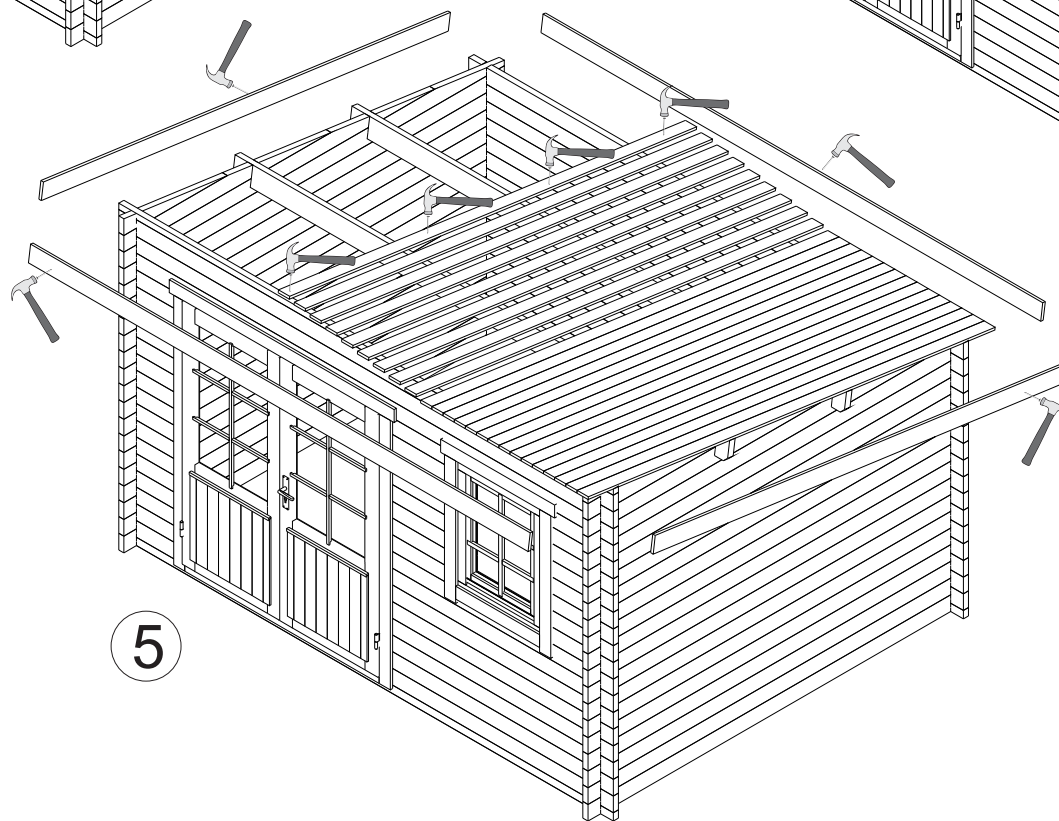
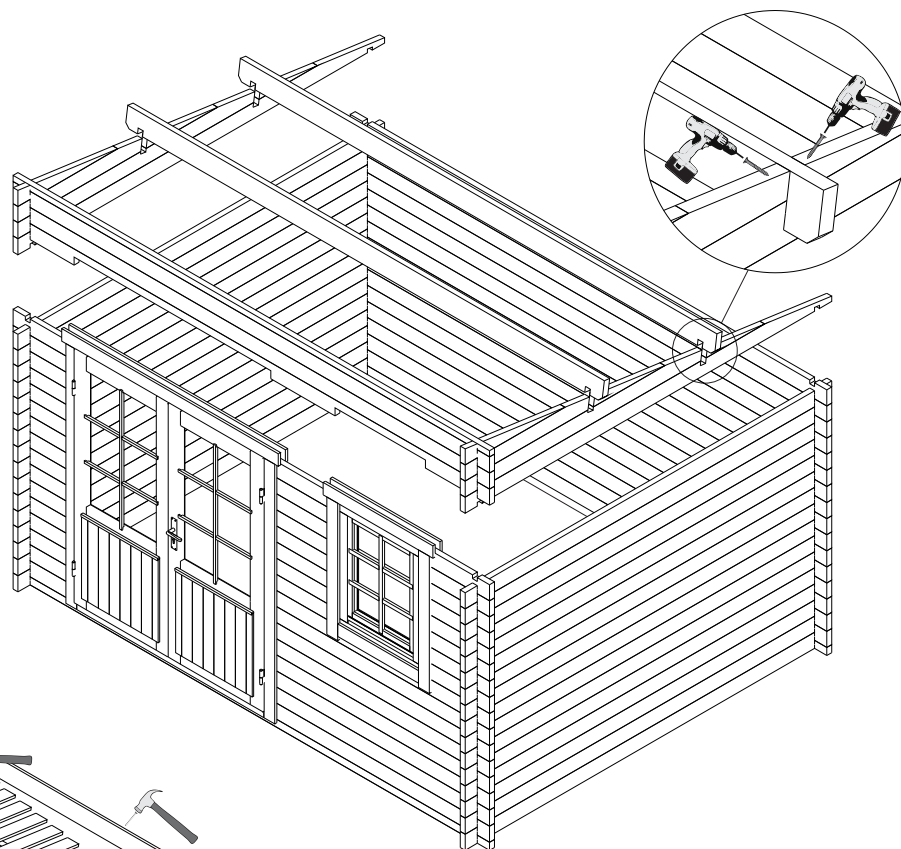

Cutting support post / Schneiden der Stützpfeiler

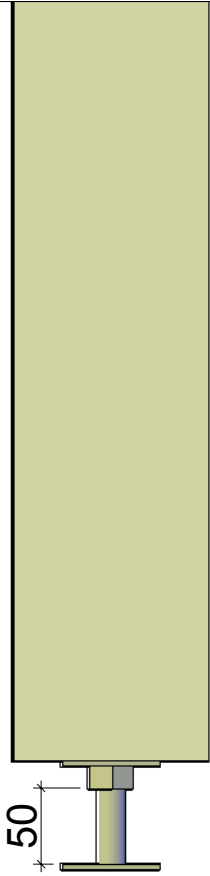

- * Adjustment space for post support should be at least 50mm.
- * Einstellraum für die Pfostenstütze muss mindestens 50mm sein.

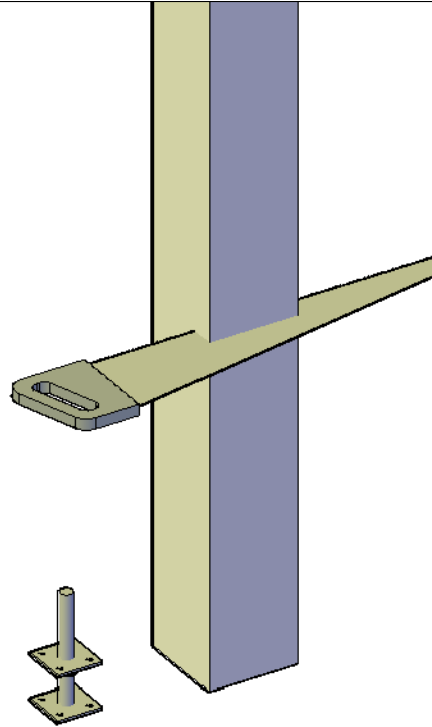

- * Support post has extra length for various conditions. Must be sawn to suitable length on spot considering local conditions.
- * Stützpfeiler hat extra Länge für verschiedene Bedingungen. Muss vor Ort unter Berücksichtigung der örtlichen Gegebenheiten zu einer geeigneten Länge gesägt werden.

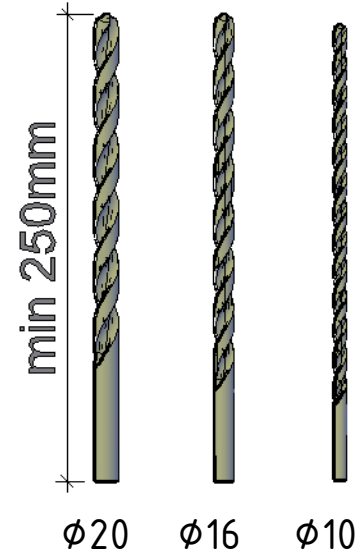
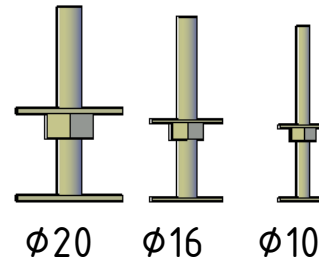

- * In some cases you need to drill a new hole for a post support. Find a matching drill bit.
- * In einigen Fällen müssen Sie ein neues Loch für die Pfostenstütze bohren. Finden Sie hier den passenden Bohrer.

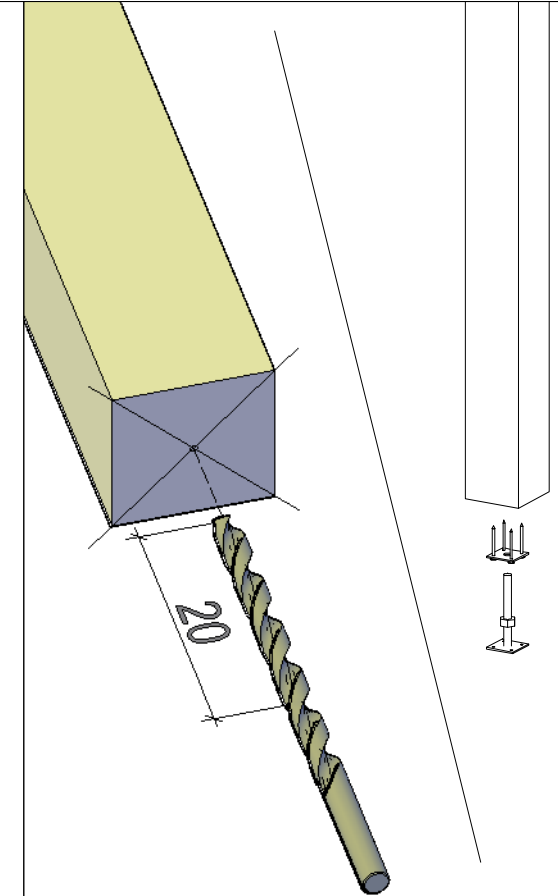

- * Mark the center of the post and drill a new 20cm deep hole. Continue building.
- * Markieren Sie die Mitte des Pfeilers und bohren Sie ein neues 20cm tiefes Loch. Danach mit Aufbau weiter machen.