

H = 1.500 m
TOTAL: 14.62 m²

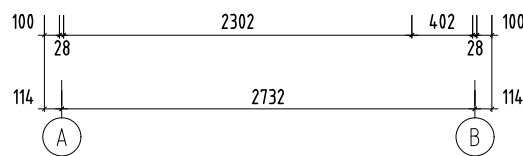

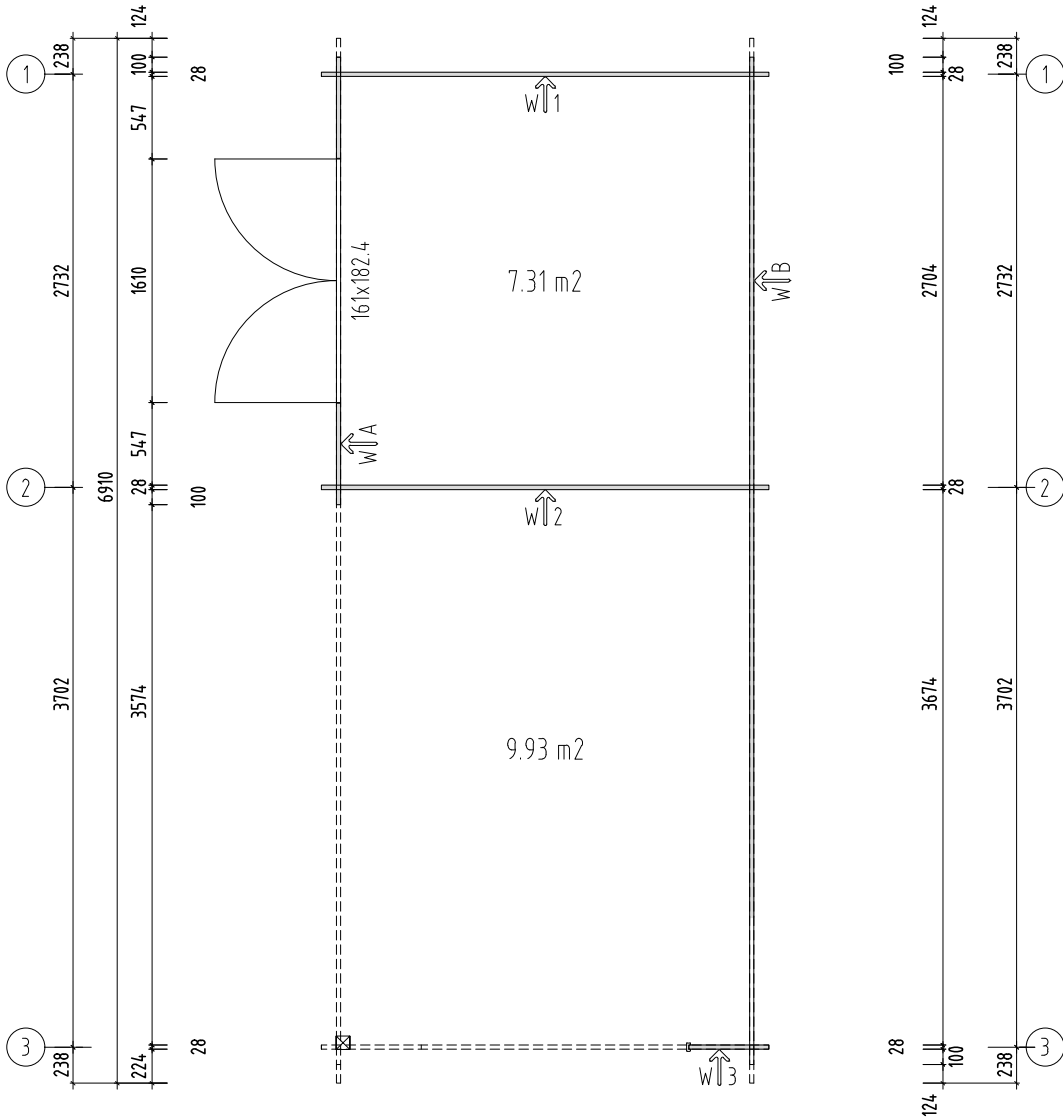

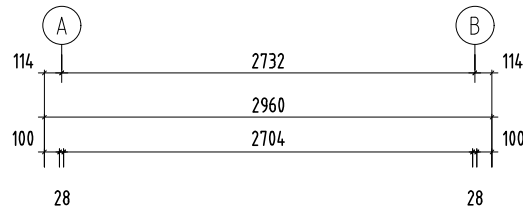

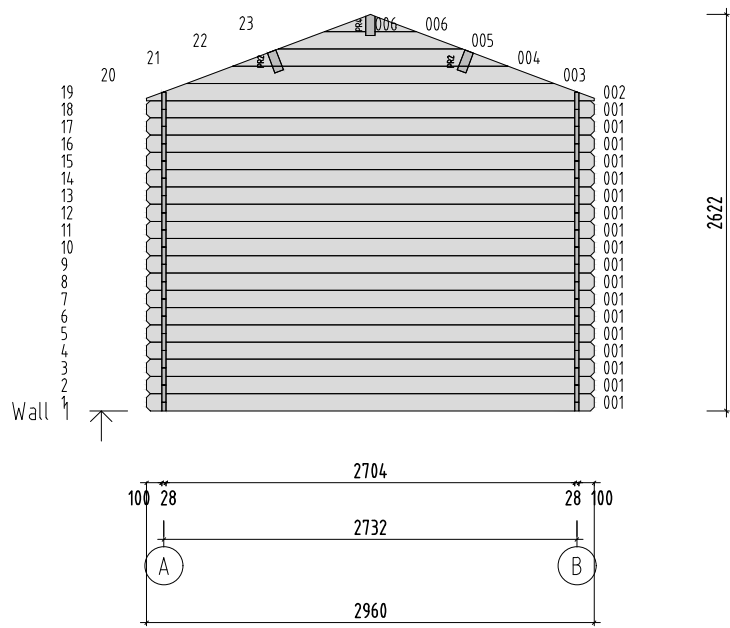
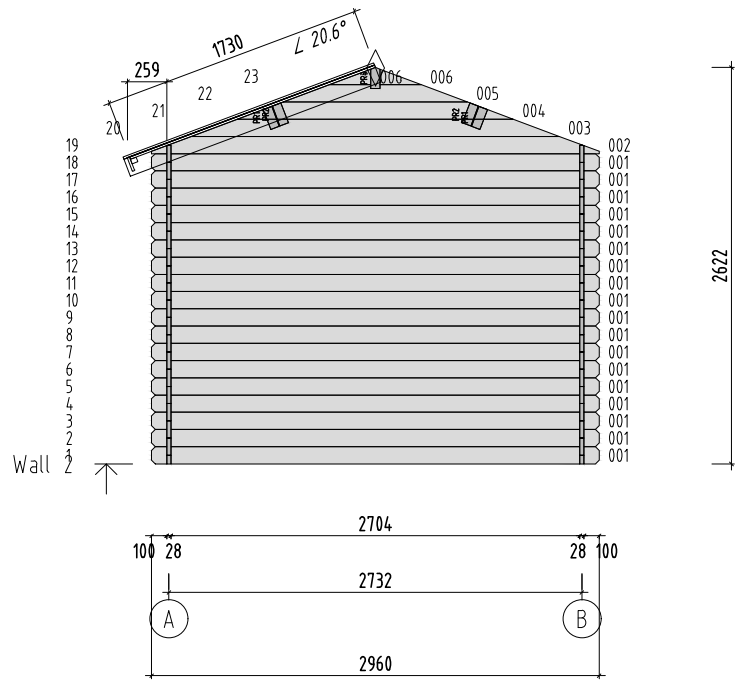
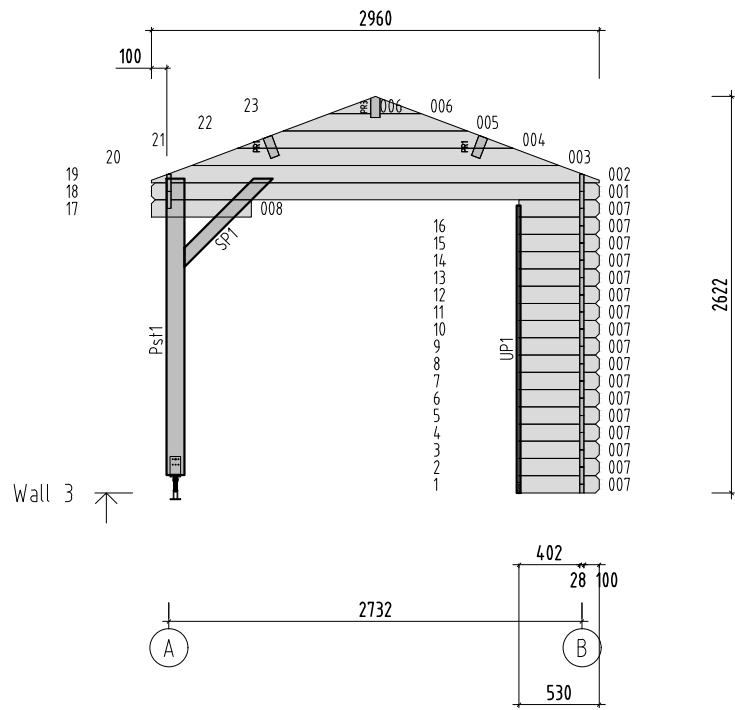

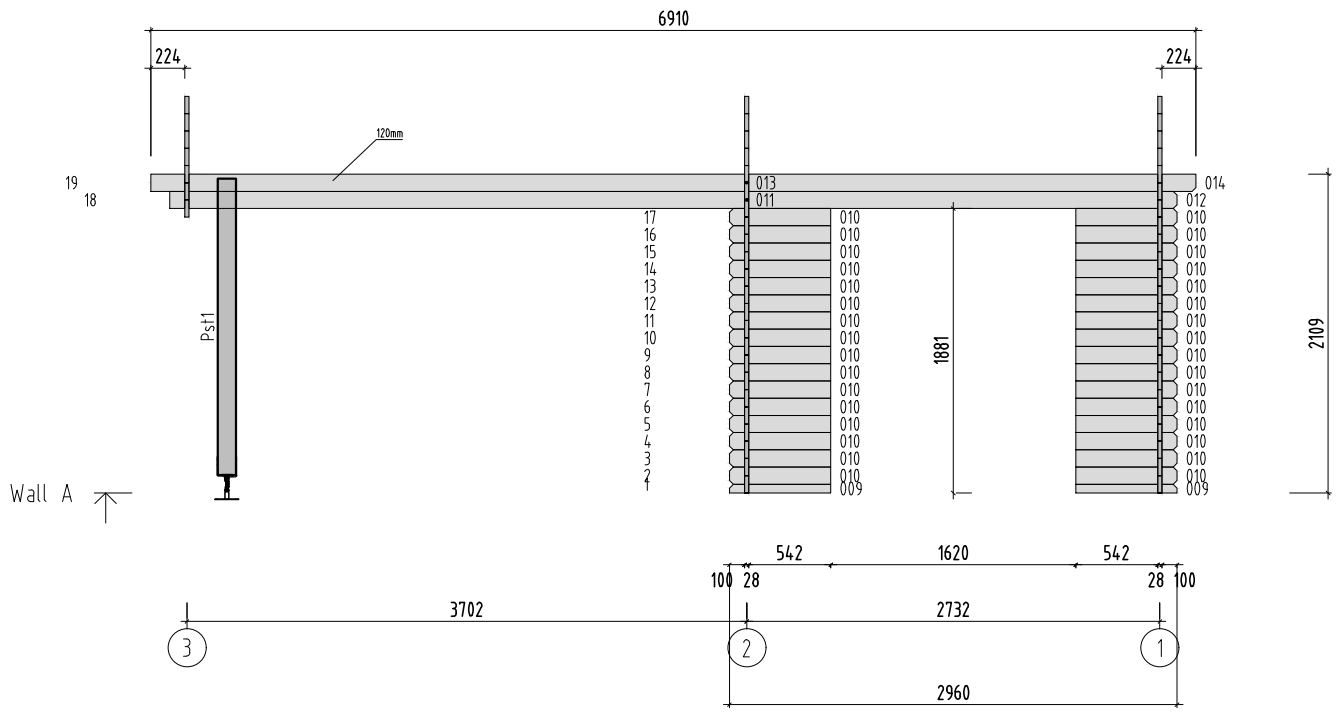

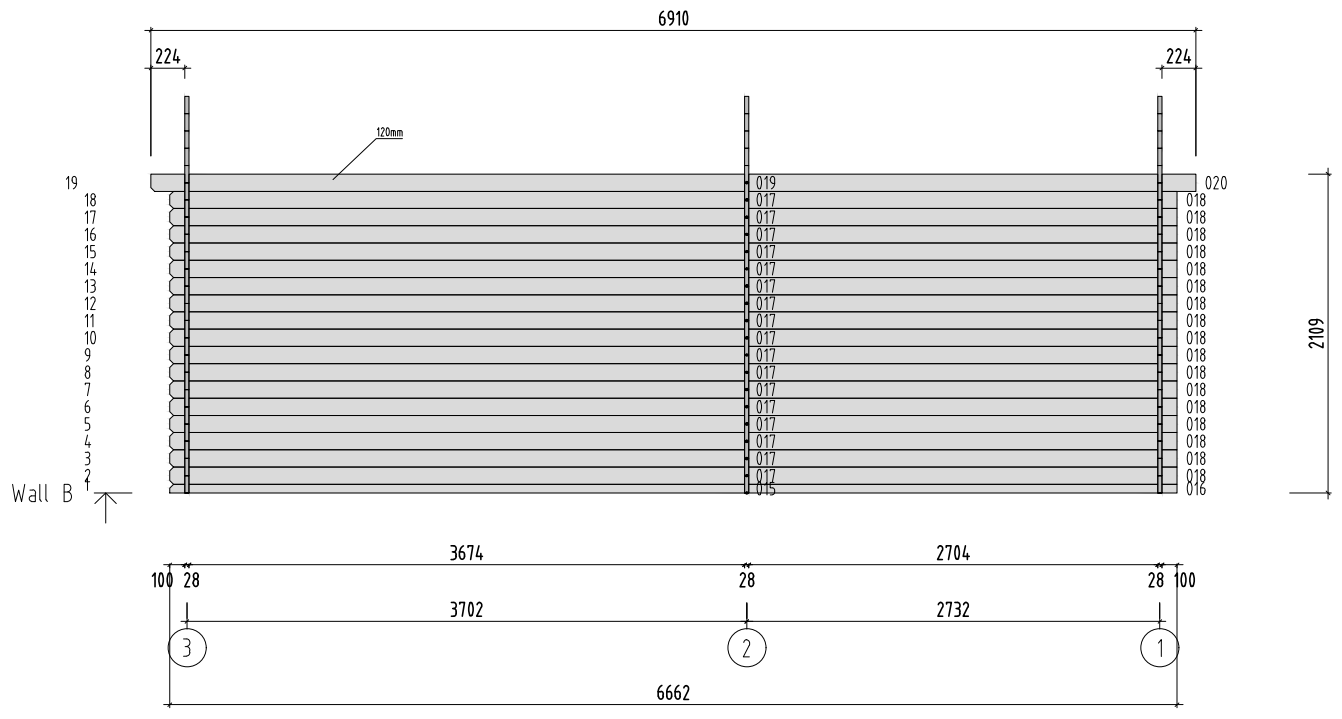

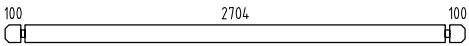
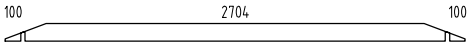

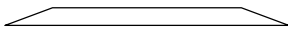



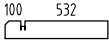
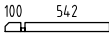
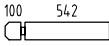
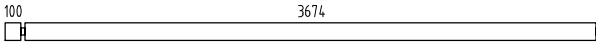
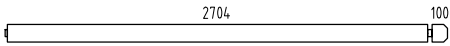
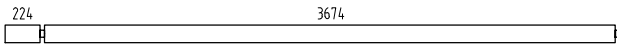
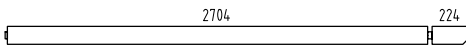
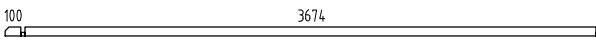
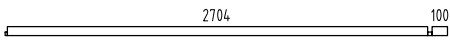
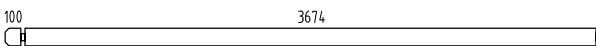
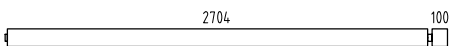
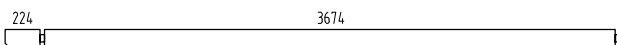
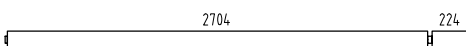
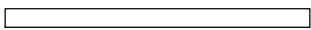
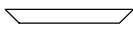
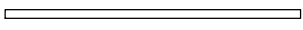
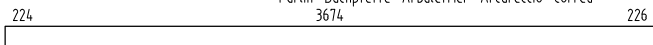
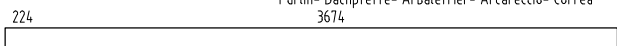



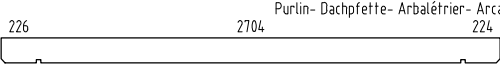
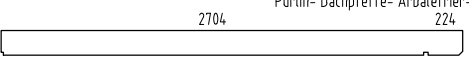
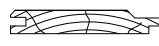







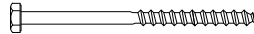
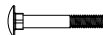
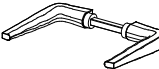
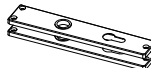
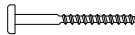









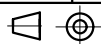

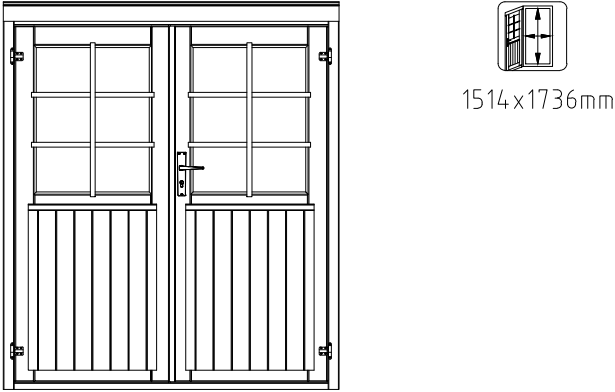

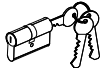
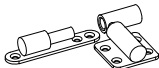
Pos	SPECIFICATION-STÜCKLISTE-NOMENCLATURE-ELEMENTI-ESPECIFICACIÓN FR28-5730	Pcs	Profile (mm)	Length (mm)
001		37	28x114	2960
002		3	28x114	2960
003		3	28x114	2432
004		3	28x114	1824
005		3	28x114	1216
006		6	28x103	274
007		17	28x114	530
008		1	28x114	660
009		2	28x57	670
010		32	28x114	670
011		1	28x114	3816
012		1	28x114	2846
013		1	28x114	3940
014		1	28x114	2970
015		1	28x57	3816
016		1	28x57	2846
017		17	28x114	3816
018		17	28x114	2846
019		1	28x114	3940
020		1	28x114	2970
Pst1	Post- Pfosten- Poteau- Montante- Poste 	1	120x120	1960
SP1	Support brace- Stützleiste- Baguette de support- Listello di supporto- Listón de soporte 	1	90x90	825
UP1	U-profile board- U-Profilleiste- Baguette profilée en U- Listello profilo ad U- Listón de perfil U 	1	25x55	1900
PR1	Purlin- Dachpfette- Arbalétrier- Arcareccio- Correa 	2	60x160	4180
PR3	Purlin- Dachpfette- Arbalétrier- Arcareccio- Correa 	1	60x160	3940



Pos	SPECIFICATION-STÜCKLISTE-NOMENCLATURE-ELEMENTI-ESPECIFICACIÓN FR28-5730	Pcs	Profile (mm)	Length (mm)
PR2	 Purlin- Dachpfette- Arbalétrier- Arcareccio- Correa	2	60x160	3210
PR4	 Purlin- Dachpfette- Arbalétrier- Arcareccio- Correa	1	60x160	2970
RB1-1	Roof board- Dachbrett- Madrier du toit- Tavola tetto- Tabla de tejado 	156	89x16	1640
Dia-1	Diamond- Deckbrett- Madrier- Tavola di copertura- Rombo 	2	19x140	240
EaE2-1	Eave edging- Dachrandbrett- Madrier en bordure du toit- Tavola bordo tetto- Tabla de valadizo 	4	16x120	3455
FaB3-1	Facia board- Giebelblende- Écran frontal- Schermo frontone- Tabla de facia 	4	16x120	1680
RE2-1	Roof edge reinforcement- Dachrandleiste- Baguette en bordure du toit- Rinforzo bordo tetto- Refuerzo borde tejado 	2	32x40	3000
RE2-2	Roof edge reinforcement- Dachrandleiste- Baguette en bordure du toit- Rinforzo bordo tetto- Refuerzo borde tejado 	2	32x40	3910
StB1-1	Storm brace- Sturmleiste- Protection contre le vent- Antivento- Protector contra tormentas 	5	25x45	2100
WB1-1	Wind brace- Windbrett- Madrier contre le vent- Tavola vento- Tabla contra el viento 	4	16x45	1680
Fim	-Fixing kit- Befestigungsset- Moyens de fixation- Materiale di fissaggio- Kit de fijación	1		
QLA80	Adjustment bolt - Senkbolzen - Boulon de réglage - Bullone di regolamento- Perno de ajuste 	1		
QKRKK8 x160Zn	Bolt -Schloss-schraube -Boulon- Bullone- Perno- 8x160mm KSKR 	2		
QPOYP 8x60Zn	Bolt -Schloss-schraube -Boulon- Bullone- Perno- M8x60mm PUP0 	10		
QLIUHb	Door fittings- Türbeschlag- Ferrure- Ferramenta porta- Manilla puerta- QLIUHb 	1		
QULKAK	Door fittings- Türbeschlag- Ferrure- Ferramenta porta- Manilla puerta- QULKAK 	1		
QKRYP 6 3x8 0kZnSK	Furniture screw- Innensechskantschraube- Vis Allen- Vite Allen- Tornillo Allen- 6.3x80mm 	2		
QKA20	Hole plug- Abdeckkappe- Cache-vis- Tappi in legno- Embellecedor- QKA20 	2		
QTK60 x160Zn	Joist hanger- Balkenschuhe- Étrier a solive- Gancio travetto- Suspensión de la viga- QTK60x160Zn 	2		
QNA2 2x50Zn	Nail- Nagel- Clou- Chiodo- Clavo- 2.5x50mm 	500		
QMUK K8Zn	Nut- Schraubenmutter- Écrou- Dado- Tuerca- M8mm 	10		
QKRPP3 5x40Zn	Screw- Schraube- Vis- Vite- Tornillo- 3.5x40mm 	120		
QKRPP4 5x70Zn	Screw- Schraube- Vis- Vite- Tornillo- 4.5x70mm 	25		
QKRYP5 x40ZnTX	Screw- Schraube- Vis- Vite- Tornillo- 5x40mm 	14		
QKRPP 5x90Zn	Screw- Schraube- Vis- Vite- Tornillo- 5x90mm 	12		

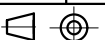

Pos	SPECIFICATION-STÜCKLISTE-NOMENCLATURE-ELEMENTI-ESPECIFICACIÓN FR28-5730	Pcs	Profile (mm)	Length (mm)
TU28 -32P	Door - Tür - Porte - Porta-Puerta 1610x1824 	1		
SiS6-1	Side slat - Randleiste - Baguette en bordure - Listello bordo 6 	2	28x95	1650
QULSI 30x30	Cylinder- Zylinderschloss- Serrure a mortaiser- Serratura a cilindro- Bombin- 30.30 	1		
QHP15 x57Zn	Door hinge- Türbänder- Charniere de porte- Cerniere porta- Bisagra de puerta- QHP15x57Zn 	4		
QRV1 20Zn	Keeper- Schliessblech- Tole- Lamiera- Aldaba de candado- 120Zn 	2		
QKRPP2 _5x16Zn	Screw- Schraube- Vis- Vite- Tornillo- 2.5x16mm Zn 	4		
QKRPP3 _5x25Zn	Screw- Schraube- Vis- Vite- Tornillo- 3.5x25mm Zn 	16		
QKRPP 3x20Zn	Screw- Schraube- Vis- Vite- Tornillo- 3x20mm 	12		
QKRPP 3x30Zn	Screw- Schraube- Vis- Vite- Tornillo- 3x30mm 	10		
QKRPP 4x50Zn	Screw- Schraube- Vis- Vite- Tornillo- 4x50mm Zn 	12		
QKRPP 5x90Zn	Screw- Schraube- Vis- Vite- Tornillo- 5x90mm 	8		
QSE21 x25Zn	Washer- Dichtscheibe- Joint- Rondella- Arandela- 21x25mm 	2		
	Object name FR28-5730	Page		4/4

