

Mekong
Art.Nr.702241

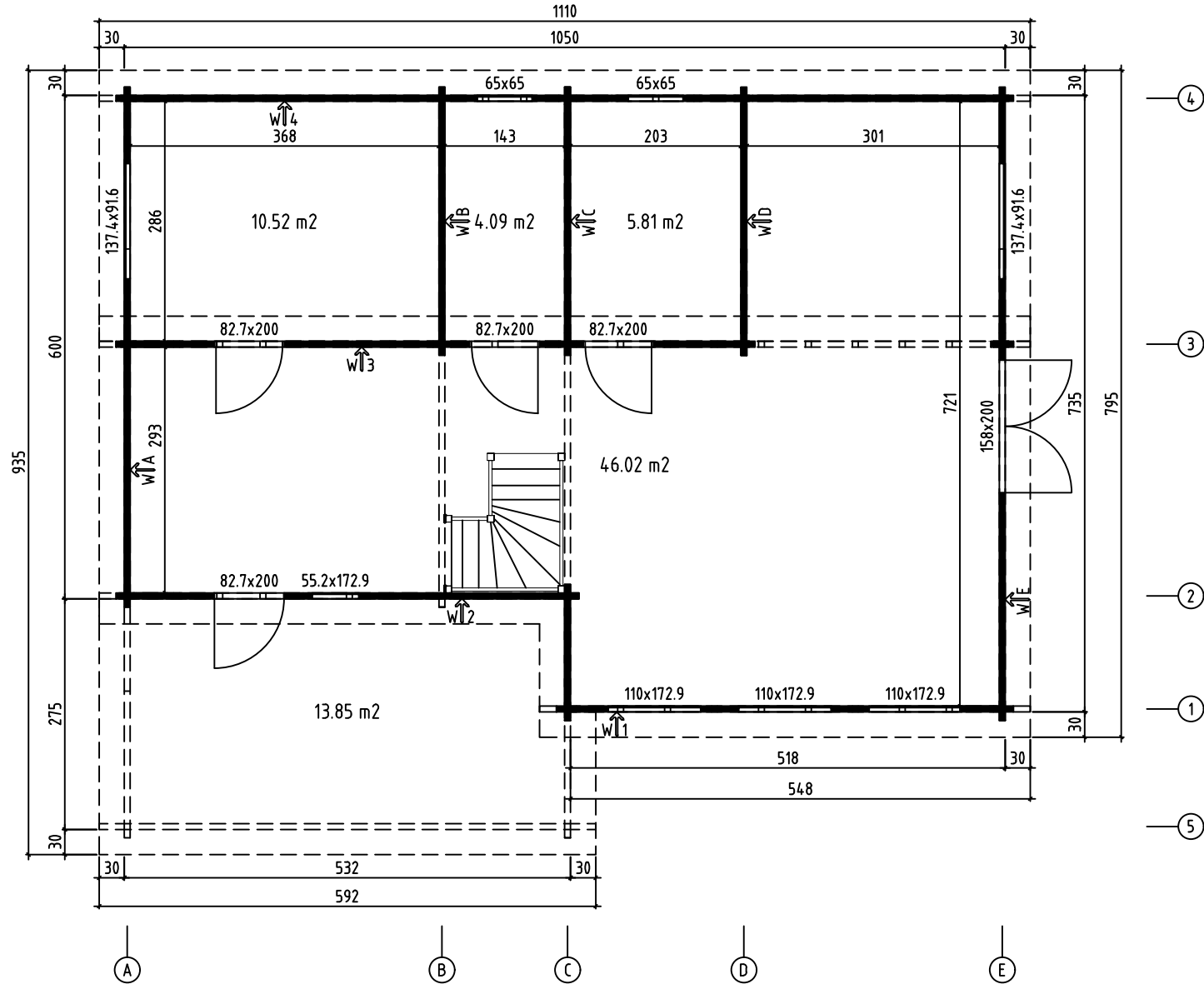

Mekong, Art.Nr.702241
 Groundplan - Grundplan - Plan de masse - Planimetria -
 Plattegrond - Põhiplaan



Mekong, Art.Nr.702241

Groundplan - Grundplan - Plan de masse - Planimetria - Plattegrond - Põhiplan

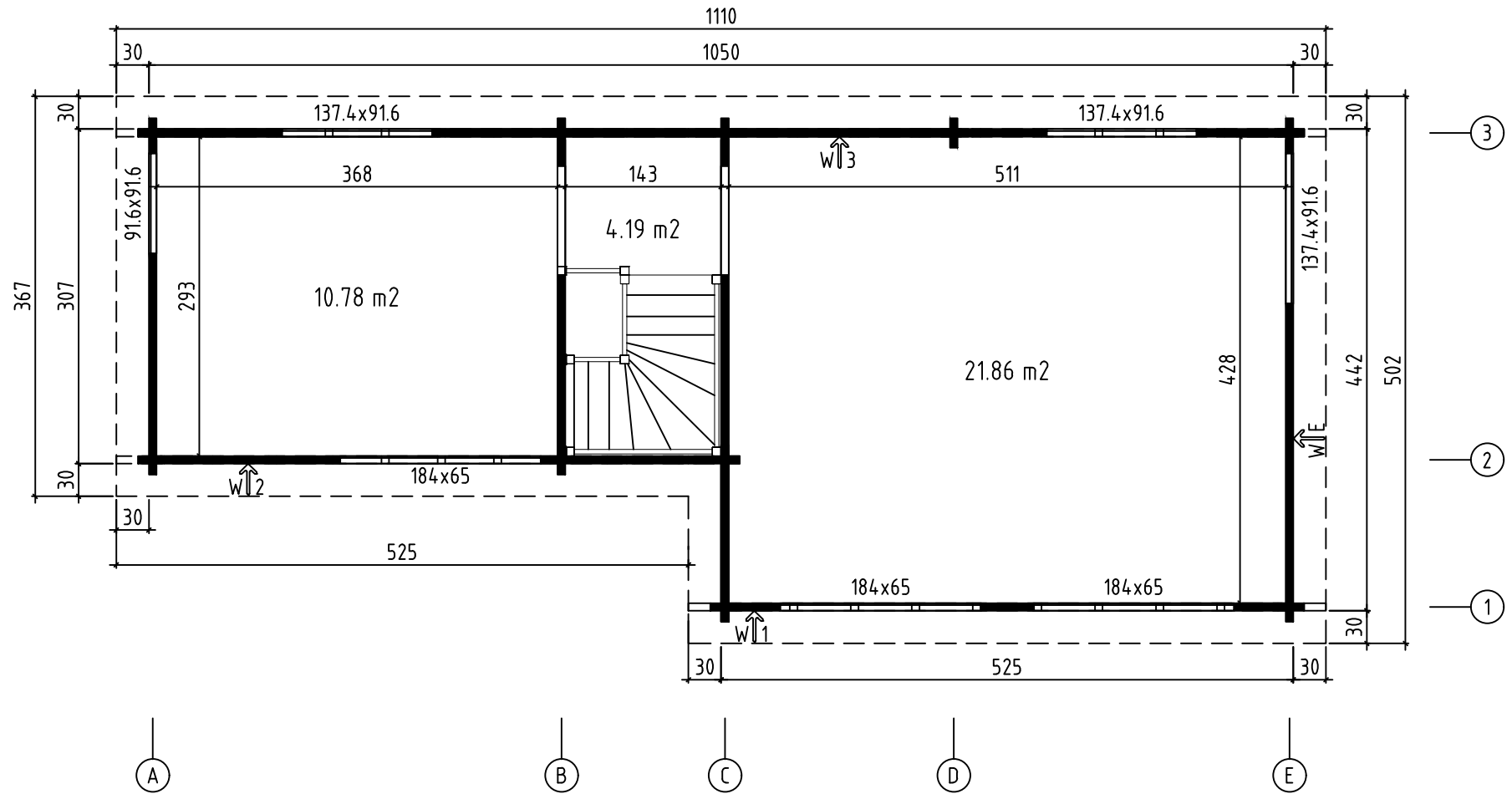

Mekong, Art.Nr.702241
Floor boards - Fussbodenbretter - Plan pose plancher - Pavimento -
Vloerhout - Põrandalaudis

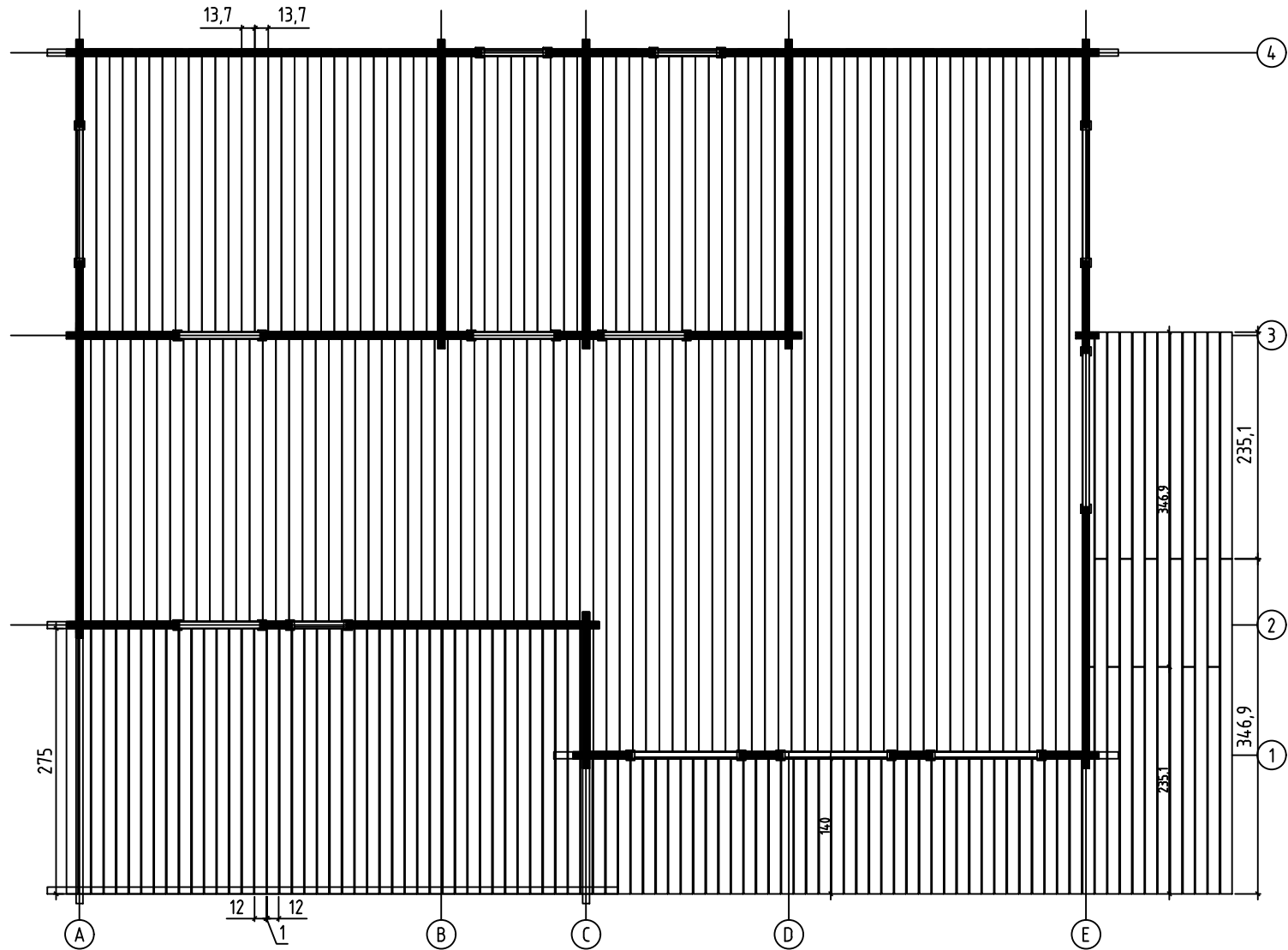

Mekong, Art.Nr.702241

Floor boards - Fussbodenbretter - Plan pose plancher - Pavimento - Vloerhout -
Põrandalaudis

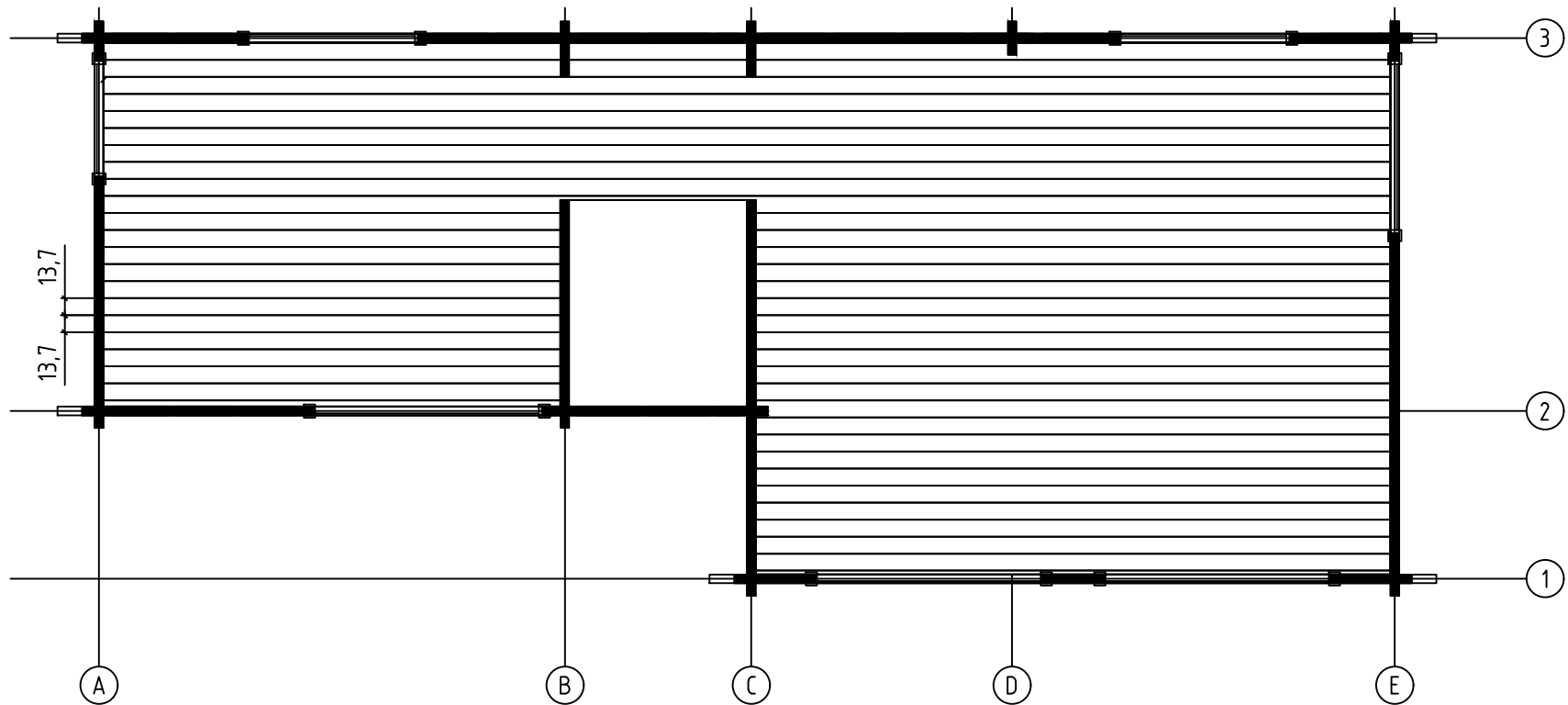

Mekong, Art.Nr.702241
 Rafter plan - Dachsparren - Plan de chevron - Piano di travi -
 Dak spar constructie plattegrond - Sarikaplaan

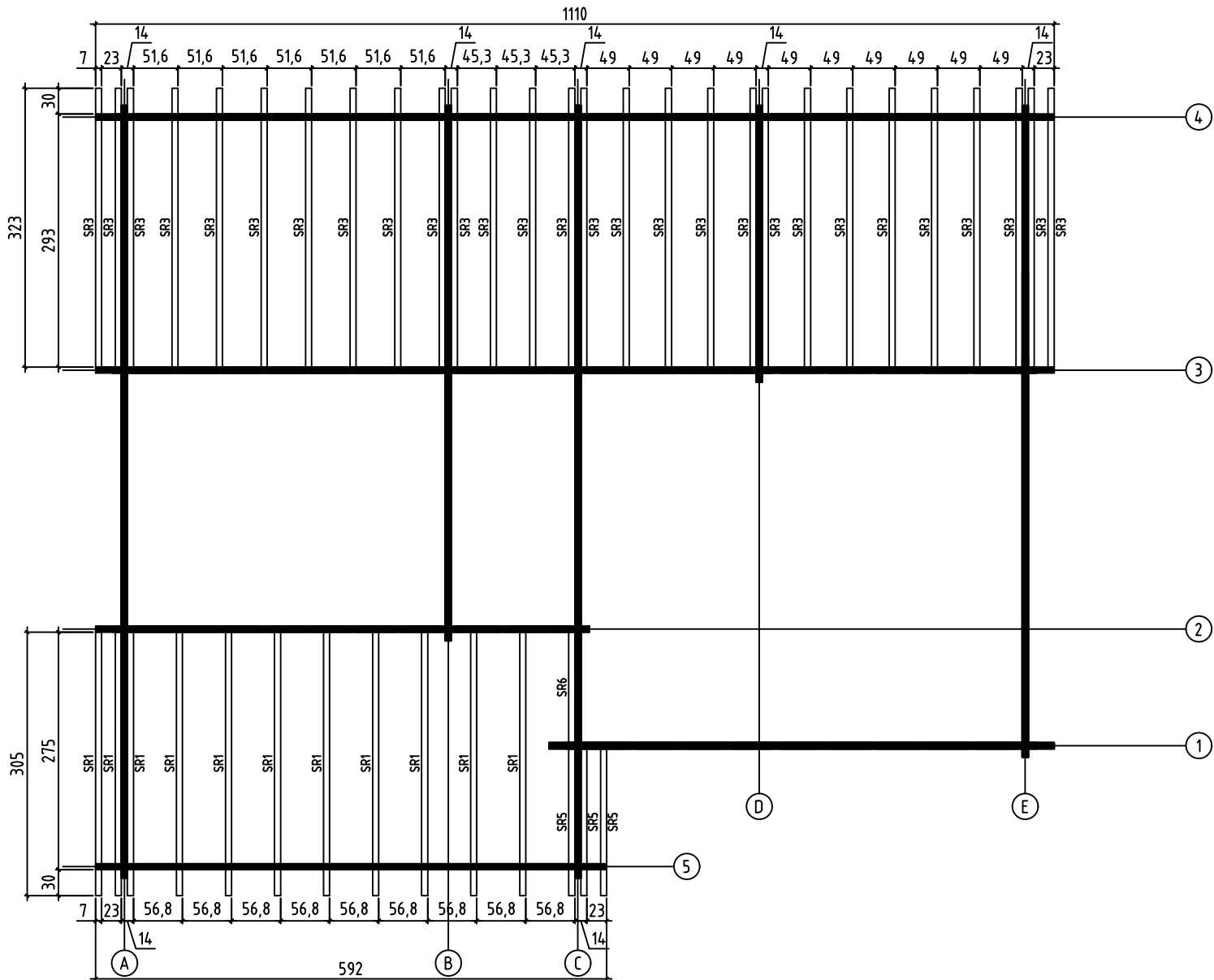

Mekong, Art.Nr.702241

Roof plan - Dach-plan - Plan du toit - Piano del tetto - Dak plattegrond - Katuseplan

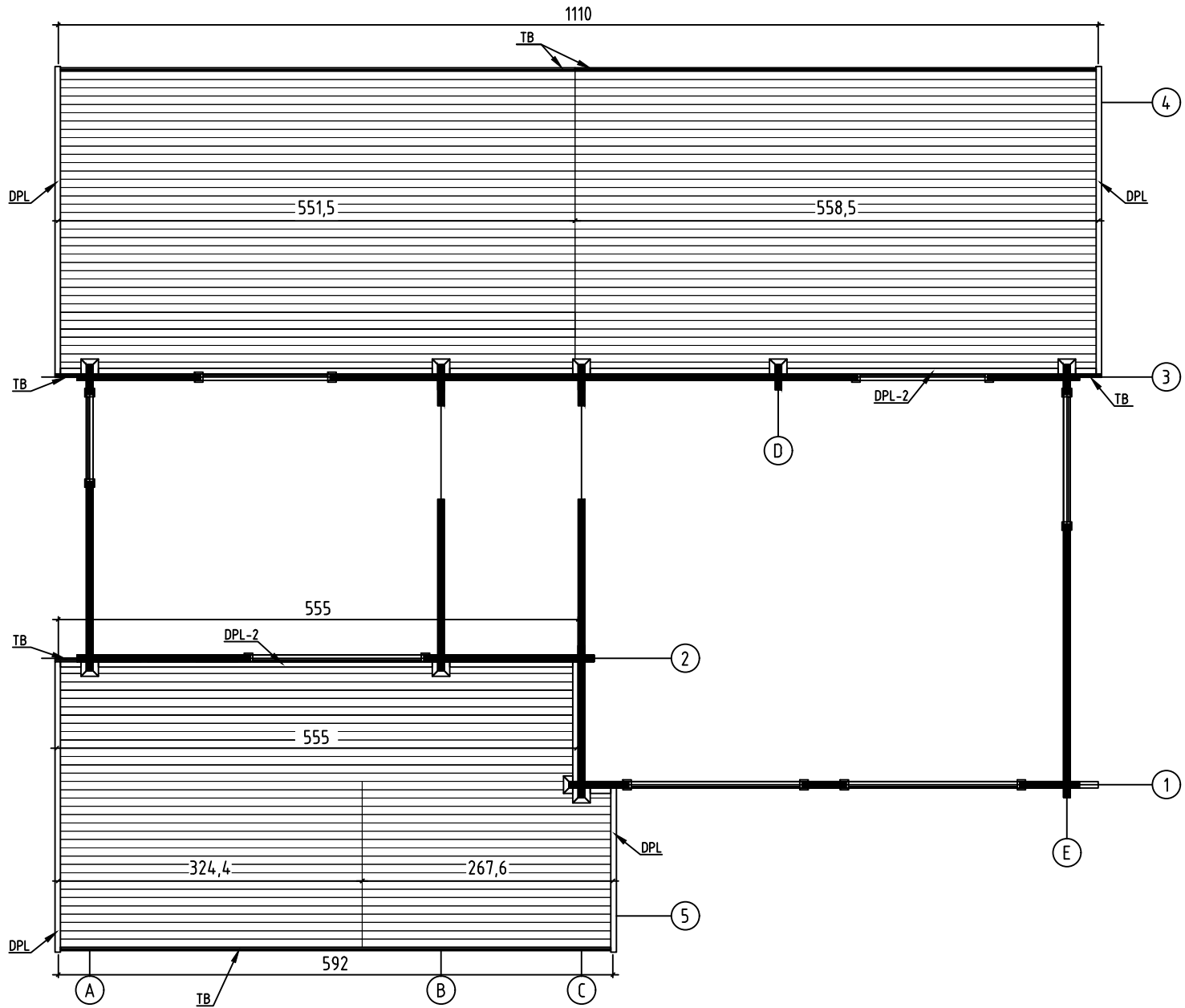

Mekong, Art.Nr.702241
 Roof plan - Dach-plan - Plan du toit - Piano del tetto - Dak
 plattegrond - Katuseplaan

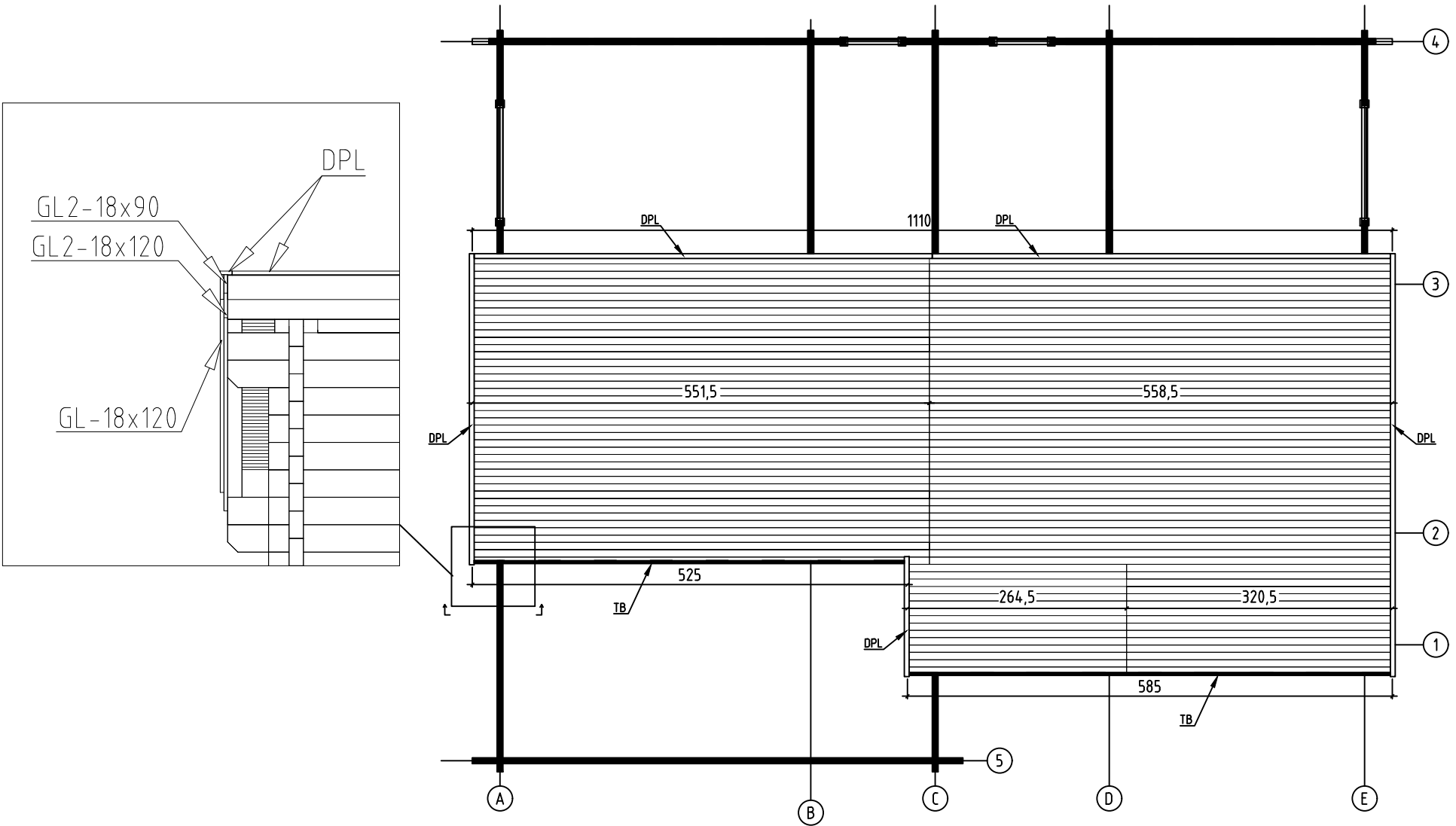

Mekong, Art.Nr.702241

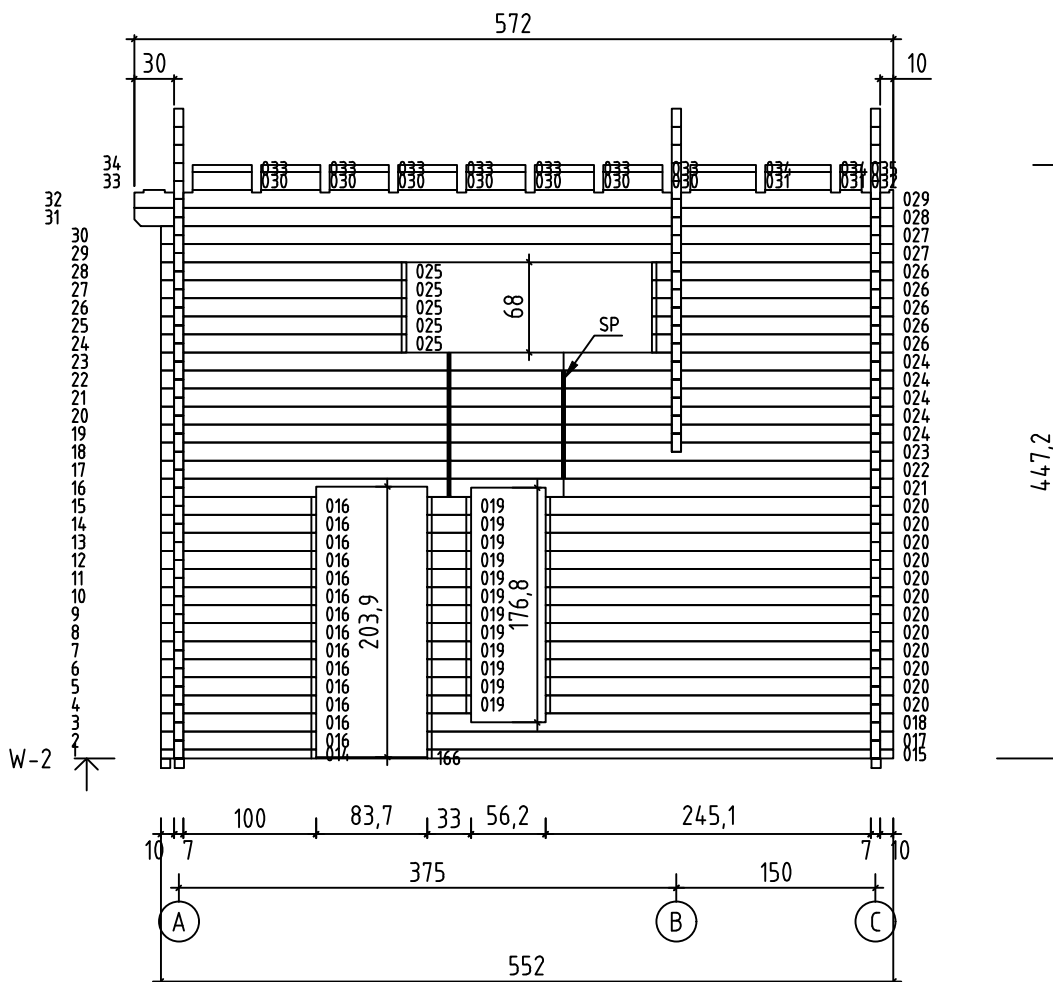
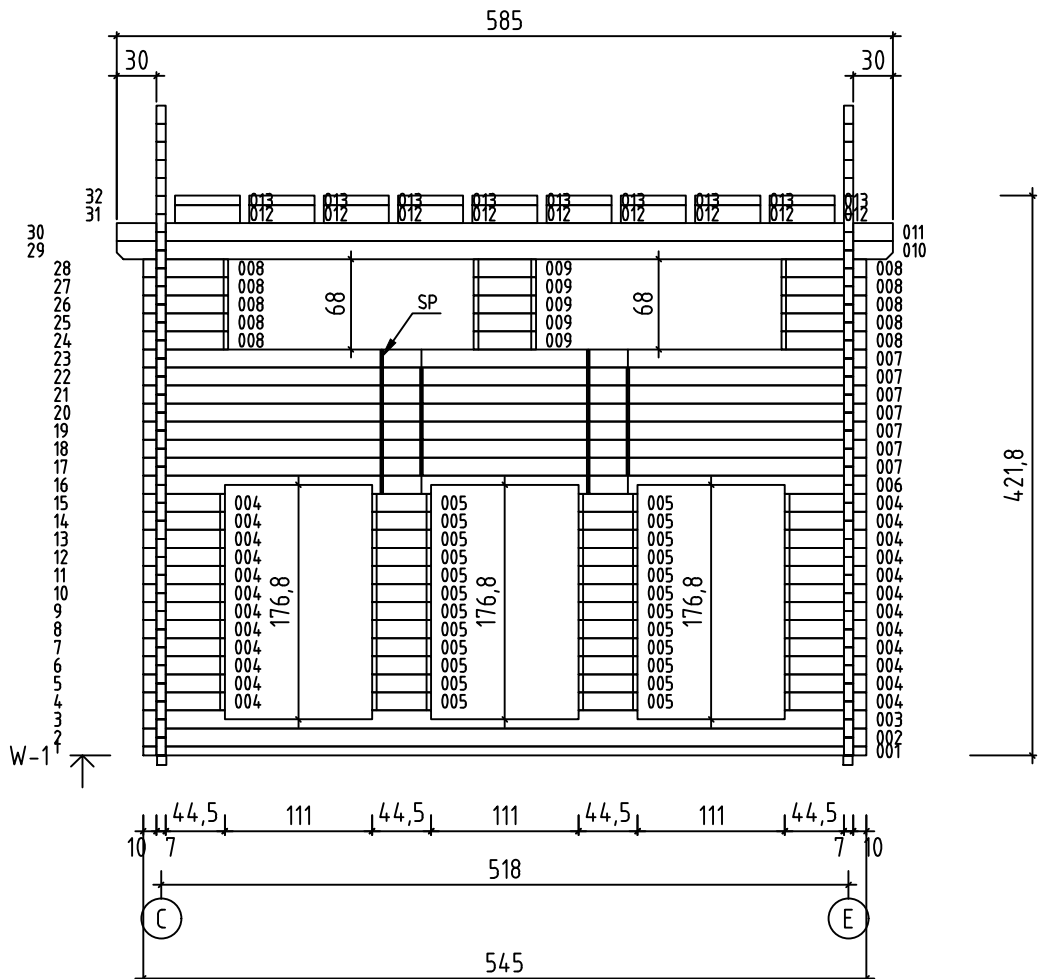

Mekong, Art.Nr.702241

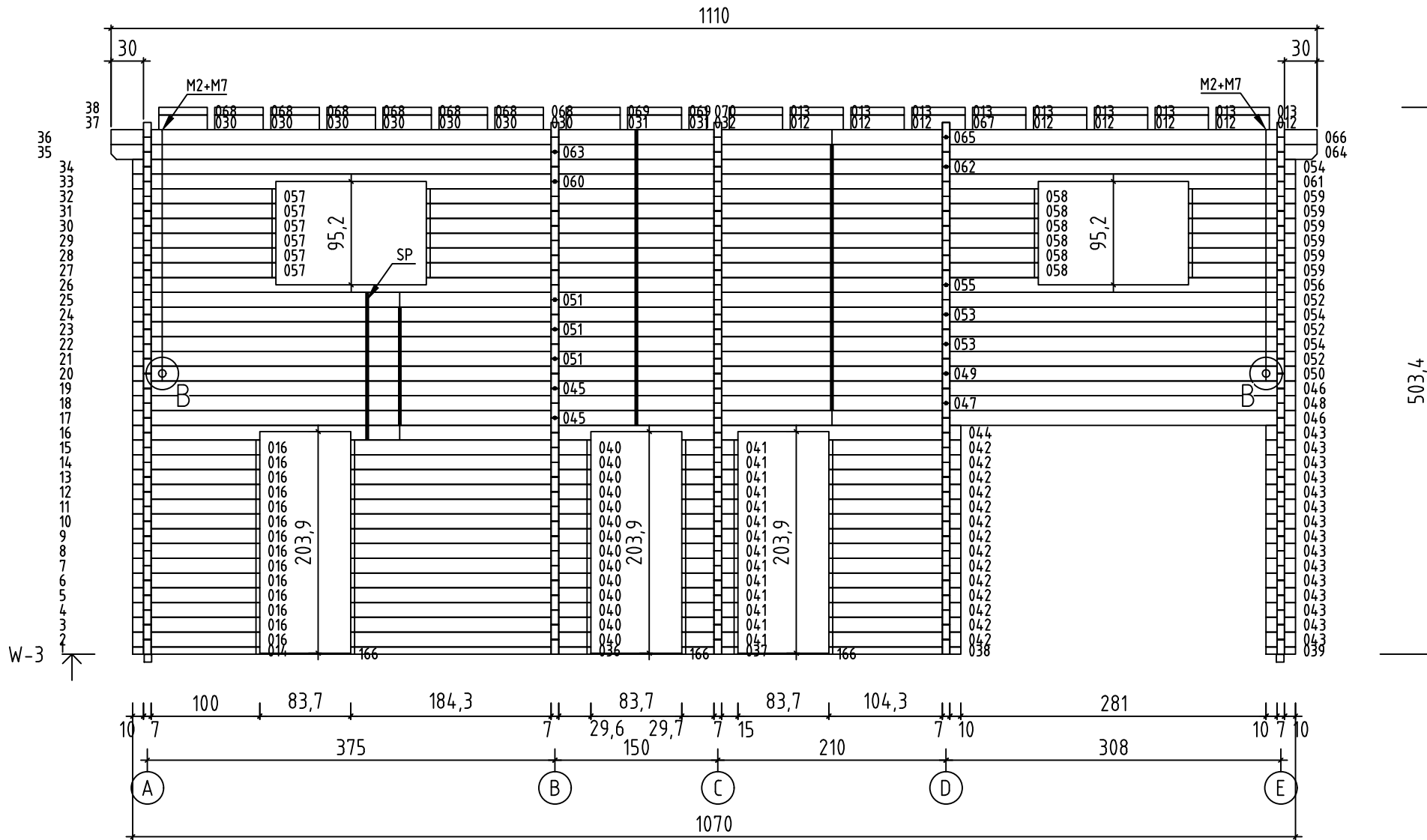



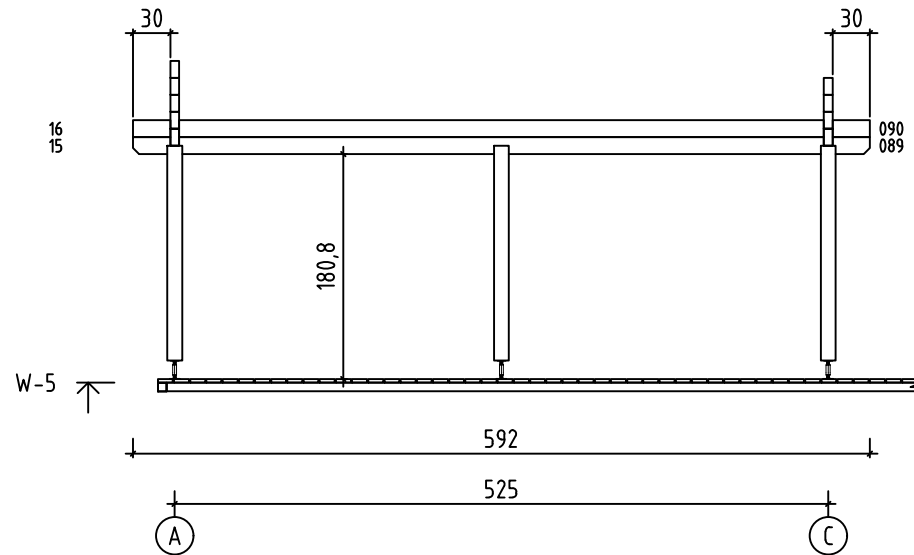
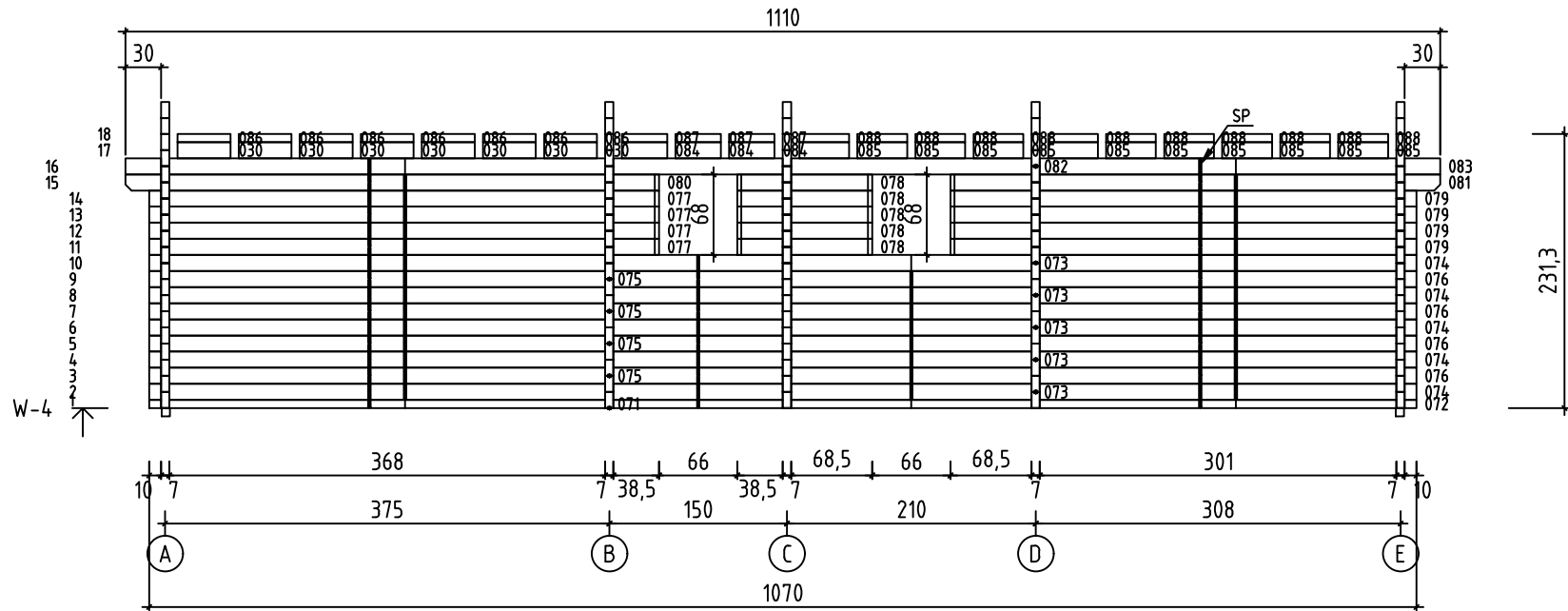

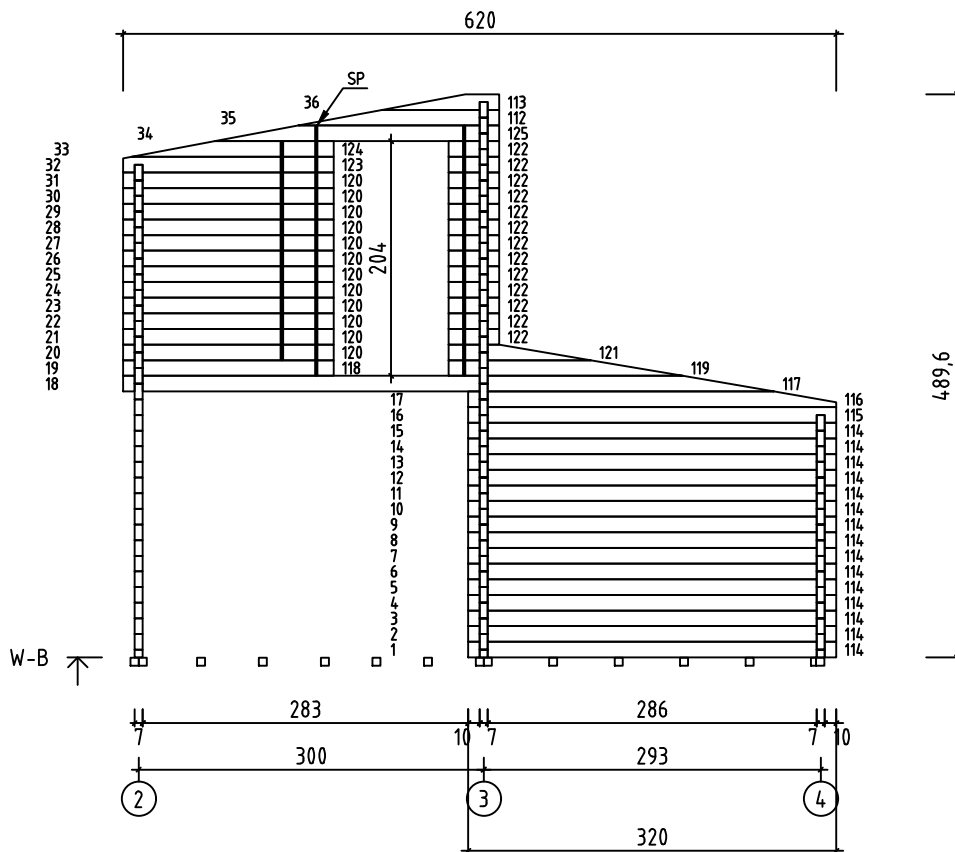
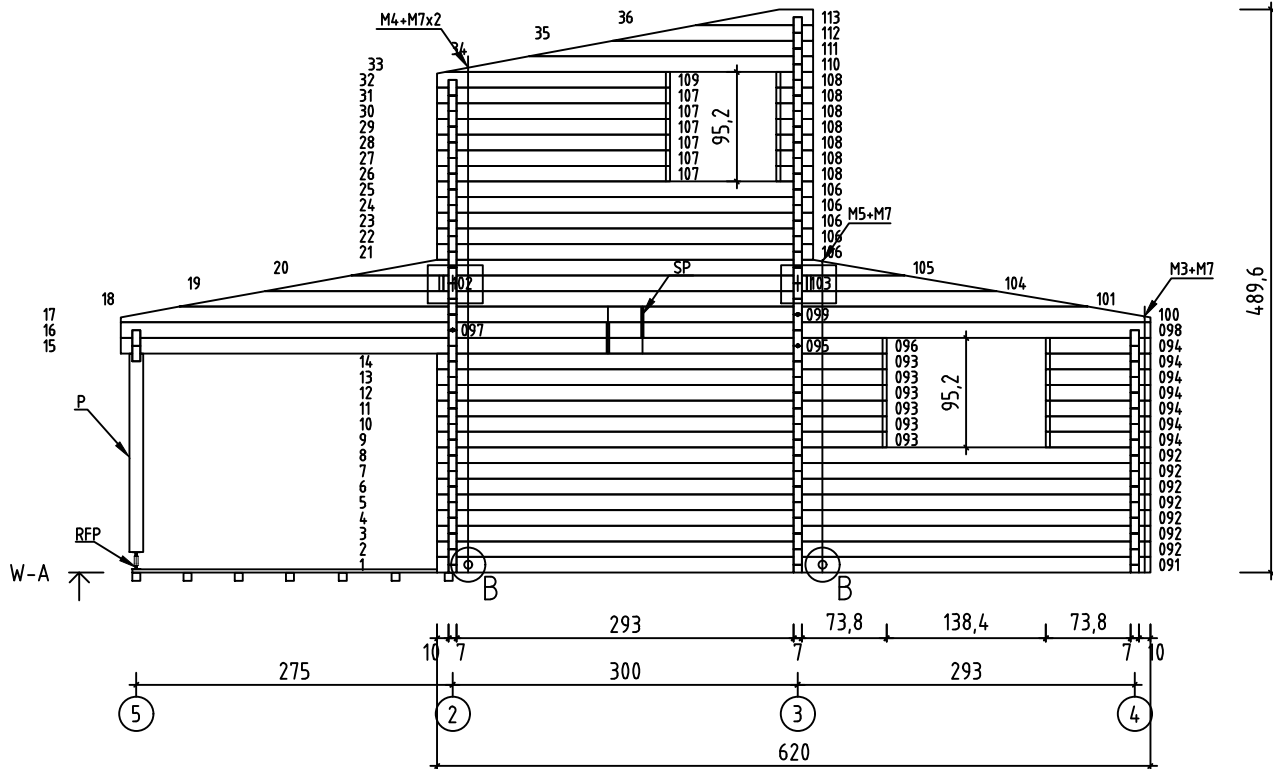
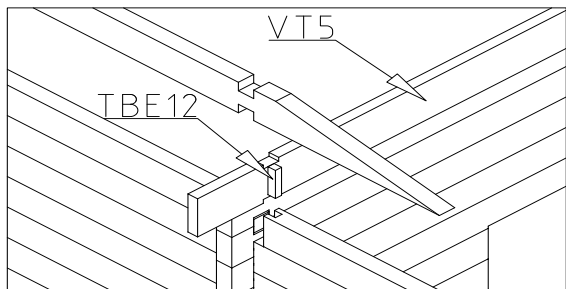

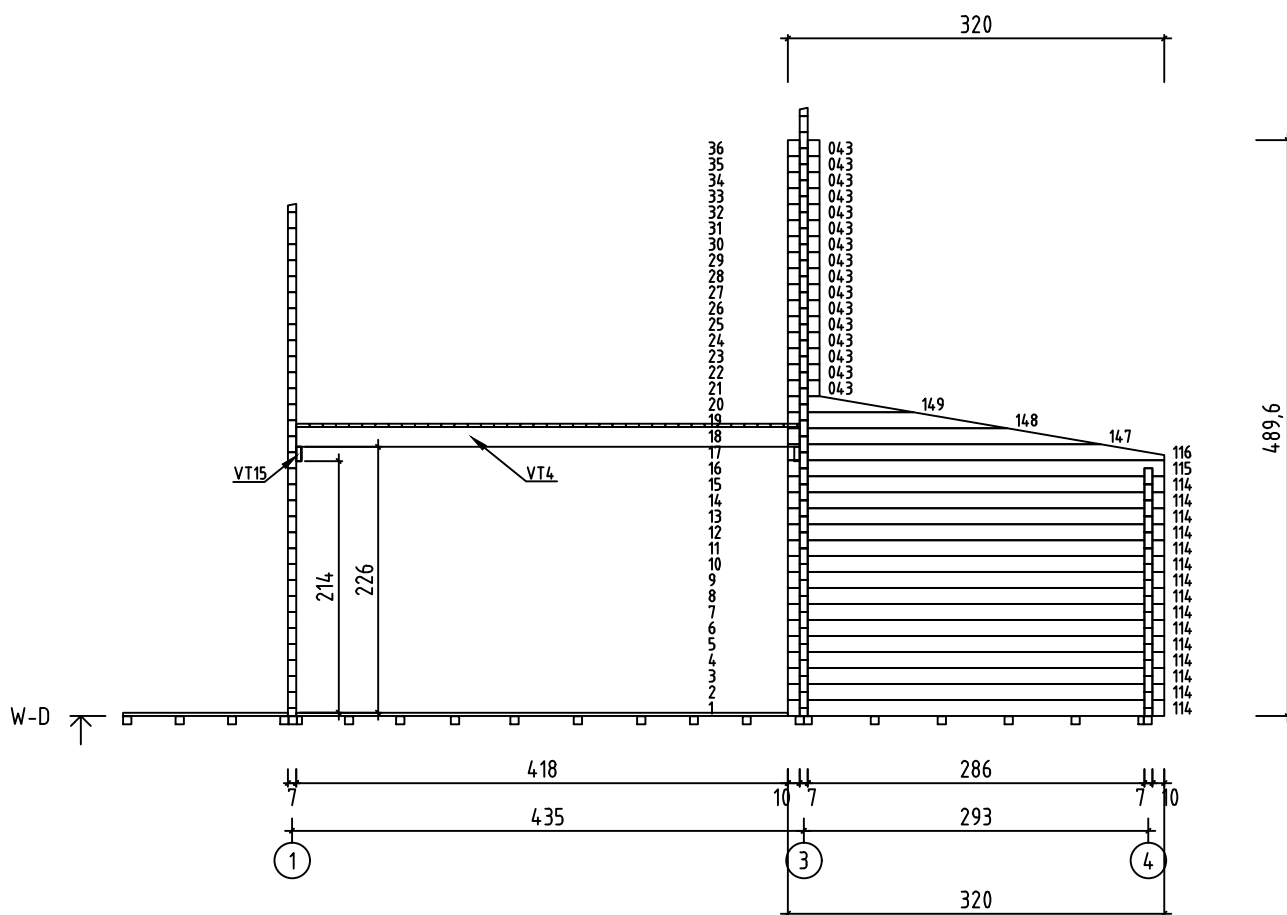
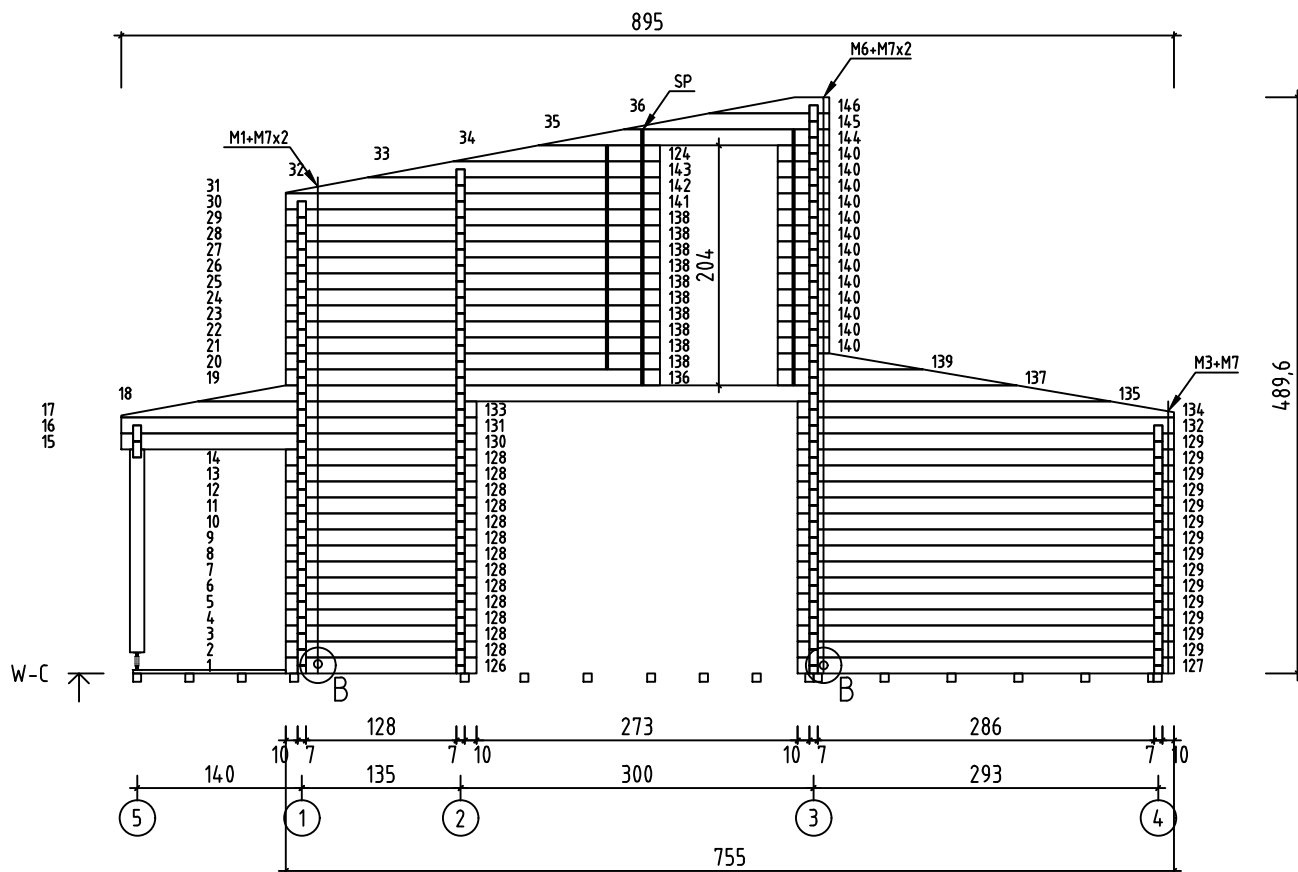

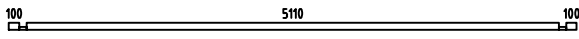
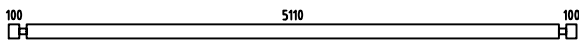
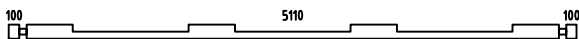
Mekong, Art.Nr.702241

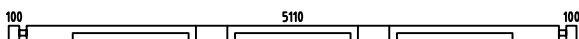
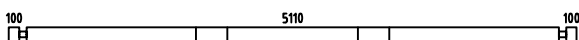

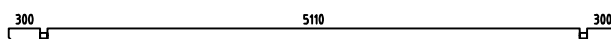
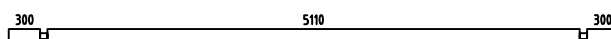

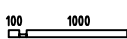
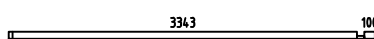
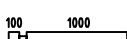
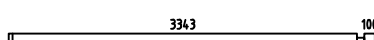
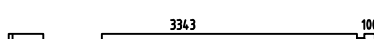

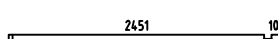
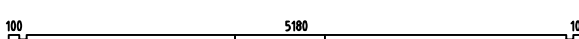
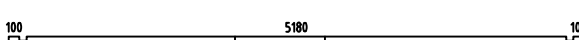
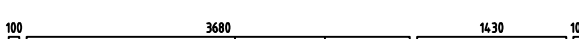



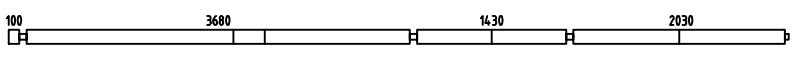
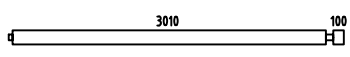
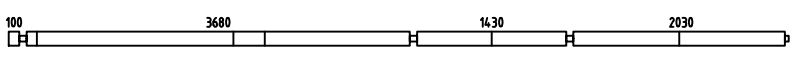
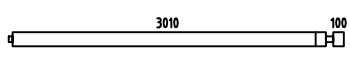
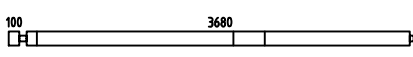
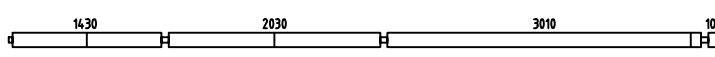
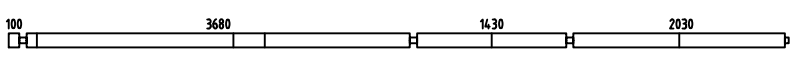
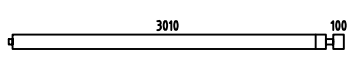
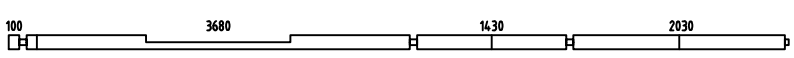
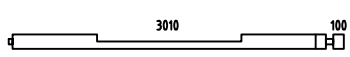
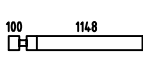
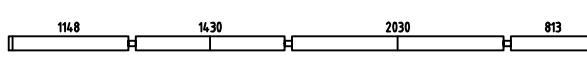
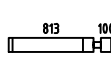
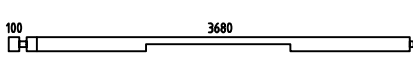
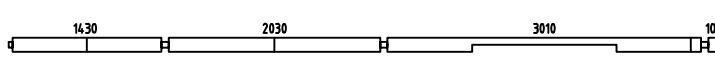
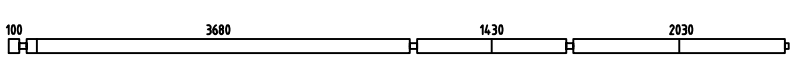
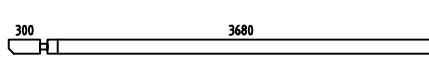
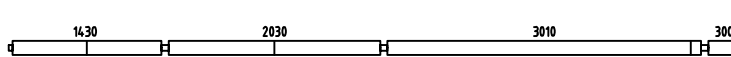

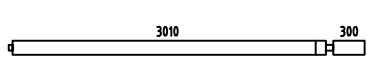







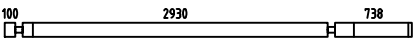
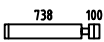
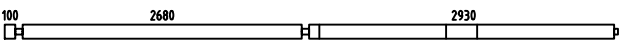

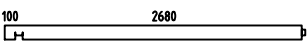
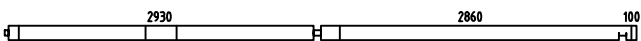
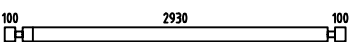
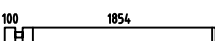

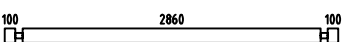
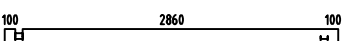
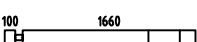

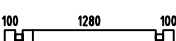
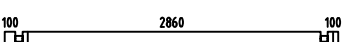
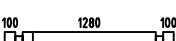
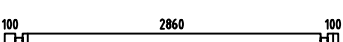
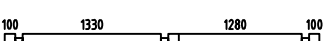
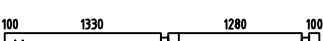
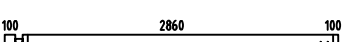
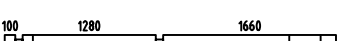

Pos	Mekong, Art.Nr.702241 Piece list - Stückliste - Liste des pièces - Elementi - Stuklijst - Tükítabel	Q	P (mm)	L (mm)
001		1	70x68	5450
002		1	70x136	5450
003		1	70x136	5450
004		24	70x136	615
005		24	70x136	445
006		1	70x136	5450
007		7	70x136	5450
008		10	70x136	640
009		5	70x136	470
010		1	70x136	5850
011		1	70x136	5850
012		17	70x136	490
013		18	70x70	490
014		2	70x68	1170
015		1	70x68	3513
016		28	70x136	1170
017		1	70x136	3513
018		1	70x136	3513
019		12	70x136	330
020		12	70x136	2621
021		1	70x136	5520
022		1	70x136	5520
023		1	70x136	5520

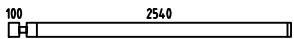
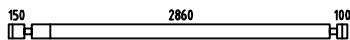
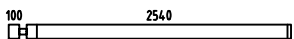
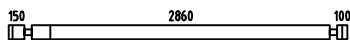
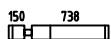
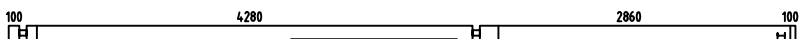
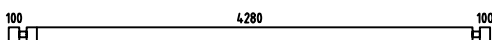
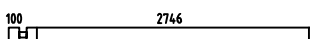
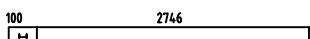

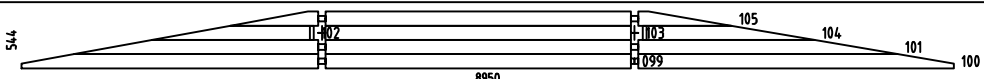

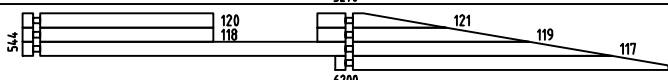
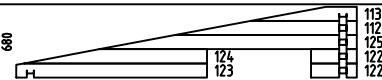
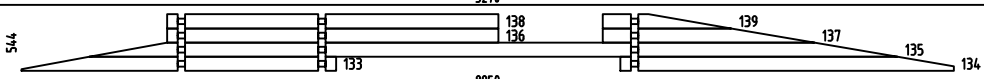

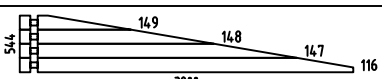
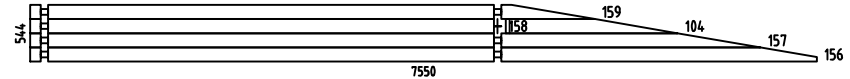
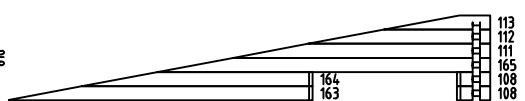



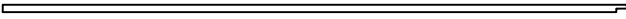

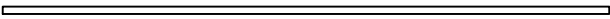

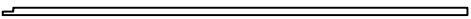

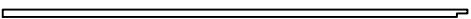

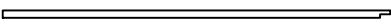



Pos	Mekong, Art.Nr.702241 Piece list - Stückliste - Liste des pièces - Elementi - Stuklijst - Tükítabel	Q	P (mm)	L (mm)
024		5	70x136	5520
025		5	70x136	1850
026		5	70x136	1820
027		2	70x136	5520
028		1	70x136	5720
029		1	70x136	5720
030		21	70x136	446
031		4	70x136	495
032		2	70x136	160
033		7	70x52	446
034		2	70x52	495
035		1	70x52	160
036		1	70x68	2210
037		1	70x68	517
038		1	70x68	1213
039		1	70x68	270
040		14	70x136	2209
041		14	70x136	517
042		14	70x136	1213
043		31	70x136	270
044		1	70x136	7620
045		2	70x136	3885
046		2	70x136	6815







Pos	Mekong, Art.Nr.702241 Piece list - Stückliste - Liste des pièces - Elementi - Stuklijst - Tükítabel	Q	P (mm)	L (mm)
047		1	70x136	7485
048		1	70x136	3215
049		1	70x136	7485
050		1	70x136	3215
051		3	70x136	3885
052		3	70x136	6815
053		2	70x136	7485
054		3	70x136	3215
055		1	70x136	7485
056		1	70x136	3215
057		6	70x136	1318
058		6	70x136	5631
059		6	70x136	983
060		1	70x136	3885
061		1	70x136	6815
062		1	70x136	7485
063		1	70x136	4085
064		1	70x136	7015
065		1	70x136	7685
066		1	70x136	3415
067		1	70x136	490
068		7	70x70	446
069		2	70x70	495

Pos	Mekong, Art.Nr.702241 Piece list - Stückliste - Liste des pièces - Elementi - Stuklijst - Tükítabel	Q	P (mm)	L (mm)
070		1	70x70	160
071		1	70x68	3885
072		1	70x68	6815
073		5	70x136	7485
074		5	70x136	3215
075		4	70x136	3885
076		4	70x136	6815
077		4	70x136	4305
078		5	70x136	1140
079		4	70x136	3935
080		1	70x136	4505
081		1	70x136	4135
082		1	70x136	7685
083		1	70x136	3415
084		3	70x136	383
085		10	70x136	420
086		7	70x69	446
087		3	70x69	383
088		10	70x69	420
089		1	70x136	5920
090		1	70x136	5920
091		1	70x136	6200
092		7	70x136	6200

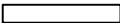
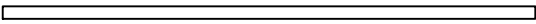
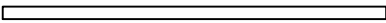
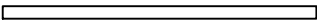
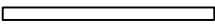
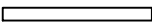

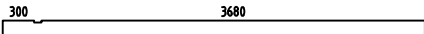
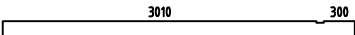
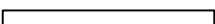



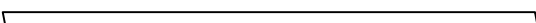
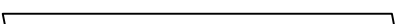
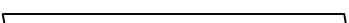
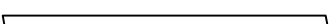
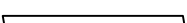
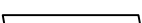
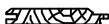
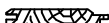
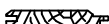
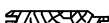













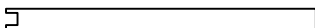

Pos	Mekong, Art.Nr.702241 Piece list - Stückliste - Liste des pièces - Elementi - Stuklijst - Tükítabel	Q	P (mm)	L (mm)
093		6	70x136	3908
094		14	70x136	908
095		1	70x136	5885
096		1	70x136	773
097		1	70x136	2885
098		1	70x136	6065
106		5	70x136	3270
107		6	70x136	2024
108		11	70x136	320
114		30	70x136	3200
115		2	70x136	3200
120		11	70x136	1830
122		11	70x136	440
126		1	70x136	1620
127		1	70x136	3200
128		13	70x136	1620
129		14	70x136	3200
130		1	70x136	3020
131		1	70x136	3020
132		1	70x136	3200
138		9	70x136	3180
140		10	70x136	440
141		1	70x136	3180

Pos	Mekong, Art.Nr.702241 Piece list - Stückliste - Liste des pièces - Elementi - Stuklijst - Tükítabel	Q	P (mm)	L (mm)
150		1	70x136	2710
151		1	70x136	3250
152		14	70x136	2710
153		7	70x136	3250
154		7	70x136	958
155		1	70x136	7550
160		5	70x136	4620
161		4	70x136	2916
162		1	70x136	2916
166		4	70x10	837
167		1	70x10	1590
WA-1		1		
WA-2		1		
WB-1		1		
WB-2		1		
WC-1		1		
WC-2		1		
WD-1		1		
WE-1		1		
WE-2		1		
IAR12	Foundation - Fundament - Fondation - Fondamenta - Fundering - Inmutfatud alusraam 	6	70x70	5990











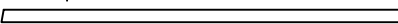
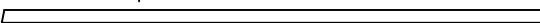











Pos	Mekong, Art.Nr.702241 Piece list - Stückliste - Liste des pièces - Elementi - Stuklijst - Tükítabel	Q	P (mm)	L (mm)
IAR7	Foundation - Fundament - Fondation - Fundamenta - Fundering - Immutatud alusraam 	7	70x70	5990
IAR2	Foundation - Fundament - Fondation - Fundamenta - Fundering - Immutatud alusraam 	1	70x70	5960
IAR6	Foundation - Fundament - Fondation - Fundamenta - Fundering - Immutatud alusraam 	1	70x70	5820
IAR15	Foundation - Fundament - Fondation - Fundamenta - Fundering - Immutatud alusraam 	3	70x70	5285
IAR16	Foundation - Fundament - Fondation - Fundamenta - Fundering - Immutatud alusraam 	3	70x70	5100
IAR8	Foundation - Fundament - Fondation - Fundamenta - Fundering - Immutatud alusraam 	9	70x70	4460
IAR18	Foundation - Fundament - Fondation - Fundamenta - Fundering - Immutatud alusraam 	4	70x70	4460
IAR11	Foundation - Fundament - Fondation - Fundamenta - Fundering - Immutatud alusraam 	8	70x70	4460
IAR5	Foundation - Fundament - Fondation - Fundamenta - Fundering - Immutatud alusraam 	1	70x70	3720
IAR4	Foundation - Fundament - Fondation - Fundamenta - Fundering - Immutatud alusraam 	1	70x70	3720
IAR19	Foundation - Fundament - Fondation - Fundamenta - Fundering - Immutatud alusraam 	2	70x70	3220
IAR20	Foundation - Fundament - Fondation - Fundamenta - Fundering - Immutatud alusraam 	2	70x70	3220
IAR1	Foundation - Fundament - Fondation - Fundamenta - Fundering - Immutatud alusraam 	1	70x70	2785
IAR13	Foundation - Fundament - Fondation - Fundamenta - Fundering - Immutatud alusraam 	8	70x70	1415
IAR3	Foundation - Fundament - Fondation - Fundamenta - Fundering - Immutatud alusraam 	1	70x70	1380
IAR14	Foundation - Fundament - Fondation - Fundamenta - Fundering - Immutatud alusraam 	4	70x70	145
IAR10	Foundation - Fundament - Fondation - Fundamenta - Fundering - Immutatud alusraam 	1	45x70	5990
IAR17	Foundation - Fundament - Fondation - Fundamenta - Fundering - Immutatud alusraam 	1	45x70	5100
IAR9	Foundation - Fundament - Fondation - Fundamenta - Fundering - Immutatud alusraam 	1	45x70	4460
VT4	Mezzanine floor joists - Halbgeschoss balken - Solives de plancher mezzanine - Travi del pavimento mezzanino - Plaatduim scharnier - Vahelaetatad 	13	70x170	4280
VT1	Mezzanine floor joists - Halbgeschoss balken - Solives de plancher mezzanine - Travi del pavimento mezzanino - Plaatduim scharnier - Vahelaetatad 	9	70x170	2930
VT13	Mezzanine floor joists - Halbgeschoss balken - Solives de plancher mezzanine - Travi del pavimento mezzanino - Plaatduim scharnier - Vahelaetatad 	2	70x170	1430
VT3	Mezzanine floor joists - Halbgeschoss balken - Solives de plancher mezzanine - Travi del pavimento mezzanino - Plaatduim scharnier - Vahelaetatad 	1	70x170	1280











Pos	Mekong, Art.Nr.702241 Piece list - Stückliste - Liste des pièces - Elementi - Stuklijst - Tükítabel	Q	P (mm)	L (mm)
VT2	Mezzanine floor joists - Halbgeschoss balken - Solives de plancher mezzanine - Travi del pavimento mezzanino - Plaatduim scharnier - Vahelaetalad 	4	70x170	1130
VT15	Mezzanine floor joists - Halbgeschoss balken - Solives de plancher mezzanine - Travi del pavimento mezzanino - Plaatduim scharnier - Vahelaetalad 	1	45x120	5110
VT9	Mezzanine floor joists - Halbgeschoss balken - Solives de plancher mezzanine - Travi del pavimento mezzanino - Plaatduim scharnier - Vahelaetalad 	2	45x120	3680
VT12	Mezzanine floor joists - Halbgeschoss balken - Solives de plancher mezzanine - Travi del pavimento mezzanino - Plaatduim scharnier - Vahelaetalad 	1	45x120	3010
VT11	Mezzanine floor joists - Halbgeschoss balken - Solives de plancher mezzanine - Travi del pavimento mezzanino - Plaatduim scharnier - Vahelaetalad 	1	45x120	2030
VT10	Mezzanine floor joists - Halbgeschoss balken - Solives de plancher mezzanine - Travi del pavimento mezzanino - Plaatduim scharnier - Vahelaetalad 	1	45x120	1430
VT14	Mezzanine floor joists - Halbgeschoss balken - Solives de plancher mezzanine - Travi del pavimento mezzanino - Plaatduim scharnier - Vahelaetalad 	2	45x120	100
VT5	Mezzanine floor joists - Halbgeschoss balken - Solives de plancher mezzanine - Travi del pavimento mezzanino - Plaatduim scharnier - Vahelaetalad 	2	44x170	4050
VT8	Mezzanine floor joists - Halbgeschoss balken - Solives de plancher mezzanine - Travi del pavimento mezzanino - Plaatduim scharnier - Vahelaetalad 	1	44x170	3380
VT7	Mezzanine floor joists - Halbgeschoss balken - Solives de plancher mezzanine - Travi del pavimento mezzanino - Plaatduim scharnier - Vahelaetalad 	1	44x170	2030
VT6	Mezzanine floor joists - Halbgeschoss balken - Solives de plancher mezzanine - Travi del pavimento mezzanino - Plaatduim scharnier - Vahelaetalad 	2	44x170	1430
VT17	Mezzanine floor joists - Halbgeschoss balken - Solives de plancher mezzanine - Travi del pavimento mezzanino - Plaatduim scharnier - Vahelaetalad 	1	44x170	300
VT16	Mezzanine floor joists - Halbgeschoss balken - Solives de plancher mezzanine - Travi del pavimento mezzanino - Plaatduim scharnier - Vahelaetalad 	2	44x170	100
SR4	Rafter - Dachsparren - Chevron - Trave - Dak spar - Sarikas 	14	70x190	5135
SR2	Rafter - Dachsparren - Chevron - Trave - Dak spar - Sarikas 	12	70x190	3762
SR3	Rafter - Dachsparren - Chevron - Trave - Dak spar - Sarikas 	28	70x190	3302
SR1	Rafter - Dachsparren - Chevron - Trave - Dak spar - Sarikas 	11	70x190	3127
SR5	Rafter - Dachsparren - Chevron - Trave - Dak spar - Sarikas 	3	70x190	1755
SR6	Rafter - Dachsparren - Chevron - Trave - Dak spar - Sarikas 	1	70x190	1334
STP	Ceiling boards - Deckenbrett - Voliges sous plafond - Tavole per piano soffitto - Dakhout - Laelaud 	40	111x15	5106
STP	Ceiling boards - Deckenbrett - Voliges sous plafond - Tavole per piano soffitto - Dakhout - Laelaud 	53	111x15	3676
STP	Ceiling boards - Deckenbrett - Voliges sous plafond - Tavole per piano soffitto - Dakhout - Laelaud 	26	111x15	3006
STP	Ceiling boards - Deckenbrett - Voliges sous plafond - Tavole per piano soffitto - Dakhout - Laelaud 	26	111x15	2026

Pos	Mekong, Art.Nr.702241 Piece list - Stückliste - Liste des pièces - Elementi - Stuklijst - Tükítabel	Q	P (mm)	L (mm)
STP	Ceiling boards - Deckenbrett - Voliges sous plafond - Tavole per piano soffitto - Dakhout - Laelaud 	53	111x15	1426
HLL	Floor boards - Fussbodenbretter - Lame de plancher - Pavimento - Vloerhout - Pörandalaud 		137x28	779.4
RB	Roof boards - Dachbretter - Voliges - Perlina per tetto - Dakhout - Katuselaud 	79	90x18	5585
RB	Roof boards - Dachbretter - Voliges - Perlina per tetto - Dakhout - Katuselaud 	15	90x18	5550
RB	Roof boards - Dachbretter - Voliges - Perlina per tetto - Dakhout - Katuselaud 	79	90x18	5515
RB	Roof boards - Dachbretter - Voliges - Perlina per tetto - Dakhout - Katuselaud 	20	90x18	324.4
RB	Roof boards - Dachbretter - Voliges - Perlina per tetto - Dakhout - Katuselaud 	15	90x18	3205
RB	Roof boards - Dachbretter - Voliges - Perlina per tetto - Dakhout - Katuselaud 	20	90x18	2676
RB	Roof boards - Dachbretter - Voliges - Perlina per tetto - Dakhout - Katuselaud 	15	90x18	2645
SV2	Terrace boards - Terrassenbretter - Plancher de terrasse - Piattaforme terrazzo - Terrasvloer - Terrassilaud 	12	120x28	3469
SV2	Terrace boards - Terrassenbretter - Plancher de terrasse - Piattaforme terrazzo - Terrasvloer - Terrassilaud 	42	120x28	2750
SV2	Terrace boards - Terrassenbretter - Plancher de terrasse - Piattaforme terrazzo - Terrasvloer - Terrassilaud 	12	120x28	2351
SV2	Terrace boards - Terrassenbretter - Plancher de terrasse - Piattaforme terrazzo - Terrasvloer - Terrassilaud 	39	120x28	1400
FL	Floor fillet - Fussbodenleiste - Corniere de finition du plancher - Finitura per pavimento (battisco pa) - Vloerafwerklijs - Pörandaliist 		18x18	100
LL	Ceiling fillet - Deckeleiste - Profil de finition sous plafond - Massello per soffitto - Dak afdeklijs - Laeliist 		15x40	85
DPL-2	Roofing felt fillet - Dachpappenleiste - Baguette de fixation du feutre bitumeux - Asse per fissaggio guaina bituminosa - Afdeklijs asfaltpapier - Kald-katusepapiiist 	4	18x58	5210
DPL	Roofing felt fillet - Dachpappenleiste - Baguette de fixation du feutre bitumeux - Asse per fissaggio guaina bituminosa - Afdeklijs asfaltpapier - Katusepapiiist 	1	18x58	1297
DPL	Roofing felt fillet - Dachpappenleiste - Baguette de fixation du feutre bitumeux - Asse per fissaggio guaina bituminosa - Afdeklijs asfaltpapier - Katusepapiiist 	1	18x58	1471
DPL	Roofing felt fillet - Dachpappenleiste - Baguette de fixation du feutre bitumeux - Asse per fissaggio guaina bituminosa - Afdeklijs asfaltpapier - Katusepapiiist 	1	18x58	1779
DPL	Roofing felt fillet - Dachpappenleiste - Baguette de fixation du feutre bitumeux - Asse per fissaggio guaina bituminosa - Afdeklijs asfaltpapier - Katusepapiiist 	1	18x58	3151
DPL	Roofing felt fillet - Dachpappenleiste - Baguette de fixation du feutre bitumeux - Asse per fissaggio guaina bituminosa - Afdeklijs asfaltpapier - Katusepapiiist 	2	18x58	3327
DPL	Roofing felt fillet - Dachpappenleiste - Baguette de fixation du feutre bitumeux - Asse per fissaggio guaina bituminosa - Afdeklijs asfaltpapier - Katusepapiiist 	1	18x58	3822
DPL	Roofing felt fillet - Dachpappenleiste - Baguette de fixation du feutre bitumeux - Asse per fissaggio guaina bituminosa - Afdeklijs asfaltpapier - Katusepapiiist	1	18x58	5195

Pos	Mekong, Art.Nr.702241 Piece list - Stückliste - Liste des pièces - Elementi - Stuklijst - Tükítabel	Q	P (mm)	L (mm)
DPL	Roofing felt fillet - Dachpappenleiste - Baguette de fixation du feutre bitumeux - Asse per fissaggio guaina bituminosa - Afdekljst asfaltpapier - Kafusepapiiist 	2	18x58	5528
M1	Treaded rod m12 - Gewindestange m12 - Tige filetée m12 - Barra filettata passo m12 - Draadstang 12m - Keermelatt 	2		100
M2	Treaded rod m12 - Gewindestange m12 - Tige filetée m12 - Barra filettata passo m12 - Draadstang 12m - Keermelatt 	2		240
M3	Treaded rod m12 - Gewindestange m12 - Tige filetée m12 - Barra filettata passo m12 - Draadstang 12m - Keermelatt 	3		260
M4	Treaded rod m12 - Gewindestange m12 - Tige filetée m12 - Barra filettata passo m12 - Draadstang 12m - Keermelatt 	1		320
M5	Treaded rod m12 - Gewindestange m12 - Tige filetée m12 - Barra filettata passo m12 - Draadstang 12m - Keermelatt 	2		640
M6	Treaded rod m12 - Gewindestange m12 - Tige filetée m12 - Barra filettata passo m12 - Draadstang 12m - Keermelatt 	1		830
M7	Treaded rod m12 - Gewindestange m12 - Tige filetée m12 - Barra filettata passo m12 - Draadstang 12m - Keermelatt 	15		2000
LPL	Fixing fillet - Fixierungsleiste - Profil de fixation - Massello di fissaggio - Bevestiging lijstwerk - Tenderliist 	3	18x70	791
LPL	Fixing fillet - Fixierungsleiste - Profil de fixation - Massello di fissaggio - Bevestiging lijstwerk - Tenderliist 	6	18x70	2000
P	Post - Pfosten - Poteau - Piede registrabile - Stijl - Post 	3	120x120	1727
TB	Fascia board - Traufbrett - Bandeau de toit - Finitura lati tetto - Gevellijst - Räästalaud 	3	18x90	236
TB	Fascia board - Traufbrett - Bandeau de toit - Finitura lati tetto - Gevellijst - Räästalaud 	1	18x90	5250
TB	Fascia board - Traufbrett - Bandeau de toit - Finitura lati tetto - Gevellijst - Räästalaud 	2	18x90	5515
TB	Fascia board - Traufbrett - Bandeau de toit - Finitura lati tetto - Gevellijst - Räästalaud 	2	18x90	5585
TB	Fascia board - Traufbrett - Bandeau de toit - Finitura lati tetto - Gevellijst - Räästalaud 	1	18x90	5850
TB	Fascia board - Traufbrett - Bandeau de toit - Finitura lati tetto - Gevellijst - Räästalaud 	1	18x90	5920
TB	Fascia board - Traufbrett - Bandeau de toit - Finitura lati tetto - Gevellijst - Räästalaud 	3	18x120	236
TB	Fascia board - Traufbrett - Bandeau de toit - Finitura lati tetto - Gevellijst - Räästalaud 	2	18x120	5250
TB	Fascia board - Traufbrett - Bandeau de toit - Finitura lati tetto - Gevellijst - Räästalaud 	4	18x120	5515
TB	Fascia board - Traufbrett - Bandeau de toit - Finitura lati tetto - Gevellijst - Räästalaud 	4	18x120	5585
TB	Fascia board - Traufbrett - Bandeau de toit - Finitura lati tetto - Gevellijst - Räästalaud 	2	18x120	5850
TB	Fascia board - Traufbrett - Bandeau de toit - Finitura lati tetto - Gevellijst - Räästalaud 	2	18x120	5920

Pos	Mekong, Art.Nr.702241 Piece list - Stückliste - Liste des pièces - Elementi - Stuklijst - Tükítabel	Q	P (mm)	L (mm)
TBE12	Fixing fillet - Fixierungsleiste - Profil de fixation - Massello di fissaggio - Bevestiging lijstwerk - Tenderliist 	3	28x34	125
TBE6	Fixing fillet - Fixierungsleiste - Profil de fixation - Massello di fissaggio - Bevestiging lijstwerk - Tenderliist 	10	28x34	650
TBE6	Fixing fillet - Fixierungsleiste - Profil de fixation - Massello di fissaggio - Bevestiging lijstwerk - Tenderliist 	4	28x34	786
TBE6	Fixing fillet - Fixierungsleiste - Profil de fixation - Massello di fissaggio - Bevestiging lijstwerk - Tenderliist 	8	28x34	916
TBE6	Fixing fillet - Fixierungsleiste - Profil de fixation - Massello di fissaggio - Bevestiging lijstwerk - Tenderliist 	8	28x34	1600
TBE6	Fixing fillet - Fixierungsleiste - Profil de fixation - Massello di fissaggio - Bevestiging lijstwerk - Tenderliist 	8	28x34	1930
TBE6	Fixing fillet - Fixierungsleiste - Profil de fixation - Massello di fissaggio - Bevestiging lijstwerk - Tenderliist 	2	28x34	2000
GL2	Gable moulding - Giebelleiste - Planche de rive - Finitura per frontale e retro del tetto - Gevellijst - Viilulaud 	1	18x120	1410
GL2	Gable moulding - Giebelleiste - Planche de rive - Finitura per frontale e retro del tetto - Gevellijst - Viilulaud 	1	18x120	1801
GL2	Gable moulding - Giebelleiste - Planche de rive - Finitura per frontale e retro del tetto - Gevellijst - Viilulaud 	1	18x120	3173
GL2	Gable moulding - Giebelleiste - Planche de rive - Finitura per frontale e retro del tetto - Gevellijst - Viilulaud 	2	18x120	3348
GL2	Gable moulding - Giebelleiste - Planche de rive - Finitura per frontale e retro del tetto - Gevellijst - Viilulaud 	1	18x120	3844
GL2	Gable moulding - Giebelleiste - Planche de rive - Finitura per frontale e retro del tetto - Gevellijst - Viilulaud 	1	18x120	5218
GL2	Gable moulding - Giebelleiste - Planche de rive - Finitura per frontale e retro del tetto - Gevellijst - Viilulaud 	1	18x90	1405
GL2	Gable moulding - Giebelleiste - Planche de rive - Finitura per frontale e retro del tetto - Gevellijst - Viilulaud 	1	18x90	1795
GL2	Gable moulding - Giebelleiste - Planche de rive - Finitura per frontale e retro del tetto - Gevellijst - Viilulaud 	1	18x90	3167
GL2	Gable moulding - Giebelleiste - Planche de rive - Finitura per frontale e retro del tetto - Gevellijst - Viilulaud 	2	18x90	3343
GL2	Gable moulding - Giebelleiste - Planche de rive - Finitura per frontale e retro del tetto - Gevellijst - Viilulaud 	1	18x90	3838
GL2	Gable moulding - Giebelleiste - Planche de rive - Finitura per frontale e retro del tetto - Gevellijst - Viilulaud 	1	18x90	5212
GL	Gable moulding - Giebelleiste - Planche de rive - Finitura per frontale e retro del tetto - Gevellijst - Viilulaud 	1	18x120	1410
GL	Gable moulding - Giebelleiste - Planche de rive - Finitura per frontale e retro del tetto - Gevellijst - Viilulaud 	1	18x120	1801
GL	Gable moulding - Giebelleiste - Planche de rive - Finitura per frontale e retro del tetto - Gevellijst - Viilulaud 	1	18x120	3173
GL	Gable moulding - Giebelleiste - Planche de rive - Finitura per frontale e retro del tetto - Gevellijst - Viilulaud 	2	18x120	3348

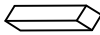
Pos	Mekong, Art.Nr.702241 Piece list - Stückliste - Liste des pièces - Elementi - Stuklijst - Tükítabel	Q	P (mm)	L (mm)
GL	Gable moulding - Giebelleiste - Planche de rive - Finitura per frontale e retro del tetto - Gevellijst - Viilulaud 	1	18x120	3844
GL	Gable moulding - Giebelleiste - Planche de rive - Finitura per frontale e retro del tetto - Gevellijst - Viilulaud 	1	18x120	5218
LD1	Lid for treaded rod hole - Abdeckung für gewindestangenöffnung - Couvercle pour accés réglagé tige filetée - Copeerchio per foro barra filettata - Afdekprofiel voor draadstang - Kaas keermelatilavale 	10		
KL4	Lengthening bolt for treaded rod - Verlängerungsmutter für gewindestange - Manchon de raccordement de tige filetée - Bullone per barra filettata passo - Extensie moer voor draadstang - Jätkumutter keermelatilavale 	15		
KL1	Drive nut treaded rod - Einschlagmutter für gewindestange - Écrou a frapper pour tige filitée - Dado guida per barra filettata - Aandrijfmoer / aanslagmoer voor draadstang - Löökmutter keermelatilavale 	11		
KL2	Nut for treaded rod - Mutter für gewindestange - Écrou pour tige filetée - Dado per barra filettata - Moer voor draadstang - Mutter keermelatilavale 	11		
KL3	Plain washer treaded rod - Unterlegscheibe für gewindestange - Rondelle plate pour tige filetée - Rondella per barra filettata - Sluistring voor draadeind - Seib keermelatilavale 	11		
HS83	Screw for fixing fillet of door and window - Schrauben für fixierungsleiste - Vis pour profil vertical de fixation pour ouvertures des fenetres et portes - Viti per massello di fissaggio - Schroeven voor bevestiging van deur en raam lijsten - Kruvi tenderliistuudele 	36	3.5x50	
HS25	Screw for floor - Schrauben für fussbodenbretter - Vis pour plancher - Viti per le perline del pavimento - Schroef voor vloerhout - Kruvi põrandale 	2300	3.5x50	
HS84	Screw for fixing fillet of door and window - Schrauben für fixierungsleiste - Vis pour profil vertical de fixation pour ouvertures des fenetres et portes - Viti per massello di fissaggio - Schroeven voor bevestiging van deur en raam lijsten - Kruvi tenderliistuudele 	200	3.5x50	
HS16	Screw for gable moulding - Schrauben für giebelleiste - Vis pour fixation planche de rive - Vite per fissare finitura davanti e dietro del tetto - Schroef voor gevellijst - Kruvi viilulauale 	360	3.5x50	
HS37	Screw for post - Schrauben für pfosten - Vis de fixation des poteaux - Viti per inviare - Schroef voor stijlen - Kruvi postile 	12	4.5x80	
HS32	Screw for fascia boards - Schrauben für traufbretter - Vis pour fixation bandeau de toit - Viti x striscia del tetto - Schroef voor gevellijst - Kruvi räästalauale 	327	4x40	
HS40	Screw for 1. wall beam - Schraube für 1. bohlenreihe - Vis de fixations 1ere rangée de madriers avec poutrelles de fondations - Vite fissaggio alle fondamenta - Schroef voor 1 wandbalk - Kruvi poollauale 	33	5x120	
HS39	Screw for foundation - Schrauben zur befestigung fundament - Vis de fixations des poutrelles de fondations - Viti x fondamenta - Schroef voor fundering - Kruvi alusraamile 	150	5x120	
HS42	Screw for gable - Schrauben für giebel - Vis pour fixation des pignons - Viti per timpano - Schroef voor gevelpunt - Kruvi viilude kinnitamiseks 	37	5x120	
HS120	Screw for beam - Schrauben zur befestigung dachsparren - Vis pour solive - Viti per perline - Schroef voor balk (gording) - Kruvi talale 	132	5x120	
HS46	Screw for pos. 013; 033-035; 068-070; 086-088 - Schrauben für pos. 013; 033-035; 068-070; 086-088 - Vis pour pos. 013; 033-035; 068-070; 086-088 - Viti per fissare elemento vedi figura in pos. n. 013; 033-035; 068-070; 086-088 - Schroef voor pos. 013; 033-035; 068-070; 086-088 - Kruvi pos. 013; 033-035; 068-070; 086-088 	116	5x90	
HS90	Screw for rafter - Schrauben für dachsparren - Vis pour chevron - Vite per trave - Schroef voor dakspar - Kruvi sarikatele 	146	5x90	
HS90	Screw for loft support - Schraube für dachbefestigung - Vis pour cornière de renfort de fixation - Viti per supporto del soppalco - Schroef voor dakbevestiging - Kruvi vahelae kandurliistuule 	138	5x90	
HS90	Screw for beam - Schrauben zur befestigung dachsparren - Vis pour solive - Viti per perline - Schroef voor balk (gording) - Kruvi talale 	92	5x90	
HS48	Screw for pos. 012; 030-032; 067; 084-085 - Schrauben für pos. 012; 030-032; 067; 084-085 - Vis pour pos. 012; 030-032; 067; 084-085 - Viti per fissare elemento vedi figura in pos.n. 012; 030-032; 067; 084-085 - Schroef voor pos. 012; 030-032; 067; 084-085 - Kruvi pos. 012; 030-032; 067; 084-085 	116	6x180	
HS15	Screw for wall details - Schraube für wand details - Vis pour mur details - Viti per elementi della porta - Schroef voor wand details - Kruvi seinadetailidele 	20	6x180	

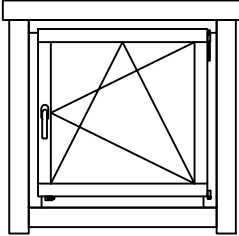
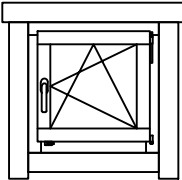
Pos	Mekong, Art.Nr.702241 Piece list - Stückliste - Liste des pièces - Elementi - Stuklijst - Tükítabel	Q	P (mm)	L (mm)
HS49	Screw for post height adjustment - Schrauben für regulierungsschraube für pfosten - Vis de fixation de support réglable de poteau - Viti per fissare ed aggiustare l'altezza del palo verticale - Schroef voor hoogte instelling stijlen - Kruvi vajumispoldile		24	6x50
HS15	Screw for wall details - Schraube für wand details - Vis pour mur details - Viti per elementi della porta - Schroef voor wand details - Kruvi seinadetailidele		276	8x220
MS	Screw for doorstep - Schrauben für swelle - Vis pour fixation barre de seuil - Vite per soglia della porta - Schroef voor deurdorpel - Kruvi lävepakule		11	4.5x65
SH70	Hammer block - Schlagholz - Calle de frappe - Blocco di legno da usare come cuscinetto quando si usa il martello - Slagklos - Löögiklots		2	
NFD	Zn nail for roofing felt fillet - Zn nägel für dachpappenleiste - Pointe pour baguette de fixation feutre bitumeux - Chiodi x carta bituminosa x tetto - Spijker(nagel) voor asfaltpapier afdekljst - Papiliistunael		153	2x40
NF3	Zn nail for terrace - Zn nägel für terrassenbretter - Pointe pour plancher de terrasse - Chiodo zincato per terrazza - Spijker(nagel) voor terrasvloer - Nael terrassilauale		1230	2.1x50
NFF	Zn nail for floor fillet - Zn nägel für fussbodenleiste - Pointe pour corniere de finition du plancher - Chiodi x fissaggio pavimento - Spijker(nagel) voor vloer afdekljst - Nael põrandaliistule		390	1.4x40
NF2	Zn nail for roof - Zn nägel für dachbretter - Pointe pour fixation voliges de toit - Chiodi x perline tetto - Spijker(nagel) voor dakhout - Nael katuselauale		2985	2.1x50
NF2	Zn nail for ceiling boards - Zn nägel für deckenbretter - Clous pour voliges sous plafonds - Chiodo per il tavolo del soffitto - Spijkers voor plafondplaat - Nael laelauale		1395	2.1x50
ORZ	Montage set for doors windows - Montage-set für türen und fenster - Jeu de montage portes et fenetres - Set di assemblaggio per porte e finestre - Montage set voor deur en raam - Orthez akna ja ukse montaaživahendid		1	
SP1	Hidden fixing - Holzdübel - Tourillon bois - Fissaggio a scomparsa - Verloren kop spijker - Salapulk		138	
RFP	Post height adjustment - Pfostenträger verstellbar - Support réglable de poteau - Piede registrabile in altezza - Stelschroef voor stijlpot - Vajumispolt		3	
TPP	Stair - Treppe - Escalier - Scala - Trap - Trepp		1	
2+ A.0P.K	Window - Fenster - Fenetre - Finestra - Raam - Aken 916x916 		1	
2+ A.0P.cK	Window - Fenster - Fenetre - Finestra - Raam - Aken 650x650 		2	

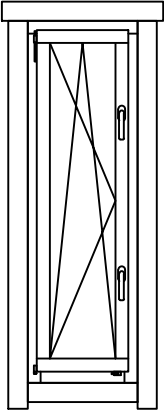
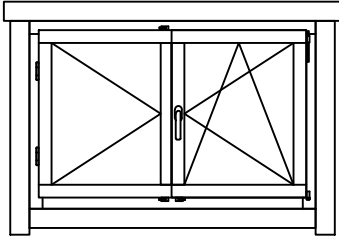
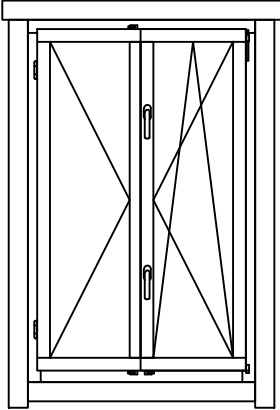
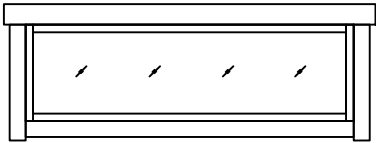
Pos	Mekong, Art.Nr.702241 Piece list - Stückliste - Liste des pièces - Elementi - Stuklijst - Tükítabel	Q	P (mm)	L (mm)
2+ A.0V.bK	Window - Fenster - Fenetre - Finestra - Raam - Aken 552x1729 	1		
2+ TA.0P.K	Window - Fenster - Fenetre - Finestra - Raam - Aken 1374x916 	5		
2+ TA.0P.bK	Window - Fenster - Fenetre - Finestra - Raam - Aken 1100x1729 	3		
	Window - Fenster - Fenetre - Finestra - Raam - Aken 1840x650 	3		

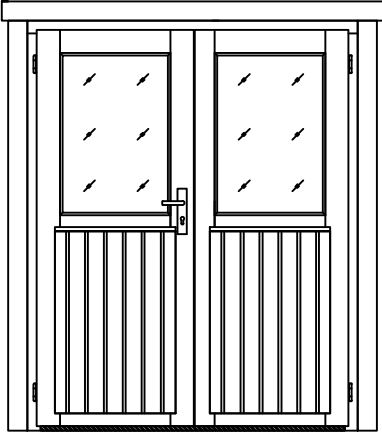
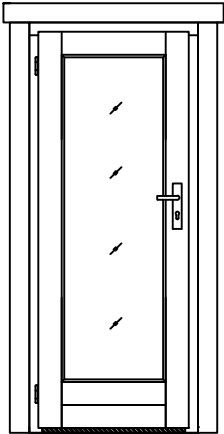
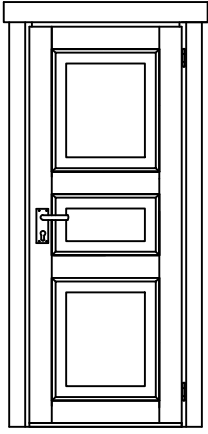
Pos	Mekong, Art.Nr.702241 Piece list - Stückliste - Liste des pièces - Elementi - Stuklijst - Tükitabel	Q	P (mm)	L (mm)
2+ TU.20V.bK	Door - Tür - Porte - Porte - Deur - Uks 1580x2000 	1		
2+ U.10V.bK	Door - Tür - Porte - Porte - Deur - Uks 827x2000 	1		
U.3TP.b	Door - Tür - Porte - Porte - Deur - Uks 827x2000 +LPL 	2		

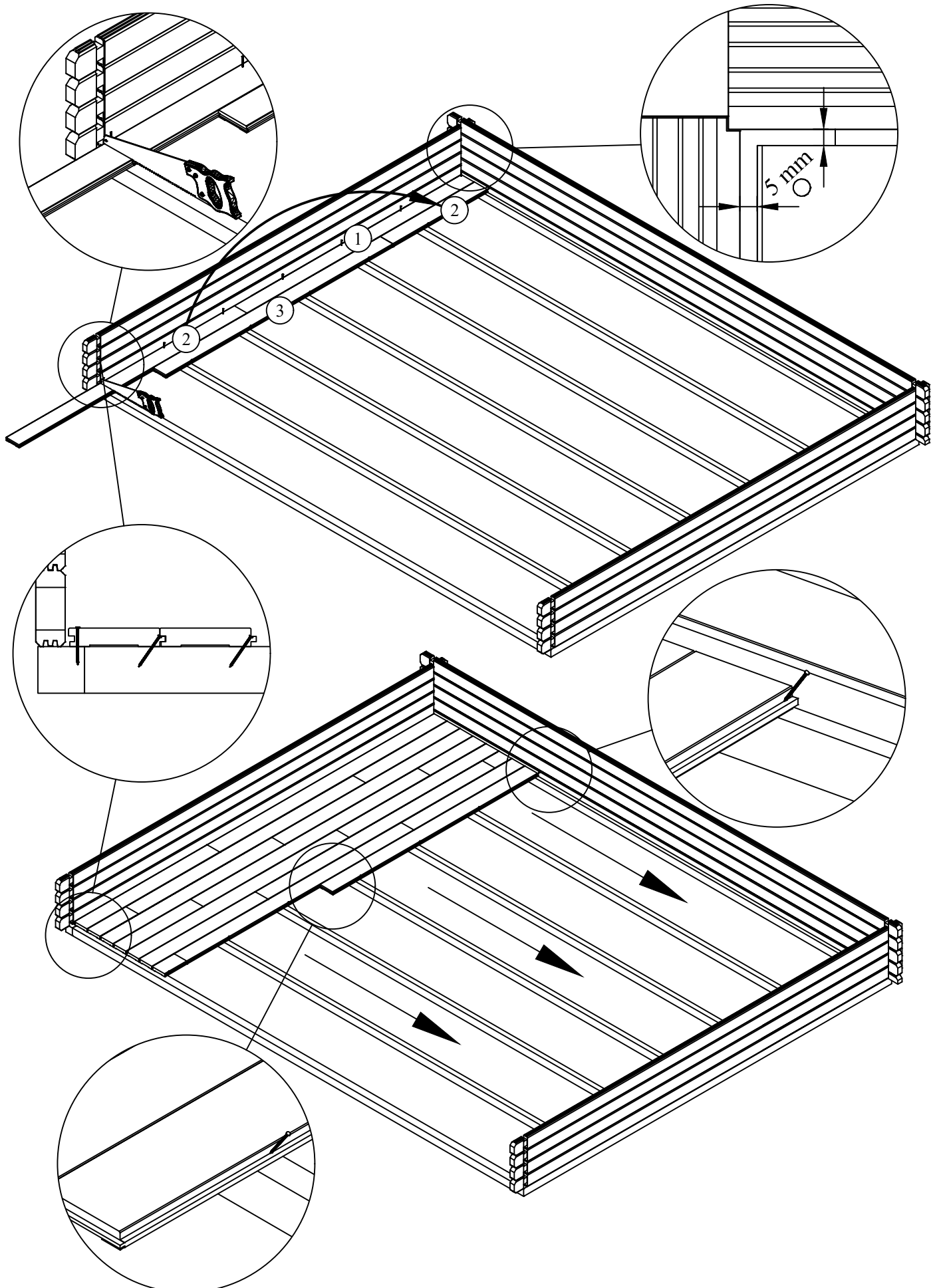

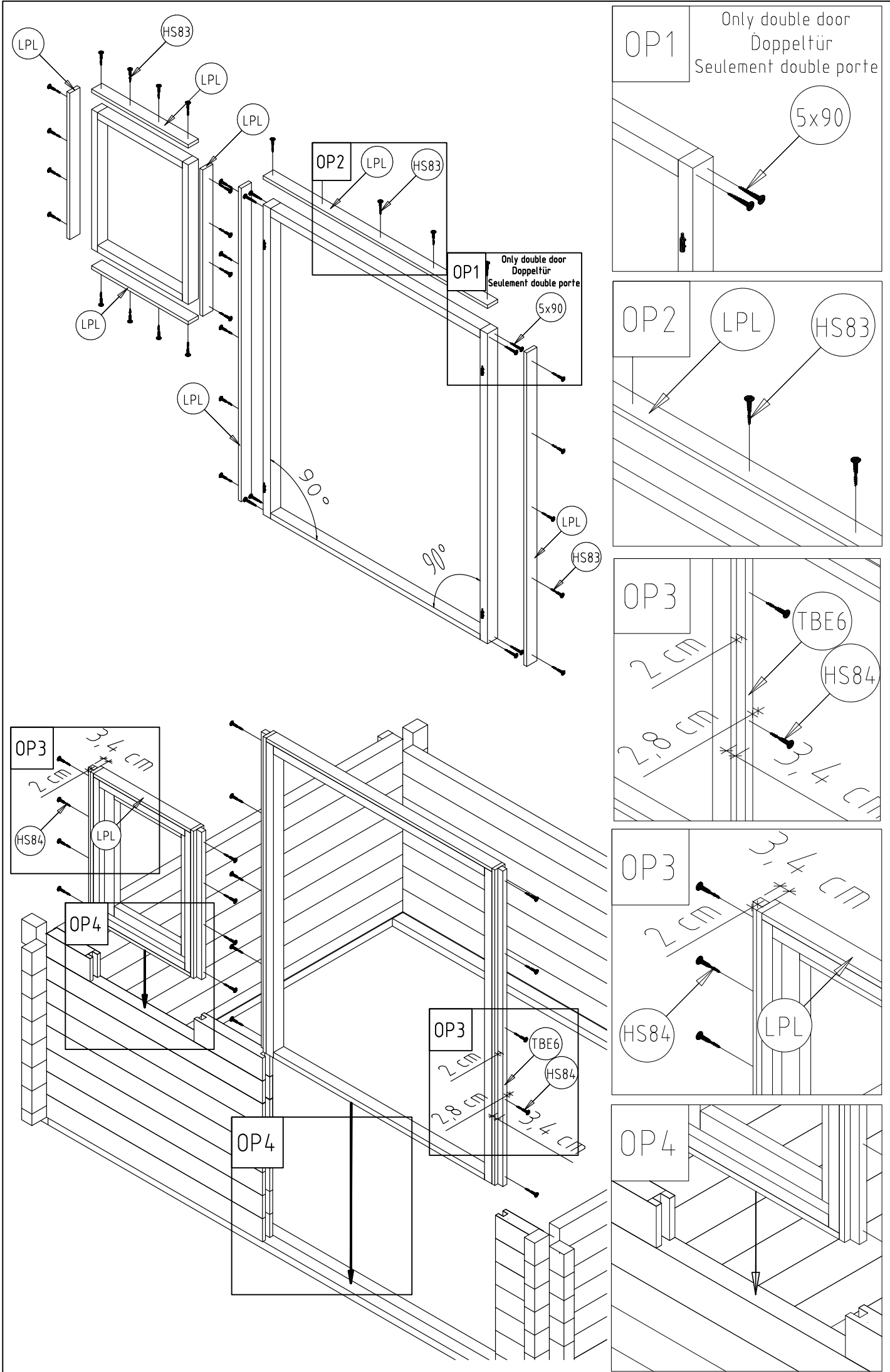

OP1 Only double door
Doppeltür
Seulement double porte

