

Malmö
Art.No. 7015041

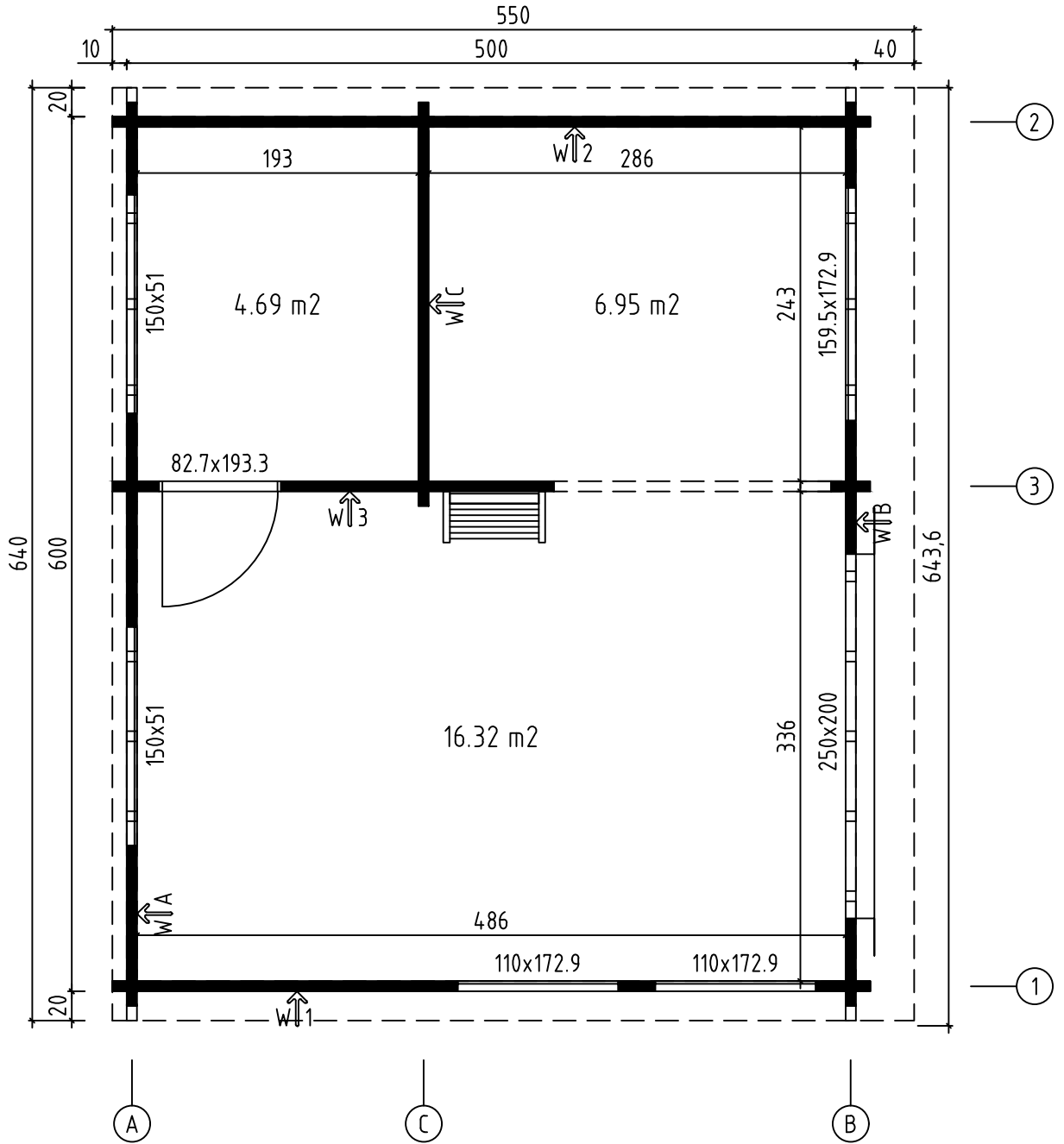

Groundplan - Grundplan - Plan de masse - Planimetria - Plattegrond - Põhiplaan



Malmö, Art.No.7015041

Grundplan - Grundplan - Plan de masse - Planimetria - Plattegrond -
Põhiplaan

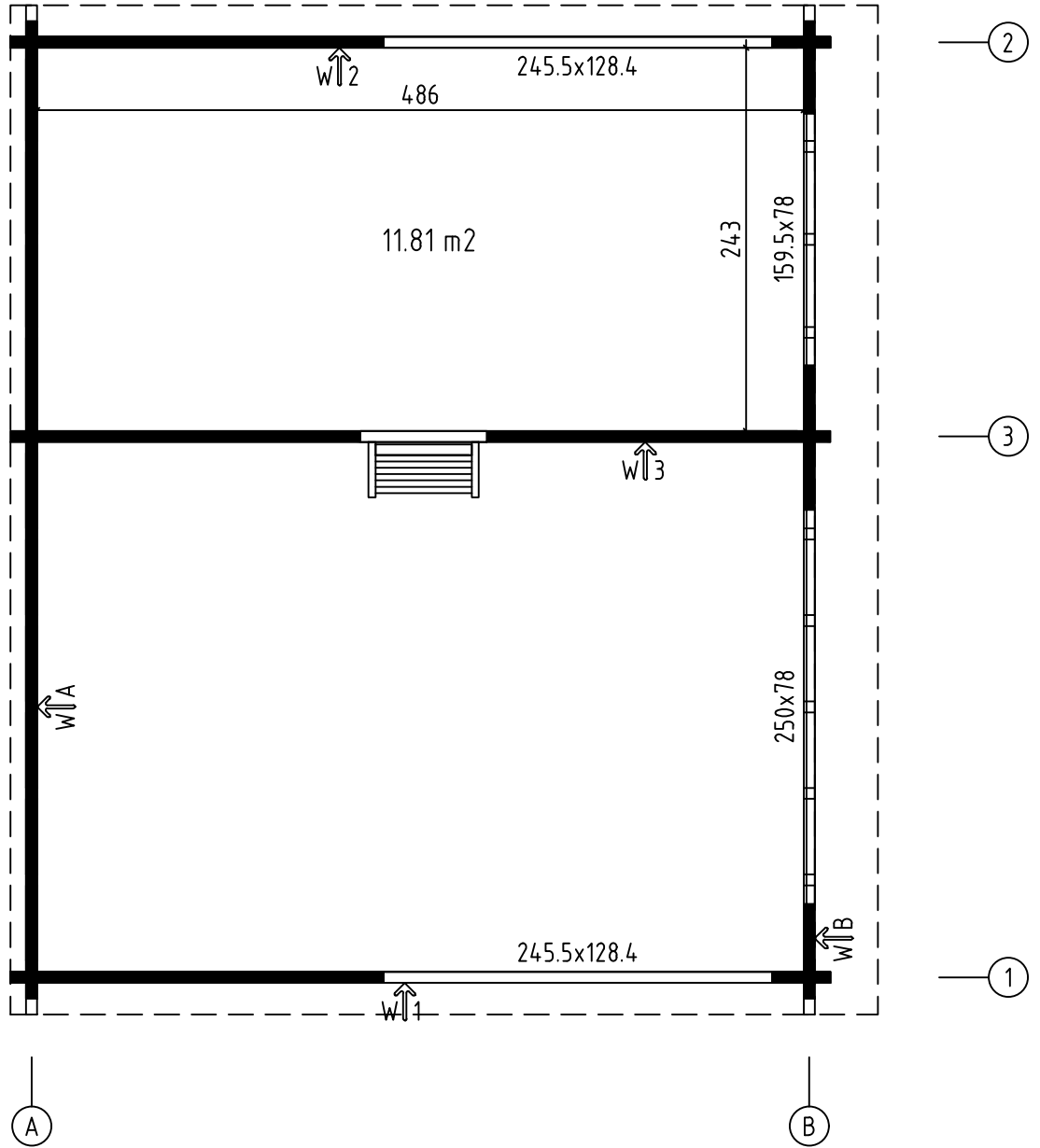

Foundation - Fundament - Fondation - Fondamenta - Fundering - Immutatud alusraam

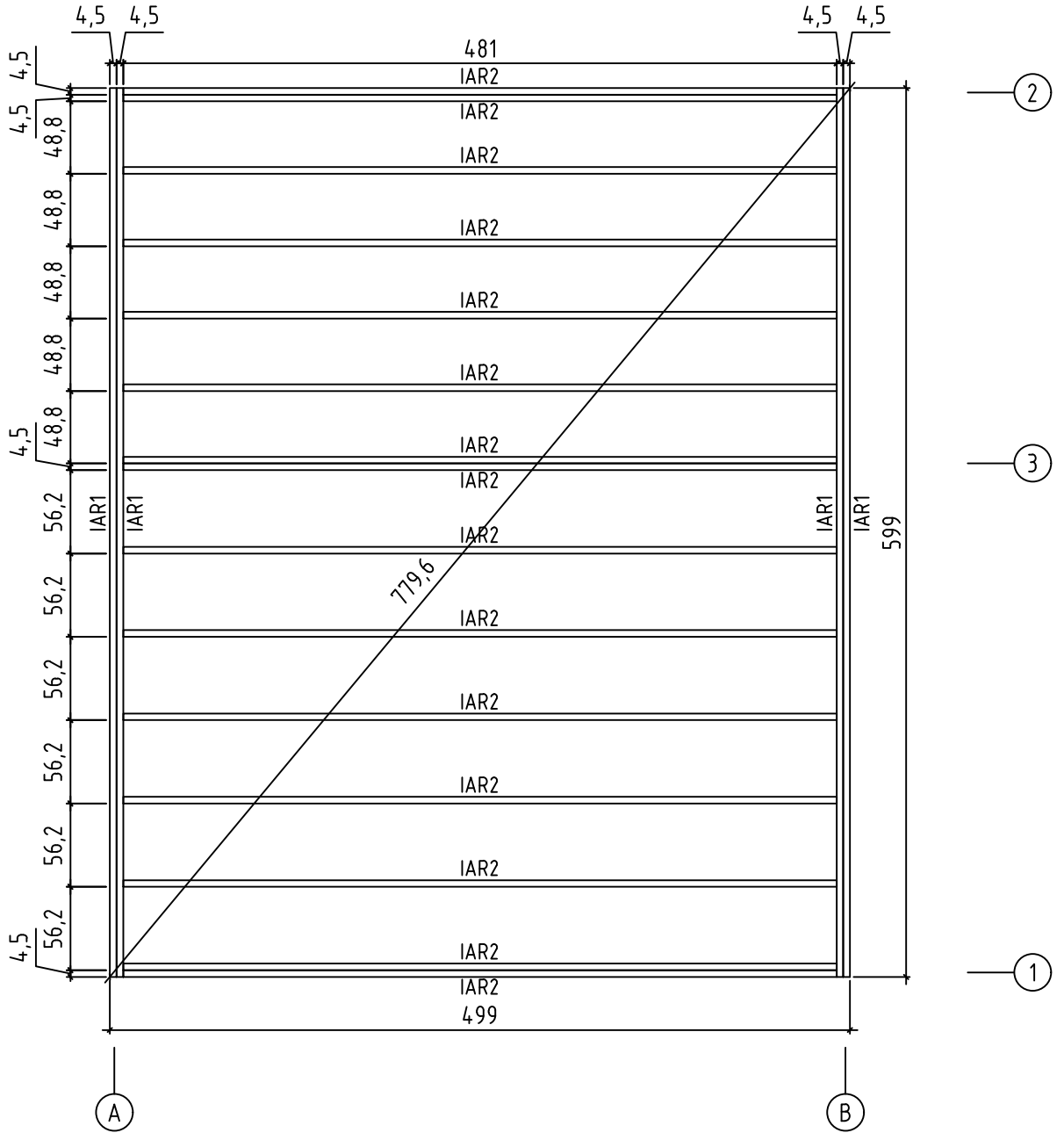

Rafters plan - Dachsparren - Plan de chevron - Piano di travi - Dak spar
constructie plattegrond - Sarikaplaan

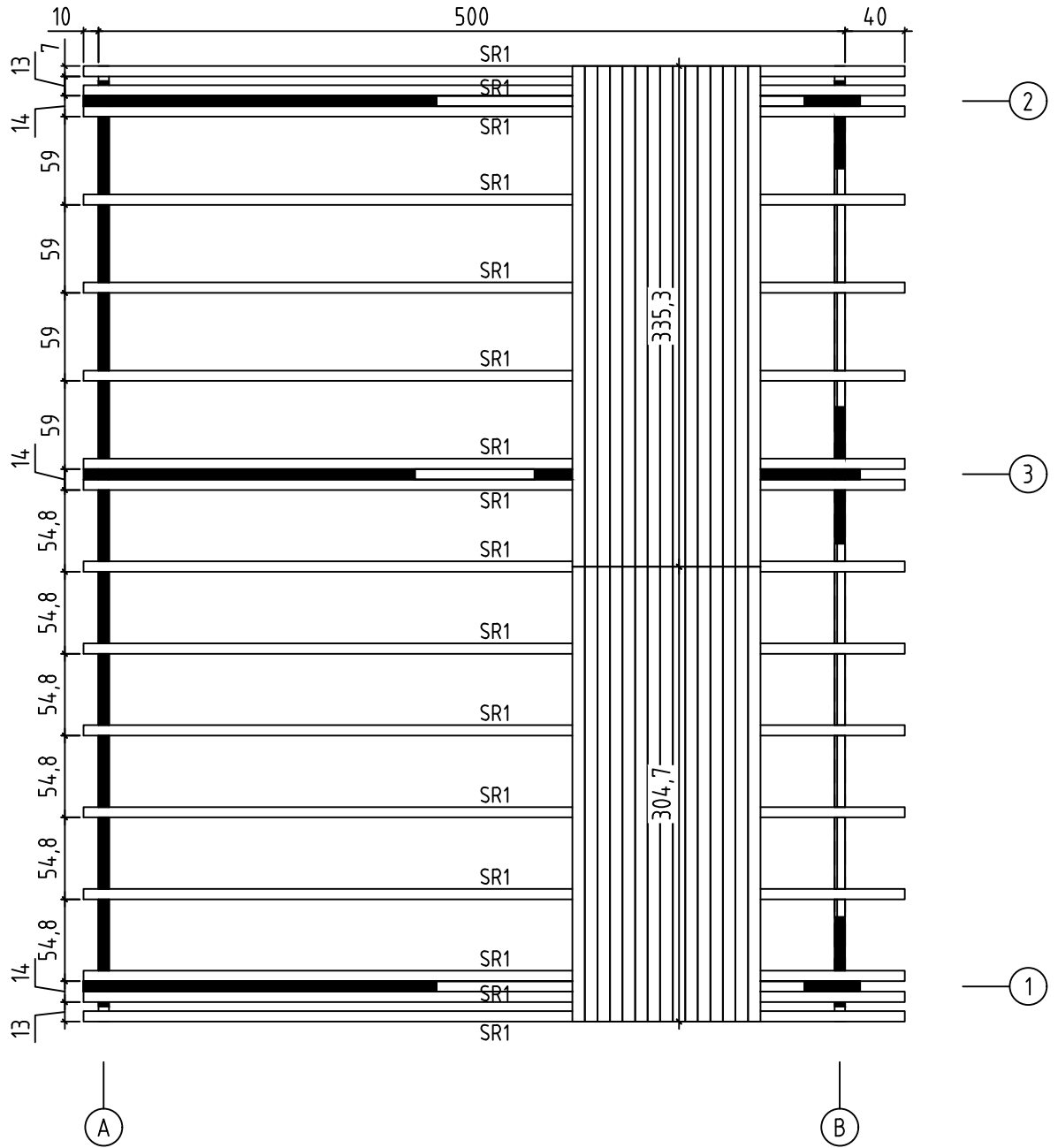

Malmö, Art.No.7015041

Floor boards - Fussbodenbretter - Plan pose plancher - Pavimento - Vloerhout
- Põrandalaudis

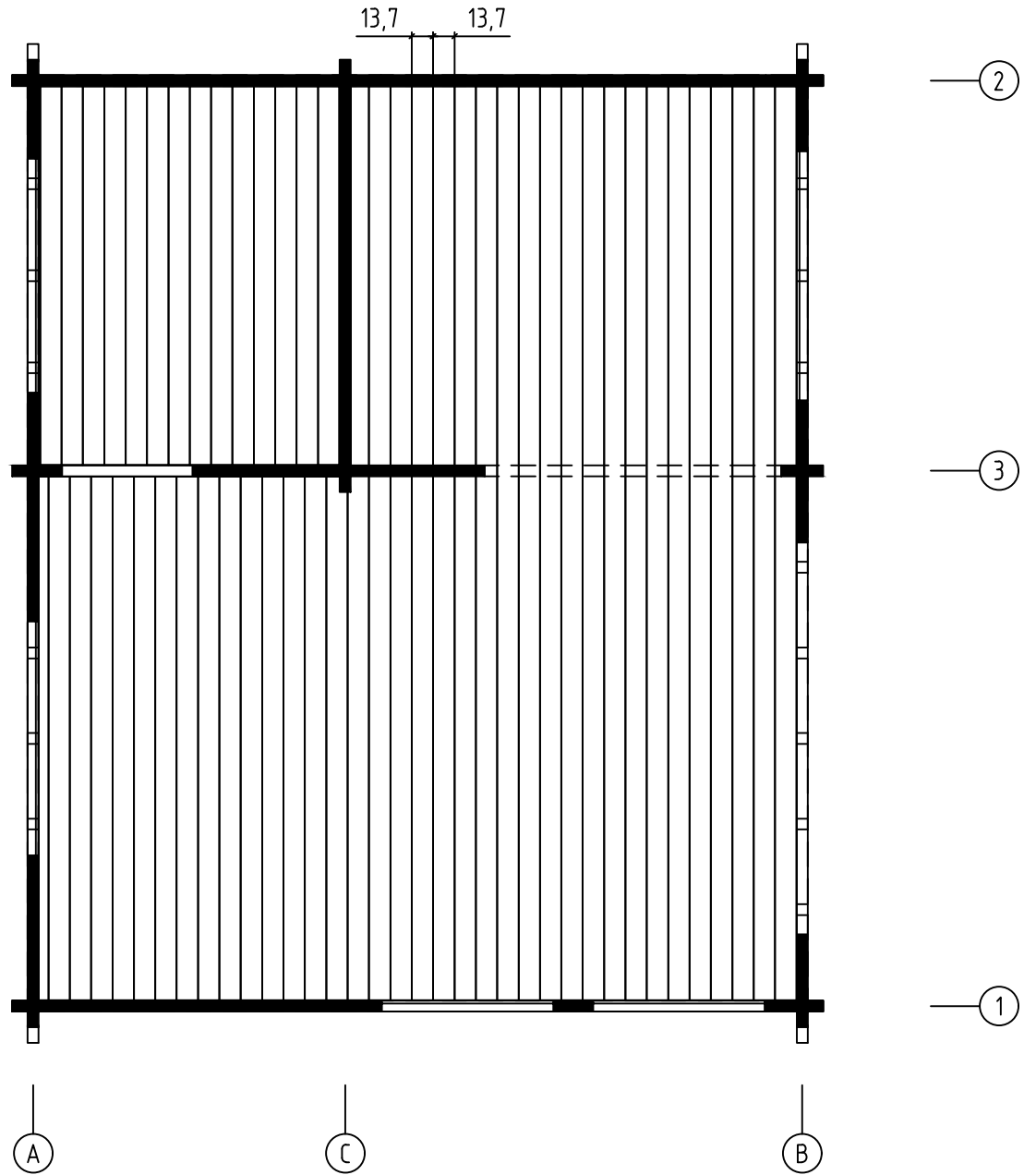

Malmö, Art.No.7015041

Floor boards - Fussbodenbretter - Plan pose plancher - Pavimento - Vloerhout
- Põrandalaudis

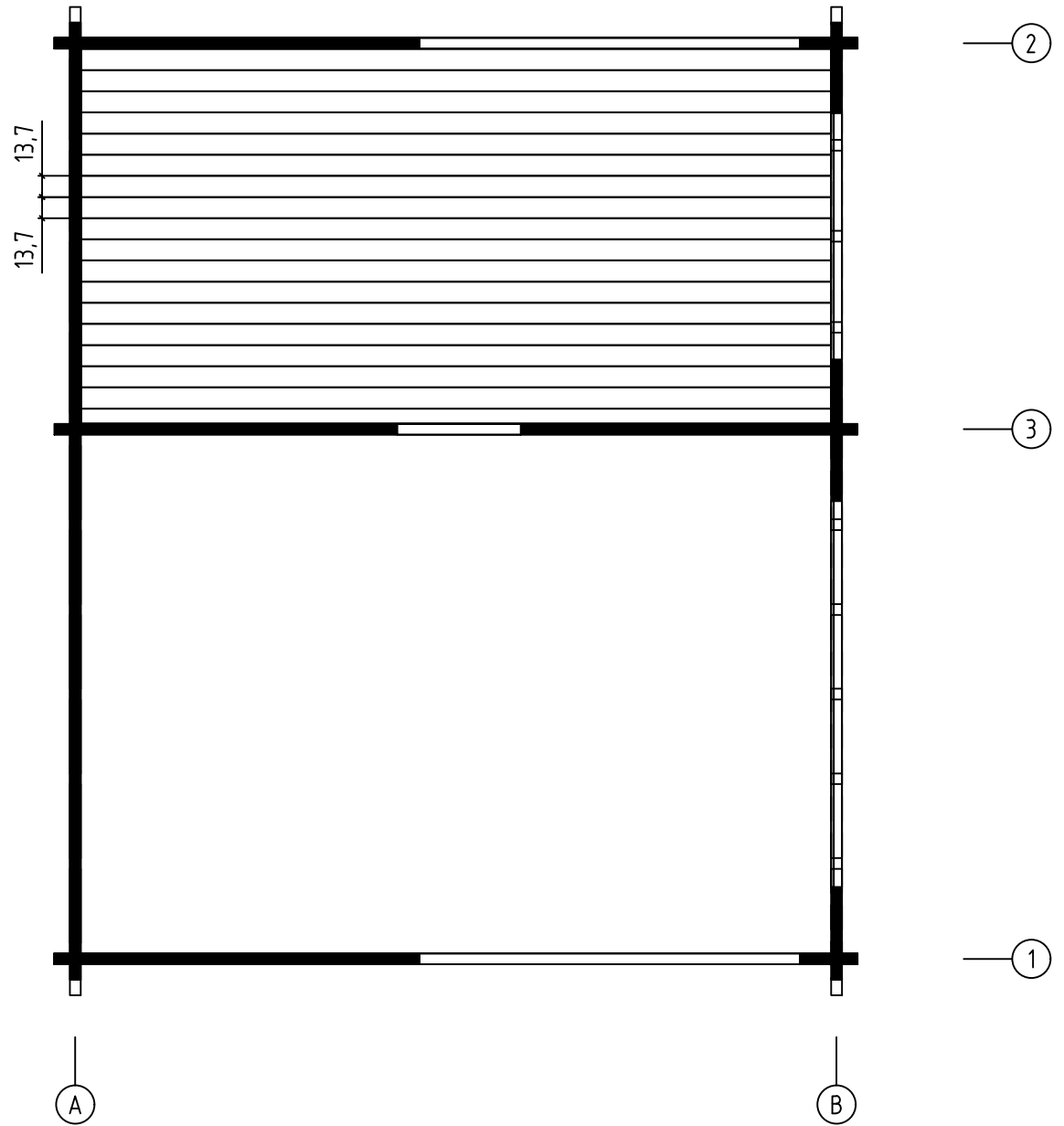

Malmö, Art.No.7015041

Ceiling boards - Deckenbrett - Voliges sous plafond - Tavole per piano soffitto
- Dakhout - Laelaud

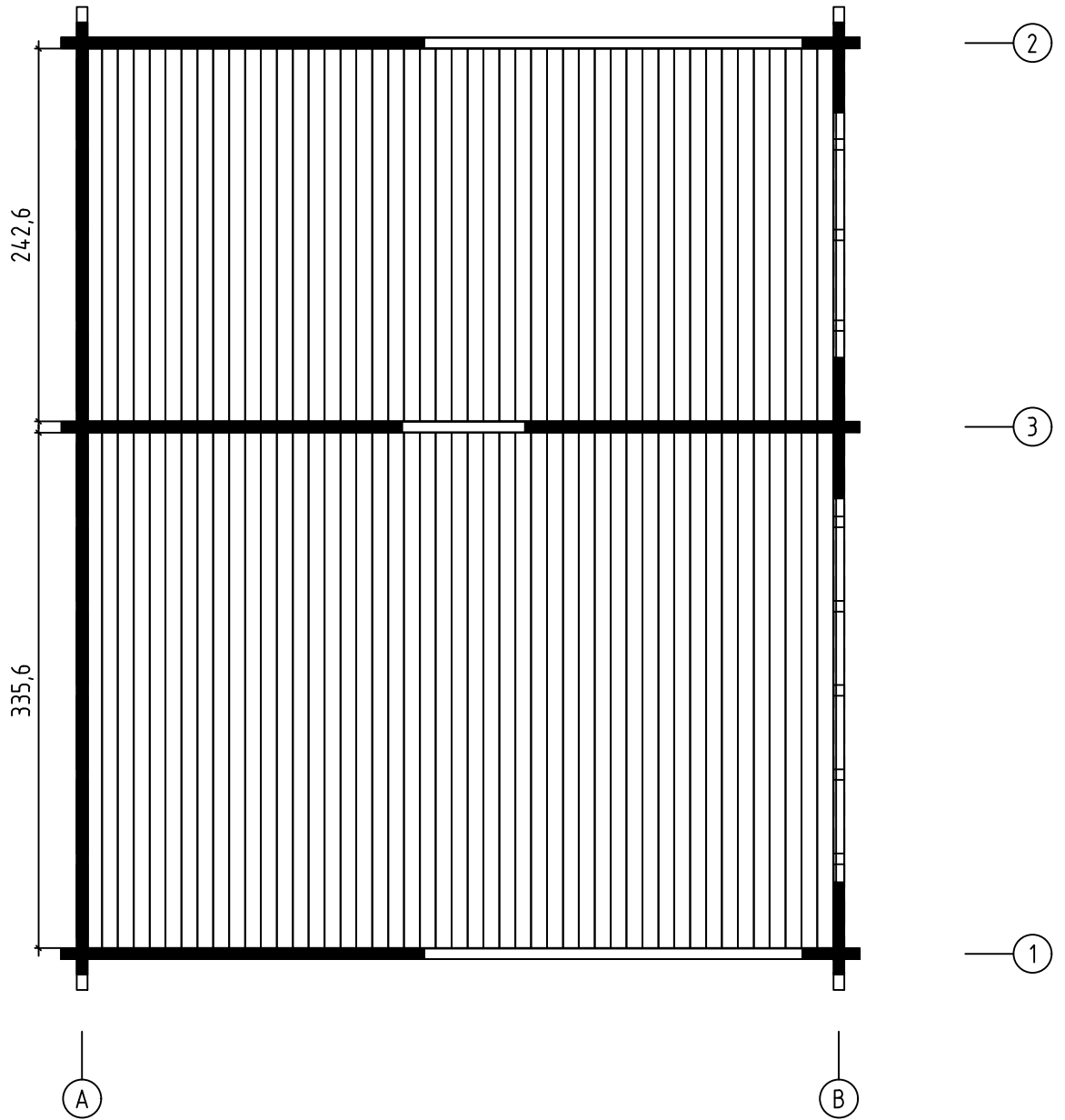

Malmö, Art.No.7015041

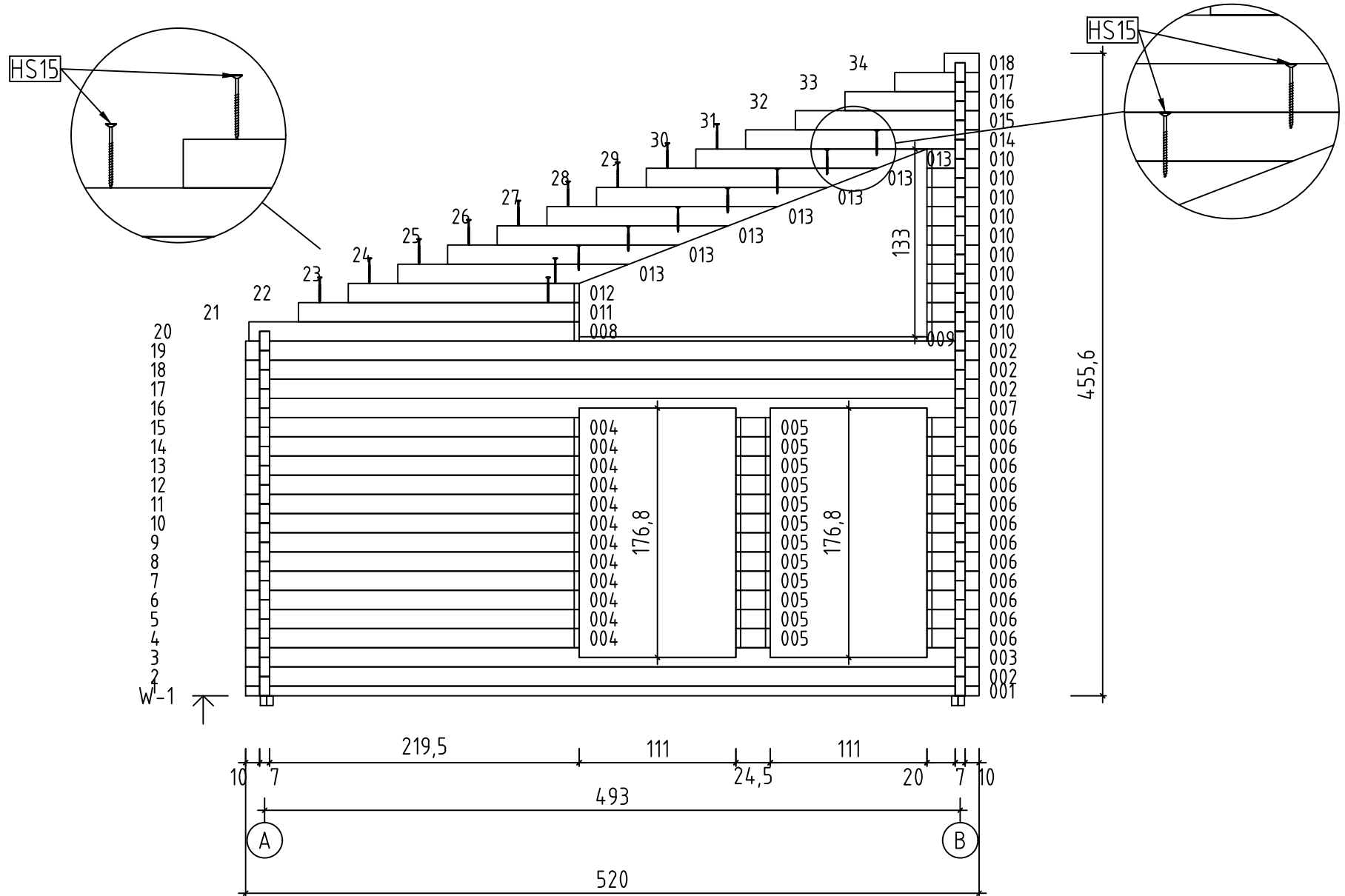

Malmö, Art.No.7015041

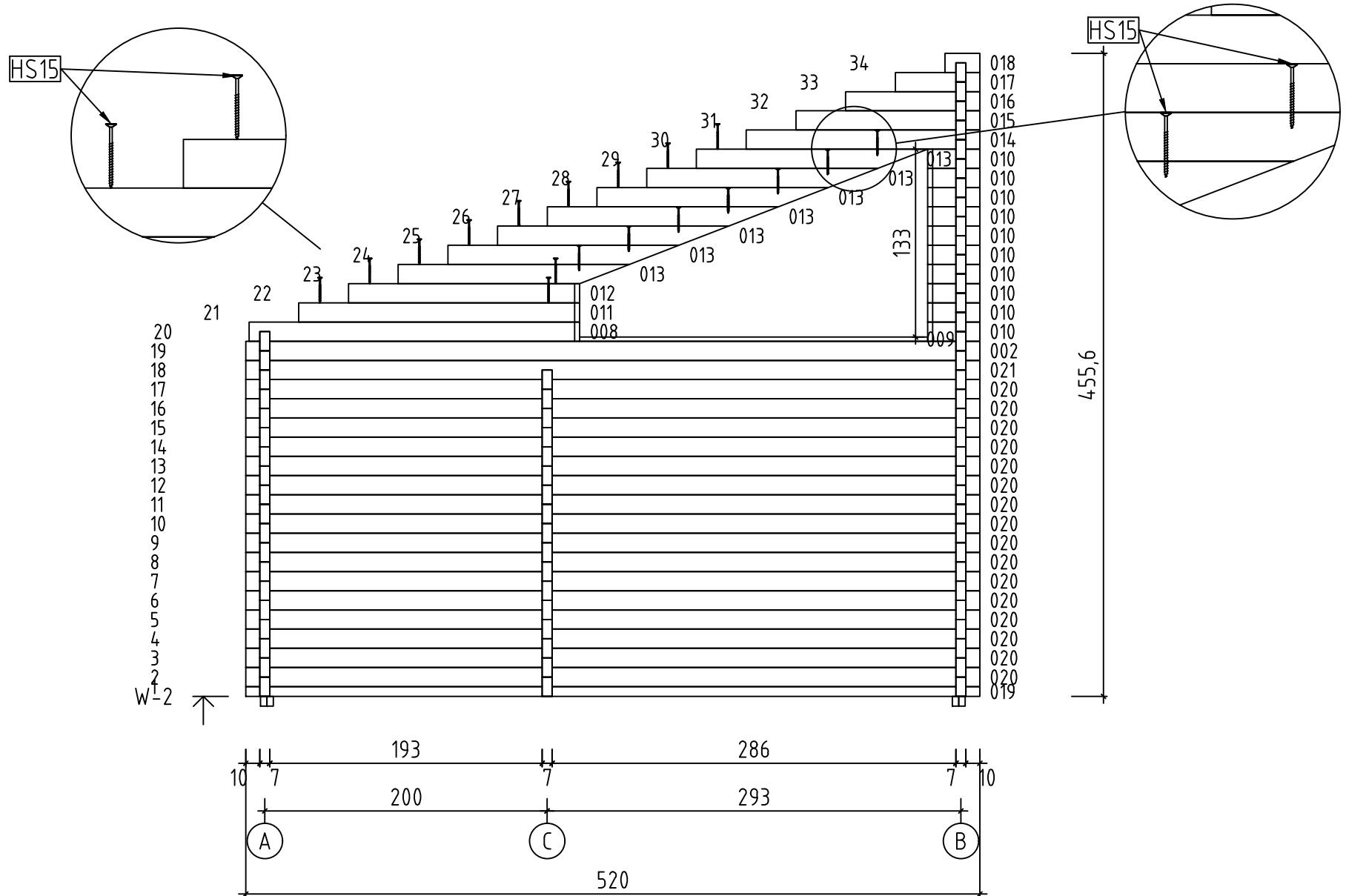

Malmö, Art.No.7015041

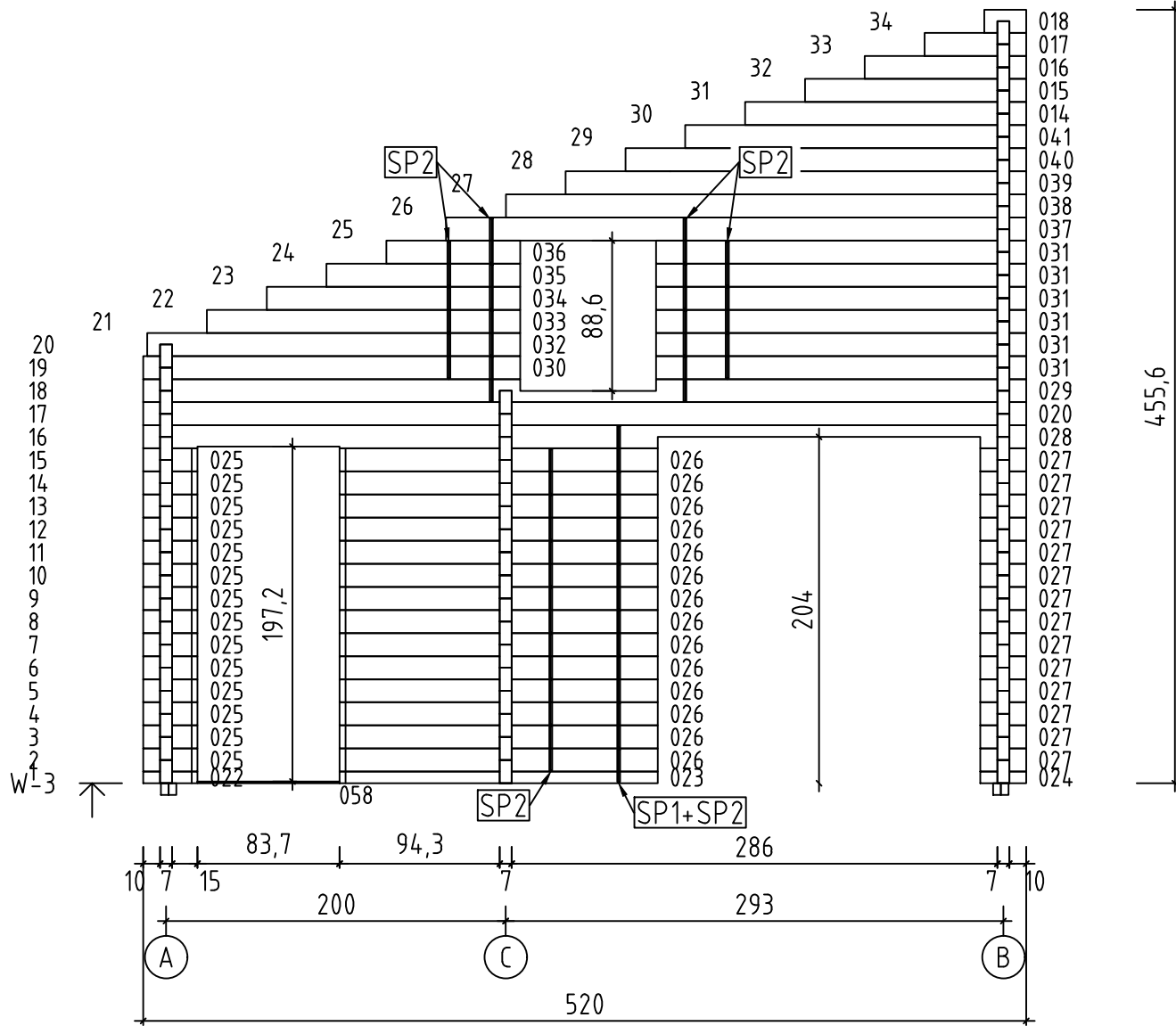

Malmö, Art.No.7015041

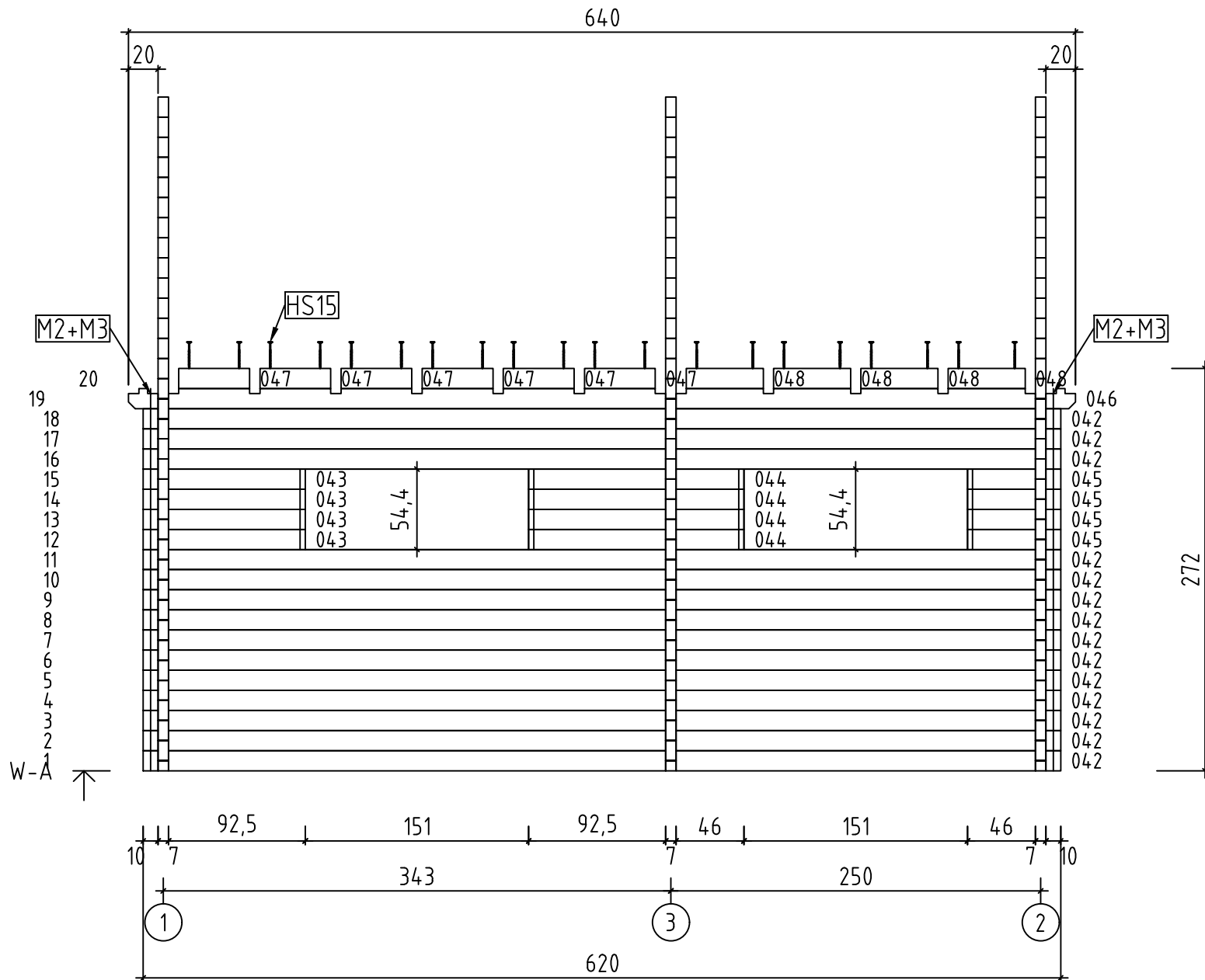

Malmö, Art.No.7015041

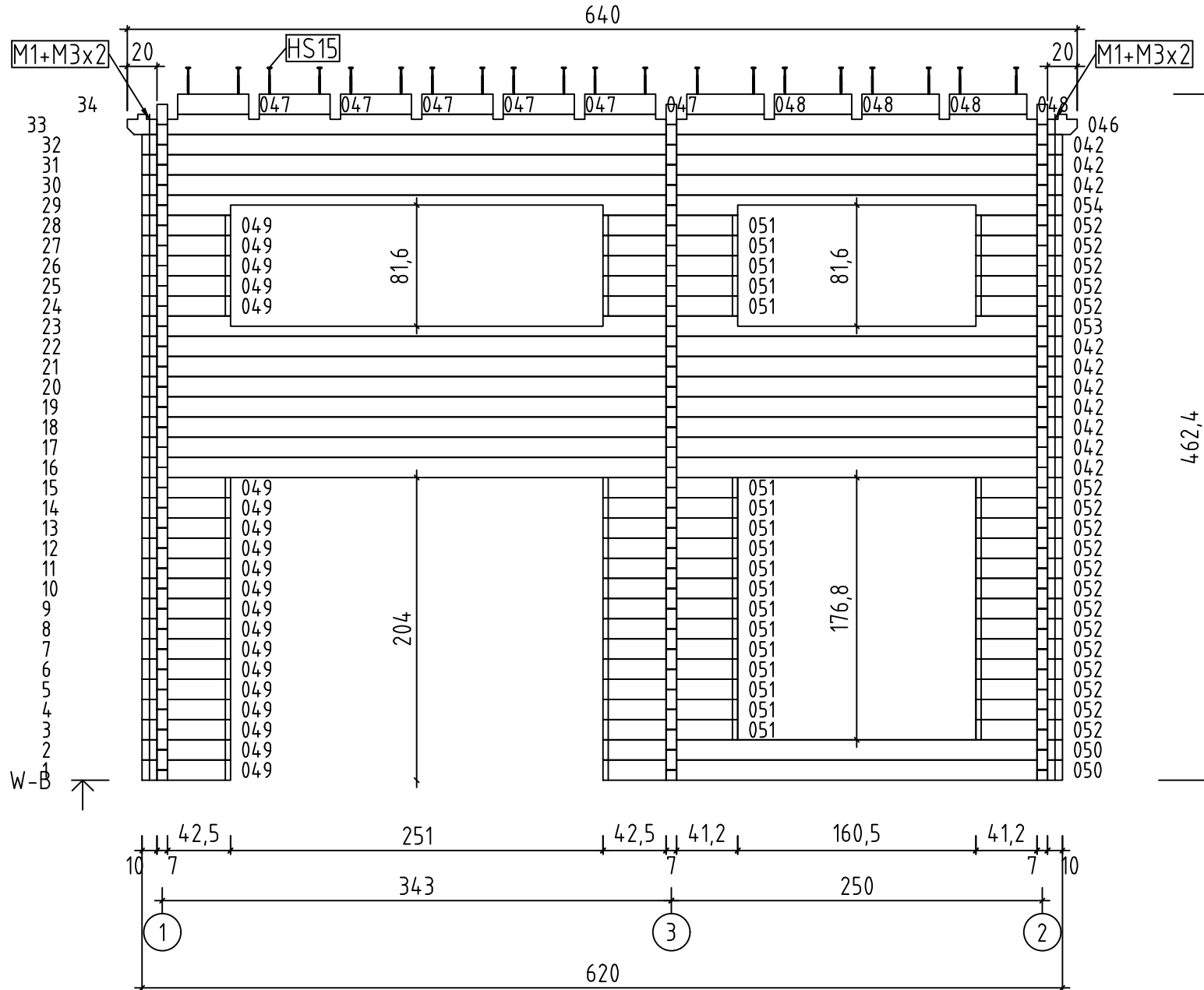



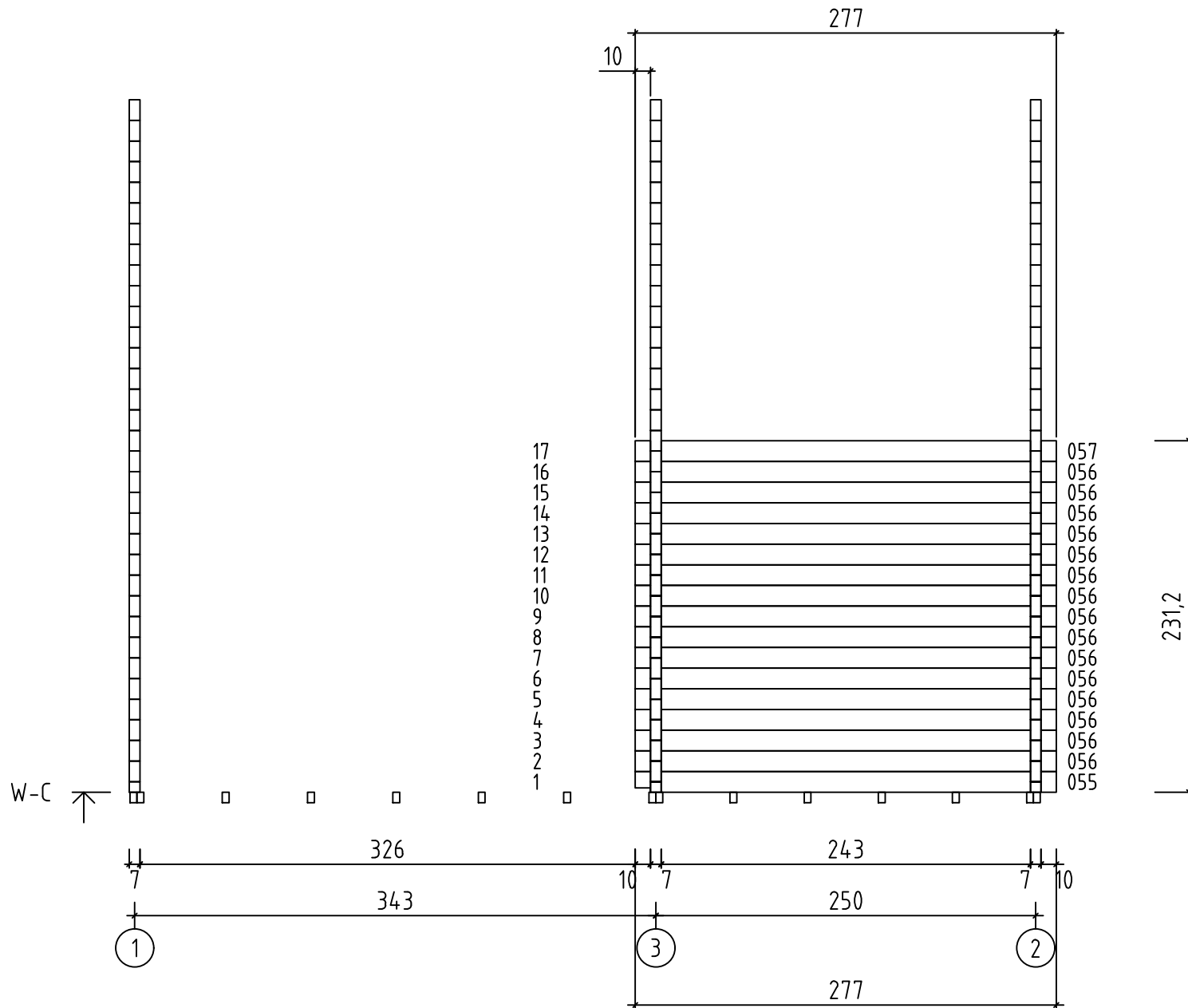



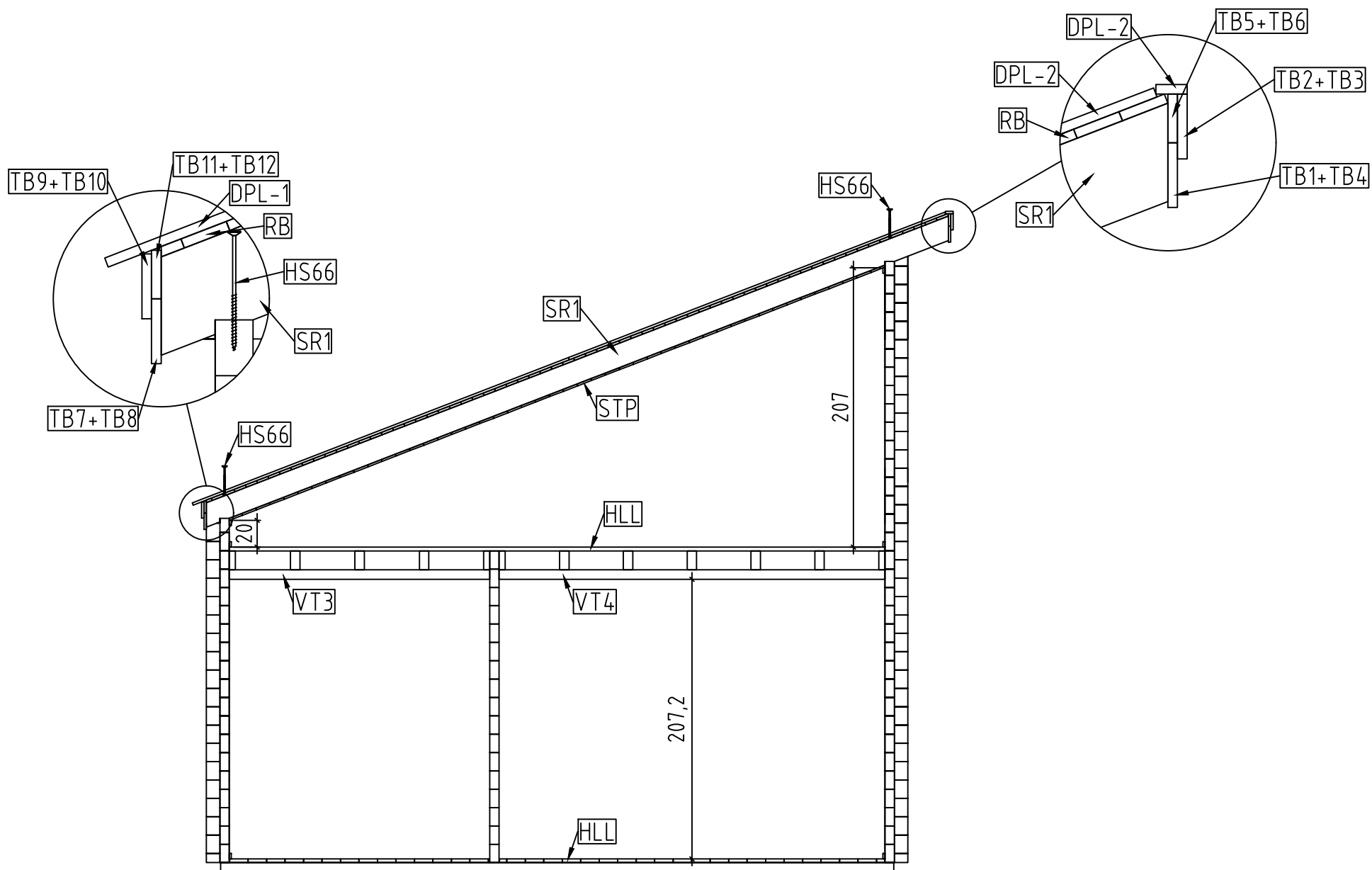

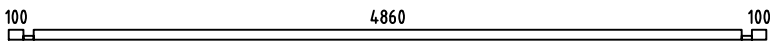
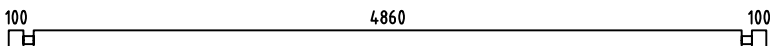
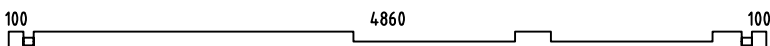
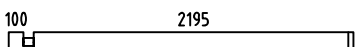

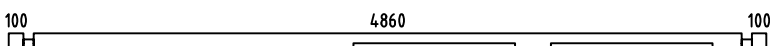
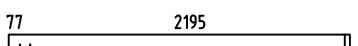
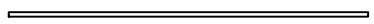

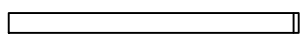

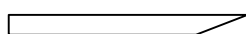
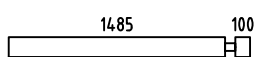
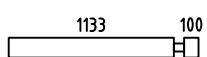
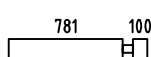
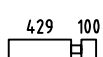

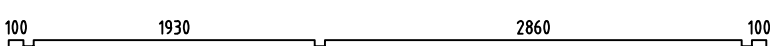
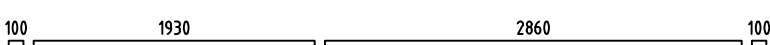
Malmö, Art.No.7015041

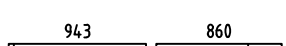



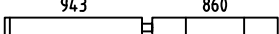

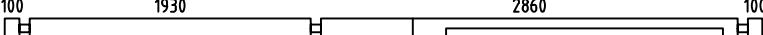
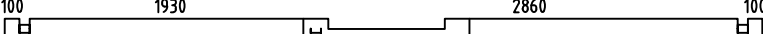
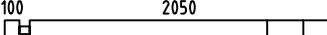
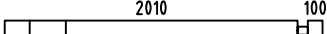
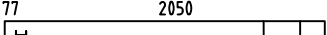
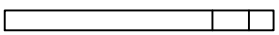
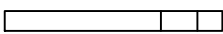
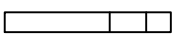
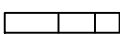
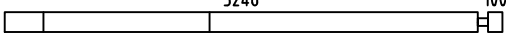
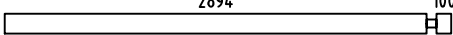
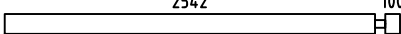
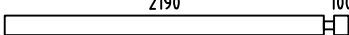
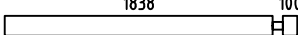
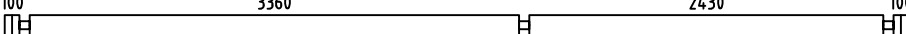
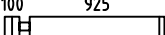
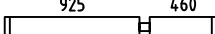

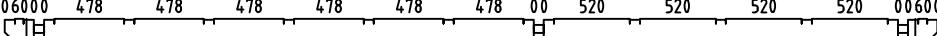

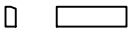
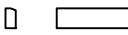

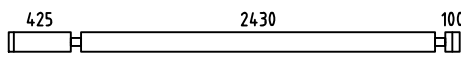
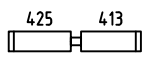

Malmö, Art.No.7015041

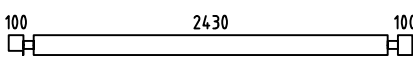
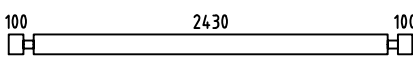
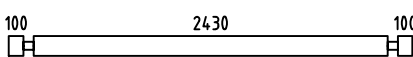

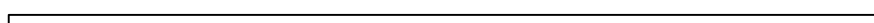

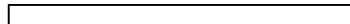
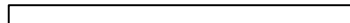
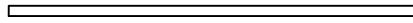
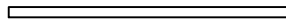
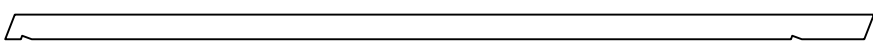
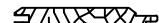

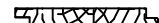

Pos	Malmö, Art.No.7015041 Piece list - Stückliste - Liste des pièces - Elementi - Stuklijst - Tükítabel	Q	P (mm)	L (mm)
001		1	70x68	5200
002		5	70x136	5200
003		1	70x136	5200
004		12	70x136	2365
005		12	70x136	245
006		12	70x136	370
007		1	70x136	5200
008		2	70x136	2342
009		2	70x30	2466
010		20	70x136	369
011		2	70x136	1990
012		2	70x136	1638
013		14	70x136	1638
014		3	70x136	1655
015		3	70x136	1303
016		3	70x136	951
017		3	70x136	599
018		3	70x136	247
019		1	70x68	5200
020		17	70x136	5200
021		1	70x136	5200
022		1	70x68	320
023		1	70x68	1873

Pos	Malmö, Art.No.7015041 Piece list - Stückliste - Liste des pièces - Elementi - Stuklijst - Tükitabel	Q	P (mm)	L (mm)
024	100 100 	1	70x68	270
025	100 150 	14	70x136	320
026	943 860 	14	70x136	1873
027	100 100 	14	70x136	270
028	100 1930 2860 100 	1	70x136	5200
029	100 1930 2860 100 	1	70x136	5200
030	100 2050 	1	70x136	2220
031	2010 100 	6	70x136	2180
032	77 2050 	1	70x136	2197
033		1	70x136	1845
034		1	70x136	1493
035		1	70x136	1140
036		1	70x136	788
037	3246 100 	1	70x136	3416
038	2894 100 	1	70x136	3064
039	2542 100 	1	70x136	2712
040	2190 100 	1	70x136	2360
041	1838 100 	1	70x136	2008
042	100 3360 2430 100 	24	70x136	6200
043	100 925 	4	70x136	1095
044	925 460 	4	70x136	1455
045	460 100 	4	70x136	630
046	06000 478 478 478 478 478 478 00 520 520 520 520 00600 	2	70x136	6400

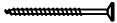
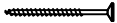
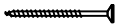
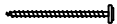
Pos	Malmö, Art.No.7015041 Piece list - Stückliste - Liste des pièces - Elementi - Stuklijst - Tükitabel	Q	P (mm)	L (mm)
047		12	70x136	478
048		8	70x136	520
049		20	70x136	595
050		2	70x136	3095
051		18	70x136	908
052		18	70x136	583
053		1	70x136	6200
054		1	70x136	6200
055		1	70x136	2770
056		15	70x136	2770
057		1	70x136	2770
058		1	70x10	837
IAR1	Foundation - Fundament - Fondation - Fondamenta - Fundering - Immutatud alusraam 	4	45x70	5990
IAR2	Foundation - Fundament - Fondation - Fondamenta - Fundering - Immutatud alusraam 	15	45x70	4810
VT2	Mezzanine floor joists - Halbgeschoss balken - Solives de plancher mezzanine - Travi del pavimento mezzanino - Plaatduim scharnier - Vahelaetalad 	8	70x140	2430
VT1	Mezzanine floor joists - Halbgeschoss balken - Solives de plancher mezzanine - Travi del pavimento mezzanino - Plaatduim scharnier - Vahelaetalad 	4	45x140	2430
VT4	Mezzanine floor joists - Halbgeschoss balken - Solives de plancher mezzanine - Travi del pavimento mezzanino - Plaatduim scharnier - Vahelaetalad 	2	45x70	2860
VT3	Mezzanine floor joists - Halbgeschoss balken - Solives de plancher mezzanine - Travi del pavimento mezzanino - Plaatduim scharnier - Vahelaetalad 	2	45x70	1930
SR1	Rafter - Dachsparren - Chevron - Trave - Dak spar - Sarikas 	16	70x170	5962
STP	Ceiling boards - Deckenbrett - Voliges sous plafond - Tavole per piano soffitto - Dakhout - Laelaud 	47	111x14	3356
STP	Ceiling boards - Deckenbrett - Voliges sous plafond - Tavole per piano soffitto - Dakhout - Laelaud 	47	111x14	2426
HLL	Floor boards - Fussbodenbretter - Lame de plancher - Pavimento - Vloerhout - Põrandalaud 		137x28	322 m.
RB	Roof boards - Dachbretter - Voliges - Perlina per tetto - Dakhout - Katuselaud 	66	90x18	3353

Pos	Malmö, Art.No.7015041 Piece list - Stückliste - Liste des pièces - Elementi - Stuklijst - Tükítabel	Q	P (mm)	L (mm)
RB	Roof boards - Dachbretter - Voliges - Perlina per tetto - Dakhout - Katuselaud 	66	90x18	3047
LL	Ceiling fillet - Deckeleiste - Profil de finition sous plafond - Massello per soffitto - Dakafdekljst - Laeliist 		15x40	33 m.
FL	Floor fillet - Fussbodenleiste - Corniere de finition du plancher - Finitura per pavimento (battisco pa) - Vloerafwerkljst - Põrandaliist 		15x40	45 m.
DPL-1	Roofing felt fillet - Dachpappenleiste - Baguette de fixation du feutre bitumeux - Asse per fissaggio guaina bituminosa - Afdekljst asfaltpapier - Katusepapiliist 	4	18x58	2990
DPL-2	Roofing felt fillet - Dachpappenleiste - Baguette de fixation du feutre bitumeux - Asse per fissaggio guaina bituminosa - Afdekljst asfaltpapier - Katusepapiliist 	2	18x58	3236
M1	Treaded rod m12 - Gewindestange m12 - Tige filetée m12 - Barra filettata passo m12 - Draadstang 12m - Keermelatt 	2		500
M2	Treaded rod m12 - Gewindestange m12 - Tige filetée m12 - Barra filettata passo m12 - Draadstang 12m - Keermelatt 	2		600
M3	Treaded rod m12 - Gewindestange m12 - Tige filetée m12 - Barra filettata passo m12 - Draadstang 12m - Keermelatt 	6		2000
TB1	Fascia board - Traufbrett - Bandeau de toit - Finitura lati tetto - Gevelljst - Räästalaud 	1	18x120	2841
TB2	Fascia board - Traufbrett - Bandeau de toit - Finitura lati tetto - Gevelljst - Räästalaud 	1	18x120	3083
TB3	Fascia board - Traufbrett - Bandeau de toit - Finitura lati tetto - Gevelljst - Räästalaud 	1	18x120	3389
TB4	Fascia board - Traufbrett - Bandeau de toit - Finitura lati tetto - Gevelljst - Räästalaud 	1	18x120	3631
TB7	Fascia board - Traufbrett - Bandeau de toit - Finitura lati tetto - Gevelljst - Räästalaud 	1	18x120	2085
TB8	Fascia board - Traufbrett - Bandeau de toit - Finitura lati tetto - Gevelljst - Räästalaud 	1	18x120	3595
TB9	Fascia board - Traufbrett - Bandeau de toit - Finitura lati tetto - Gevelljst - Räästalaud 	1	18x120	3047
TB10	Fascia board - Traufbrett - Bandeau de toit - Finitura lati tetto - Gevelljst - Räästalaud 	1	18x120	3353
TB5	Fascia board - Traufbrett - Bandeau de toit - Finitura lati tetto - Gevelljst - Räästalaud 	1	18x90	3083
TB6	Fascia board - Traufbrett - Bandeau de toit - Finitura lati tetto - Gevelljst - Räästalaud 	1	18x90	3389
TB11	Fascia board - Traufbrett - Bandeau de toit - Finitura lati tetto - Gevelljst - Räästalaud 	1	18x90	2085
TB12	Fascia board - Traufbrett - Bandeau de toit - Finitura lati tetto - Gevelljst - Räästalaud 	1	18x90	3595
TBE6	Fixing fillet - Fixierungsleiste - Profil de fixation - Massello di fissaggio - Bevestiging lijstwerk - Tenderliist 	2	28x34	340
TBE6	Fixing fillet - Fixierungsleiste - Profil de fixation - Massello di fissaggio - Bevestiging lijstwerk - Tenderliist 	4	28x34	510
TBE6	Fixing fillet - Fixierungsleiste - Profil de fixation - Massello di fissaggio - Bevestiging lijstwerk - Tenderliist 	4	28x34	645

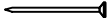
Pos	Malmö, Art.No.7015041 Piece list - Stückliste - Liste des pièces - Elementi - Stuklijst - Tükítabel	Q	P (mm)	L (mm)
TBE6	Fixing fillet - Fixierungsleiste - Profil de fixation - Massello di fissaggio - Bevestiging lijstwerk - Tenderliist 	2	28x34	1290
TBE6	Fixing fillet - Fixierungsleiste - Profil de fixation - Massello di fissaggio - Bevestiging lijstwerk - Tenderliist 	4	28x34	1592
TBE6	Fixing fillet - Fixierungsleiste - Profil de fixation - Massello di fissaggio - Bevestiging lijstwerk - Tenderliist 	2	28x34	1729
TBE6	Fixing fillet - Fixierungsleiste - Profil de fixation - Massello di fissaggio - Bevestiging lijstwerk - Tenderliist 	2	28x34	1922
TBE6	Fixing fillet - Fixierungsleiste - Profil de fixation - Massello di fissaggio - Bevestiging lijstwerk - Tenderliist 	2	28x34	2000
GL3	Gable moulding - Giebelleiste - Planche de rive - Finitura per frontale e retro del tetto - Gevellijst - Viilulaud 	2	18x90	3000
GL3	Gable moulding - Giebelleiste - Planche de rive - Finitura per frontale e retro del tetto - Gevellijst - Viilulaud 	2	18x90	3000
GL-1	Gable moulding - Giebelleiste - Planche de rive - Finitura per frontale e retro del tetto - Gevellijst - Viilulaud 	2	18x120	2983
GL-1	Gable moulding - Giebelleiste - Planche de rive - Finitura per frontale e retro del tetto - Gevellijst - Viilulaud 	2	18x120	2983
GL-2	Gable moulding - Giebelleiste - Planche de rive - Finitura per frontale e retro del tetto - Gevellijst - Viilulaud 	2	18x120	3000
GL-2	Gable moulding - Giebelleiste - Planche de rive - Finitura per frontale e retro del tetto - Gevellijst - Viilulaud 	2	18x120	3000
KL4	Lengthening bolt for threaded rod - Verlängerungsmutter für gewindestange - Manchon de raccordement de tige filetée - Bullone per barra filettata passo - Extensie moer voor draadstang - Jätikumutter keermelatfile 	6		
KL1	Drive nut threaded rod - Einschlagmutter für gewindestange - Écrou a frapper pour tige filitée - Dado guida per barra filettata - Aandrijfmoer / aanslagmoer voor draadstang - Löökmutter keermelatfile 	4		
KL2	Nut for threaded rod - Mutter für gewindestange - Écrou pour tige filetée - Dado per barra filettata - Moer voor draadstang - Mutter keermelatfile 	4		
KL3	Plain washer threaded rod - Unterlegscheibe für gewindestange - Rondelle plate pour tige filitée - Rondella per barra filettata - Sluitring voor draadeind - Seib keermelatfile 	4		
HS25	Screw for floor - Schrauben für fussbodenbretter - Vis pour plancher - Viti per le perline del pavimento - Schroef voor vloerhout - Kruvi põrandale 	726	3.5x50	
HS32	Screw for fascia boards - Schrauben für traufbretter - Vis pour fixation bandeau de toit - Viti x striscia del tetto - Schroef voor gevellijst - Kruvi räästalauale 	140	3.5x50	
HS84	Screw for fixing fillet of door and window - Schrauben für fixierungsleiste - Vis pour profil vertical de fixation pour ouvertures des fenetres et portes - Viti per massello di fissaggio - Schroeven voor bevestiging van deur en raam lijsten - Kruvi tenderliistudele 	94	3.5x50	
HS16	Screw for gable moulding - Schrauben für giebelleiste - Vis pour fixation planche de rive - Vite per fissare finiture davanti e dietro del tetto - Schroef voor gevellijst - Kruvi viilulauale 	120	3.5x50	
NFD	Screw for roofing felt fillet - Schrauben für dachpappeneiste - Vis pour fixation baguette de fixation feutre bitumeux - Vite per massellino del feltro del tetto - Schroef voor asfaltpaier afdekljst - Kruvi katusepapiliistule 	44	4x40	
HS36	Screw for stepladder - Schraube für leiter - Vis d'assemblage des marches de l'échelle - Vite per scaletta - Schroef voor trapladder - Kruvi redeli montaažiks 	36	4x60	
HS89	Screw for loft support - Schraube für dachbefestigung - Vis pour cornière de renfort de fixation - Viti per supporto del soppalco - Schroef voor dakbevestiging - Kruvi vahelae kandurliistule 	96	5x100	
HS40	Screw for 1. wall beam - Schraube für 1. bohnenreihe - Vis de fixations 1ere rangée de madriers avec poutrelles de fondations - Vite fissaggio alle fondamenta - Schroef voor 1 wandbalk - Kruvi poollauale 	15	5x120	

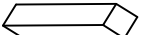
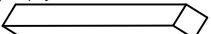
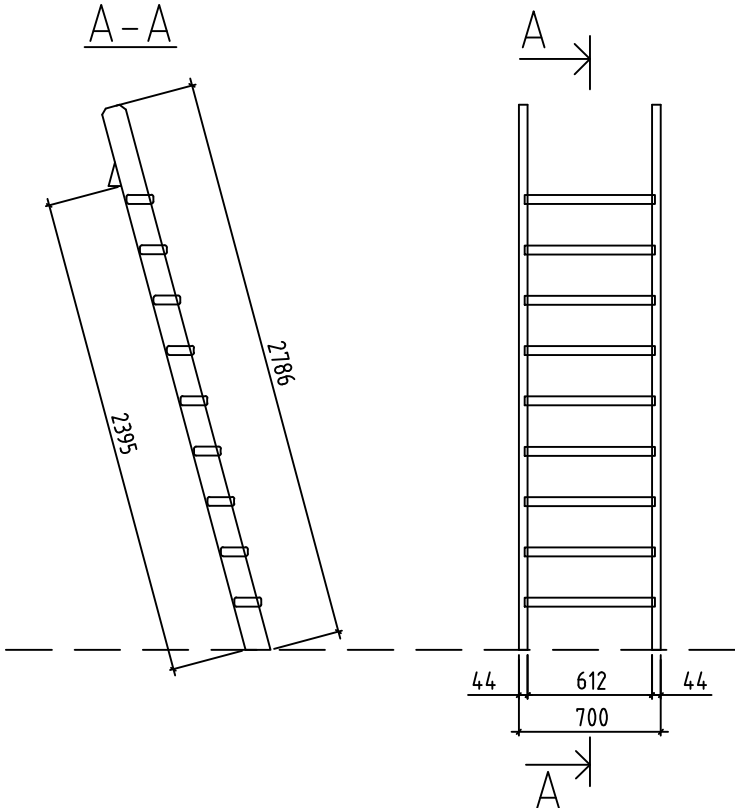
Pos	Malmö, Art.No.7015041 Piece list - Stückliste - Liste des pièces - Elementi - Stuklijst - Tükítabel	Q	P (mm)	L (mm)
HS39	Screw for foundation - Schrauben zur befestigung fundament - Vis de fixations des poutrelles de fondations - Viti x fundamenta - Schroef voor fundering - Krugi alusraamile 	46	5x90	
HS15	Screw for wall details - Schraube für wand details - Vis pour mur details - Viti per elementi della porta - Schroef voor wand details - Krugi seinadetailidele 	78	6x180	
HS66	Screw for rafter - Schrauben für dachsparren - Vis pour chevron - Vite per trave - Schroef voor dakspar - Krugi sarikatele 	32	8x220	
MS	Screw for doorstep - Schrauben für swelle - Vis pour fixation barre de seuil - Vite per soglia della porta - Schroef voor deurdorpel - Krugi lävepakule 	7	4.5x65	
SH70	Hammer block - Schlagholz - Calle de frappe - Blocco di legno da usare come cuscinetto quando si usa il martello - Stagklos - Löögiklots 	2		
NFC	Zn nail for ceiling fillet - Zn nägel deckeleiste - Pointe pour profil de finition sous plafond - Chiodi zincati per massellini del soffitto - Spijker(nagel) voor plafond afdekljst - Nael laeliistule 	66	1.4x40	
NFF	Zn nail for floor fillet - Zn nägel für fussbodenleiste - Pointe pour corniere de finition du plancher - Chiodi x fissaggio pavimento - Spijker(nagel) voor vloer afdekljst - Nael põrandaliistule 	90	1.4x40	
NF2	Zn nail for roof - Zn nägel für dachbretter - Pointe pour fixation voliges de toit - Chiodi x perline tetto - Spijker(nagel) voor dakhout - Nael katuselauale 	1122	2.1x50	
NF2	Zn nail for ceiling boards - Zn nägel für deckenbretter - Clous pour voliges sous plafonds - Chiodo per il tavolo del soffitto - Spijkers voor plafondplaat - Nael laelauale 	658	2.1x50	
ORZ	Montage set for doors and windows - Montage set für türen und fenster - Jeu de montage portes et fenetres - Set di assemblaggio per porte e finestre - Montage set voor deur en raam - Orthez akna ja ukse montaaživahendid	1		
SP1	Hidden fixing - Holzdübel - Tourillon bois - Fissaggio a scomparsa - Verloren kop spijker - Salapulk 	1		
SP2	Hidden fixing - Holzdübel - Tourillon bois - Fissaggio a scomparsa - Verloren kop spijker - Salapulk 	28		
LR	Ladder - Leiter - Echelle - Scala a pioli - Ladder - Redel 	1		

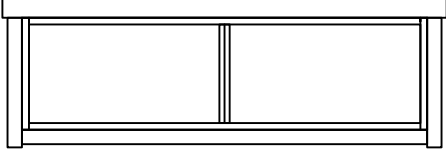
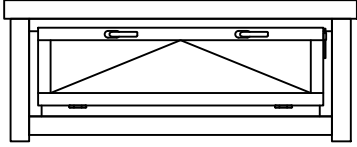
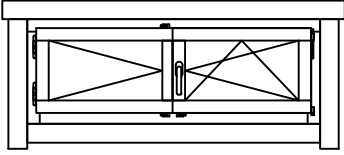
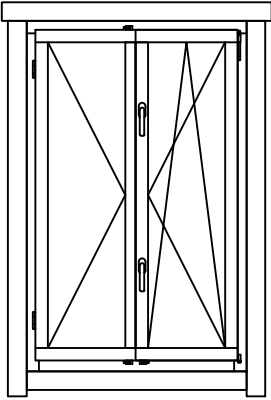
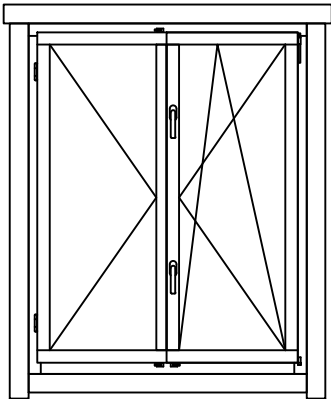
Pos	Malmö, Art.No.7015041 Piece list - Stückliste - Liste des pièces - Elementi - Stuklijst - Tükitabel	Q	P (mm)	L (mm)
	Window - Fenster - Fenetre - Finestra - Raam - Aken 2500x780 2+ A.0M.K 	1		
	Window - Fenster - Fenetre - Finestra - Raam - Aken 1500x510 2+ A.0Ü.K 	2		
	Window - Fenster - Fenetre - Finestra - Raam - Aken 1595x780 2+ TA.0P.bK 	1		
	Window - Fenster - Fenetre - Finestra - Raam - Aken 1100x1729 2+ TA.0P.bK 	2		
	Window - Fenster - Fenetre - Finestra - Raam - Aken 1595x1729 2+ TA.0P.bK 	1		

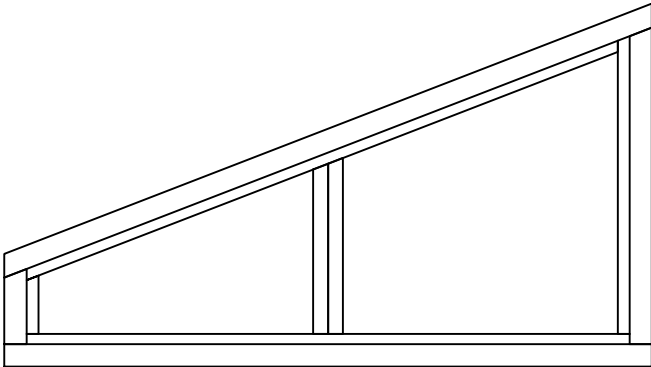
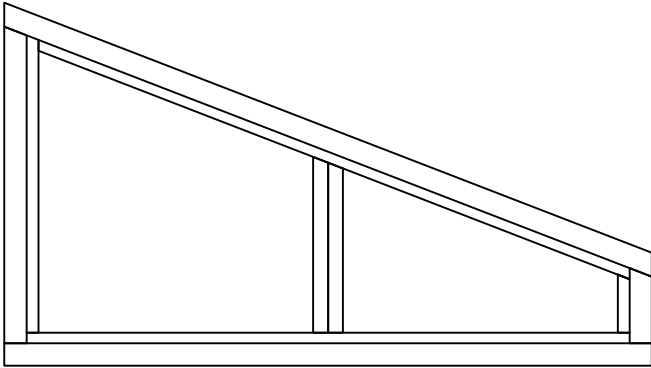
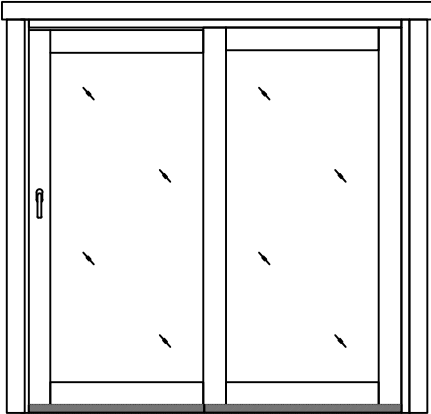
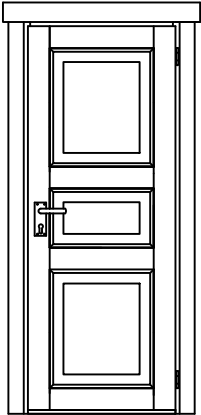
Pos	<p>Malmö, Art.No.7015041</p> <p>Piece list - Stückliste - Liste des pièces - Elementi - Stuklijst - Tükítabel</p>	Q	P (mm)	L (mm)
	<p>Window - Fenster - Fenetre - Finestra - Raam - Aken 2455x1284 2+ KA.0P.K</p> 	1		
	<p>Window - Fenster - Fenetre - Finestra - Raam - Aken 2455x1284 2+ KA.0V.K</p> 	1		
	<p>Door - Tür - Porte - Porte - Deur - Uks 2500x2000 3+ TU2L.10P.K</p> 	1		
	<p>Door - Tür - Porte - Porte - Deur - Uks 827x1933 U.3TP</p> 	1		

