

Exeter 1
Art.No. 7012202

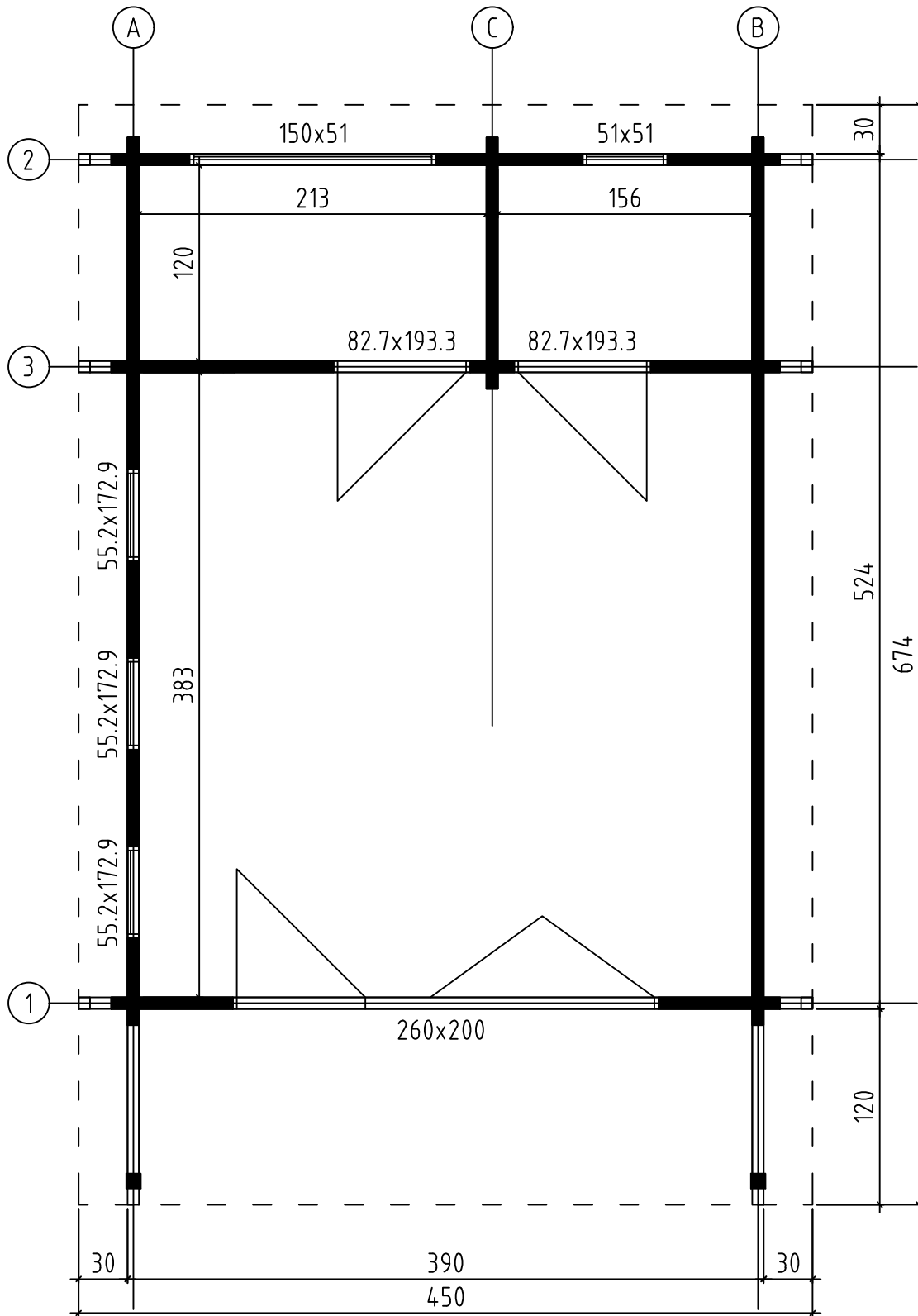

Exeter 1 - Art.No.7012202
GROUNDPLAN - GRUNDPLAN - PLAN DE MASSE



Exeter 1 - Art.No.7012202
 FOUNDATION - FUNDAMENT - FONDATION

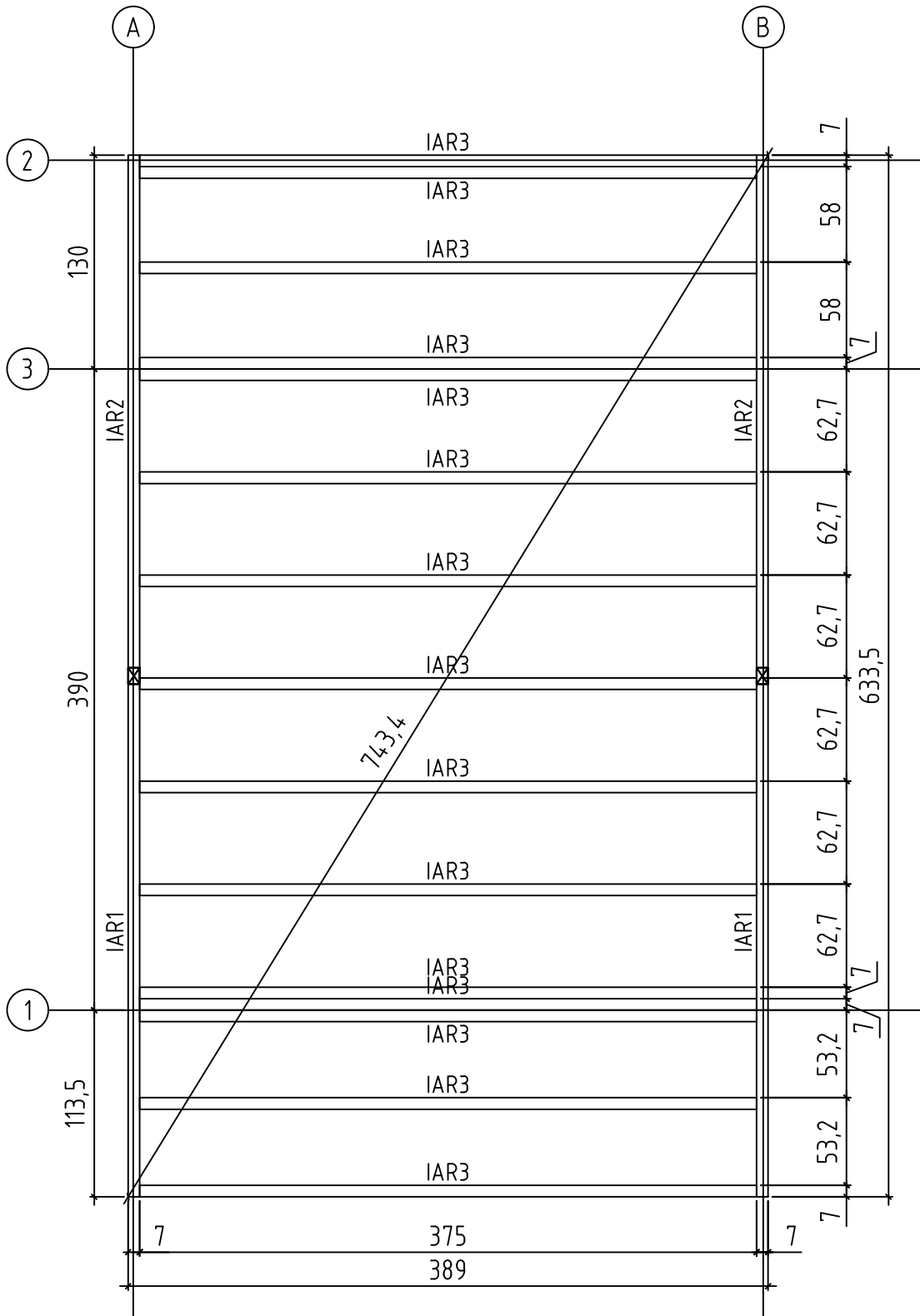

Exeter 1 - Art.No.7012202
RAFTERS PLAN - DACHSPARREN - PLAN DE CHEVRON

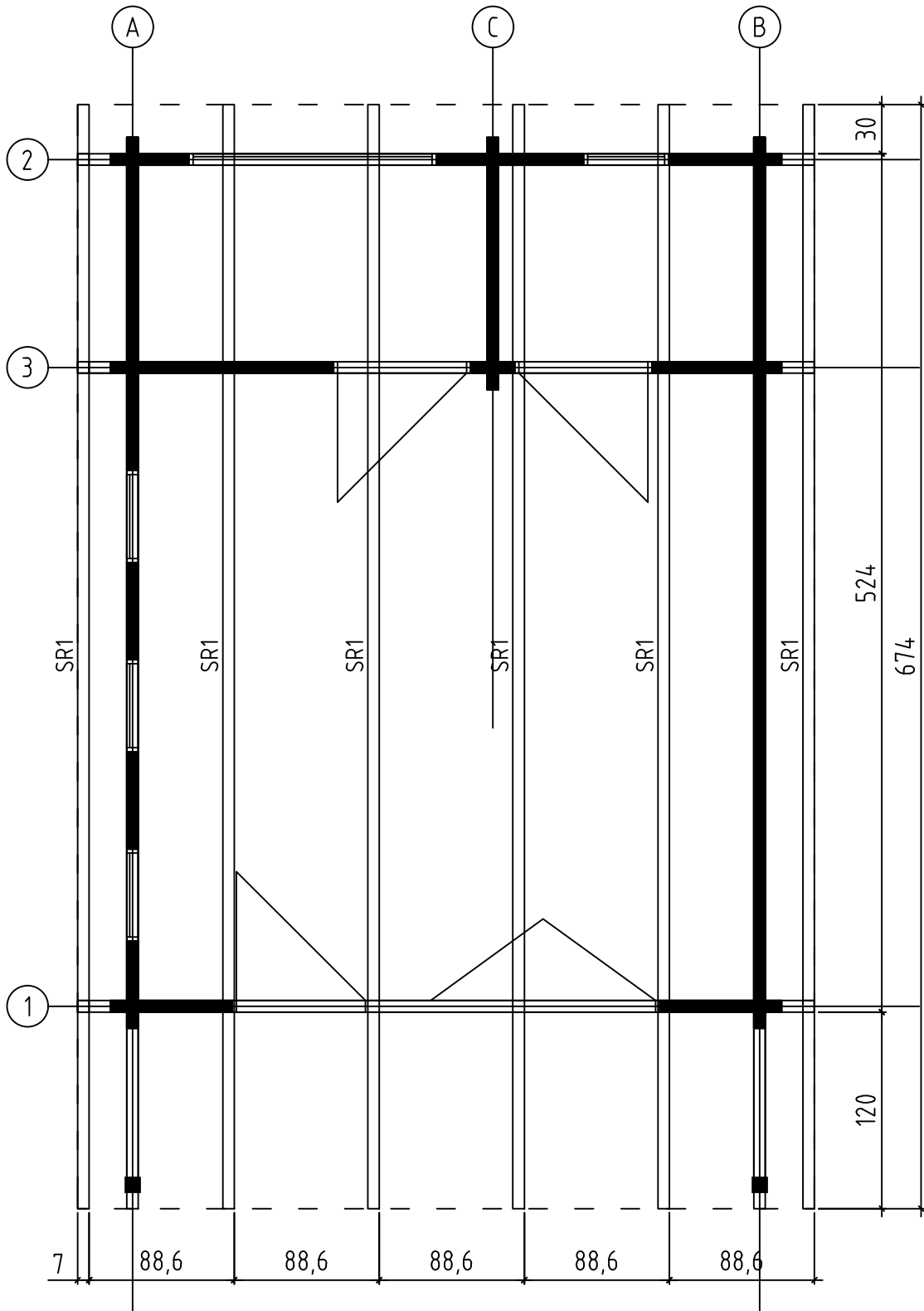

Exeter 1 - Art.No.7012202
FLOOR BOARDS - FUSSBODENBRETTER - PLAN POSE PLANCHER

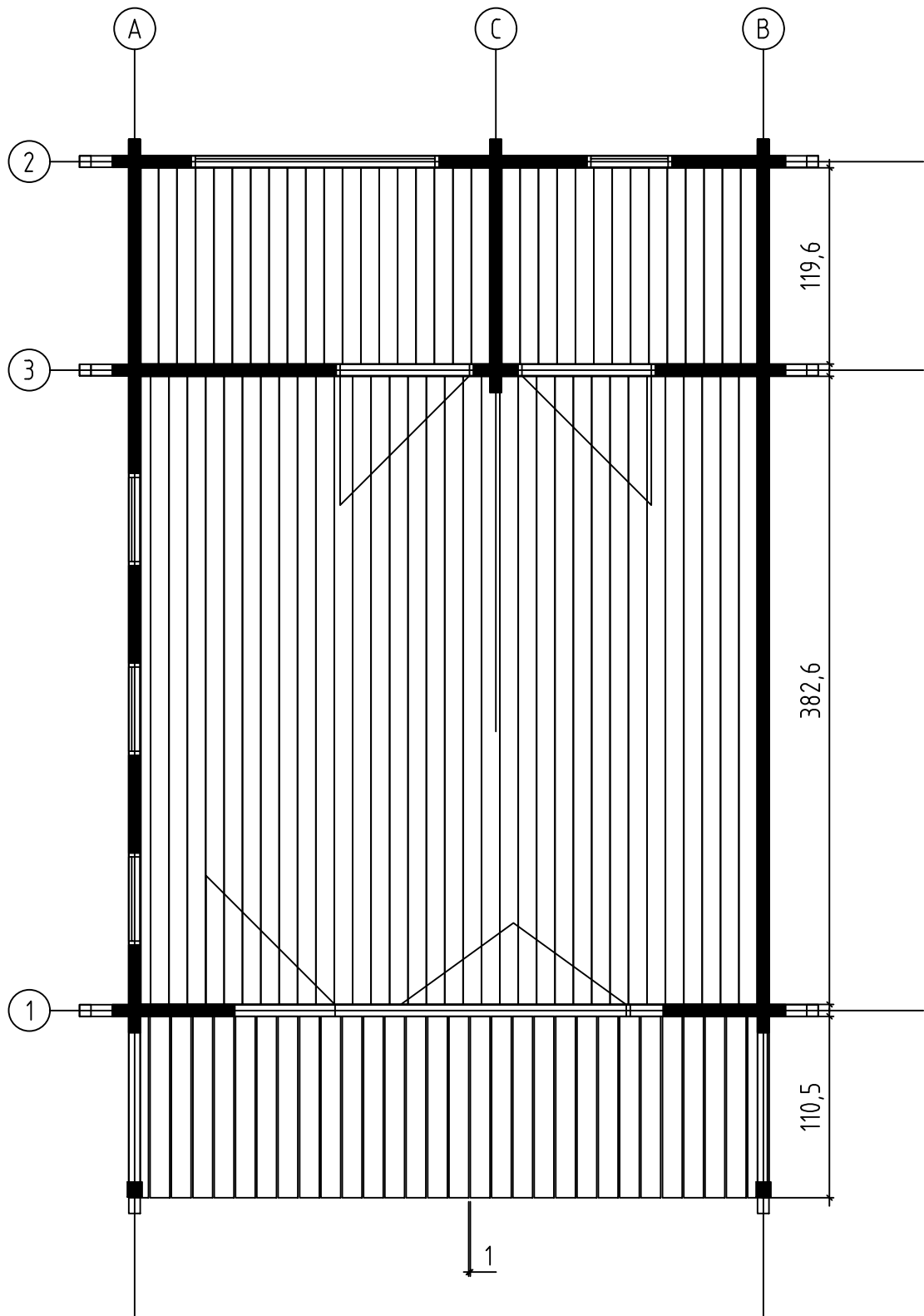

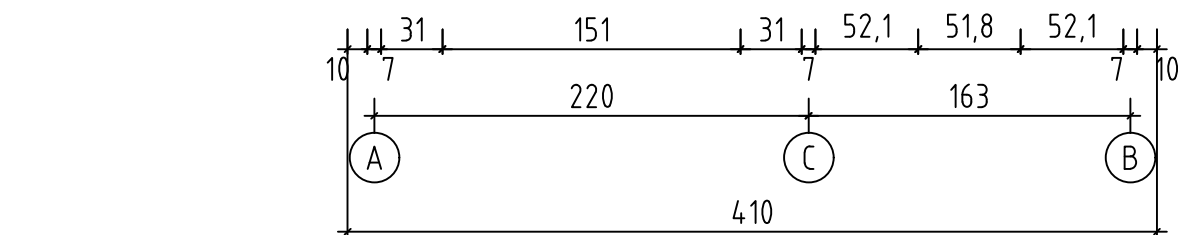
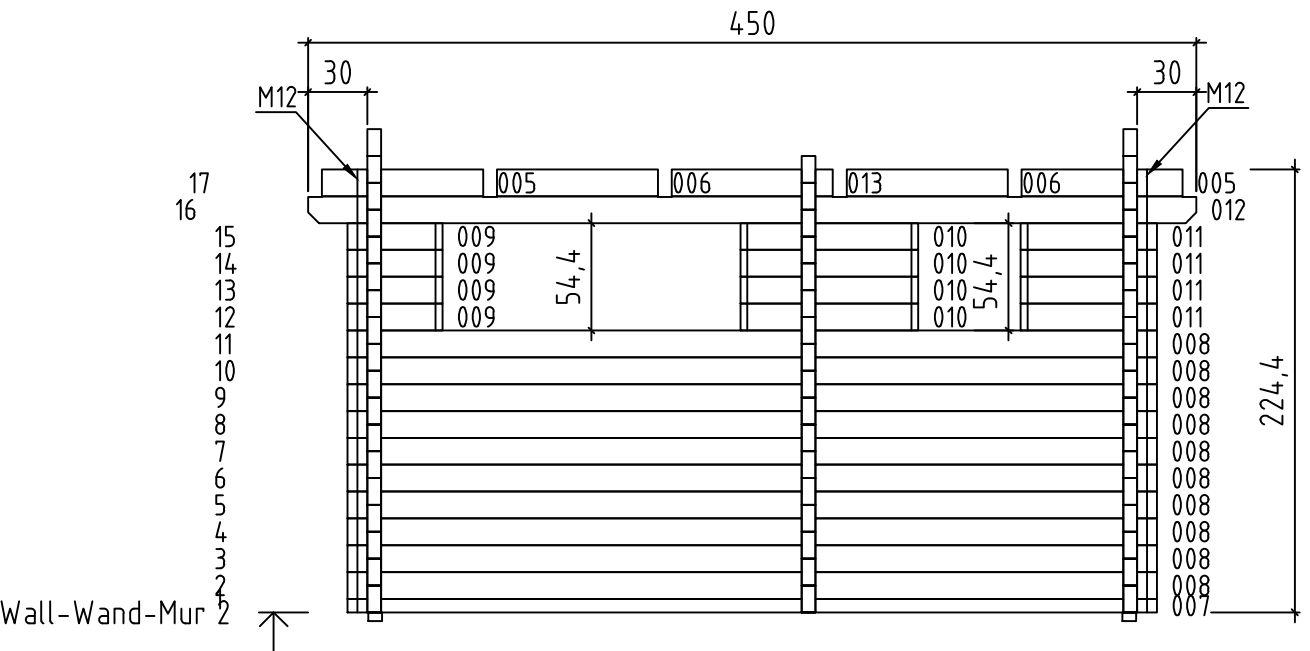
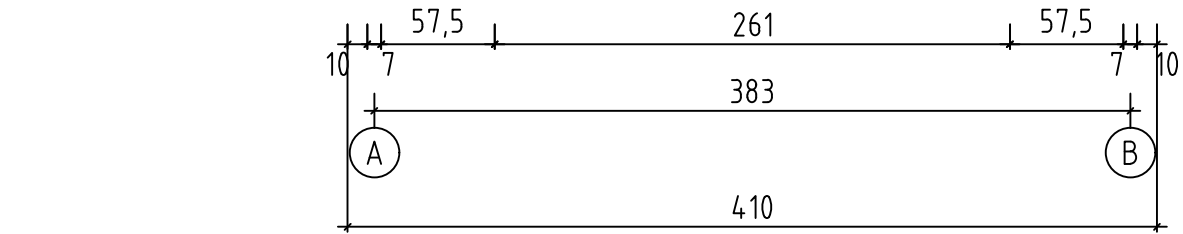
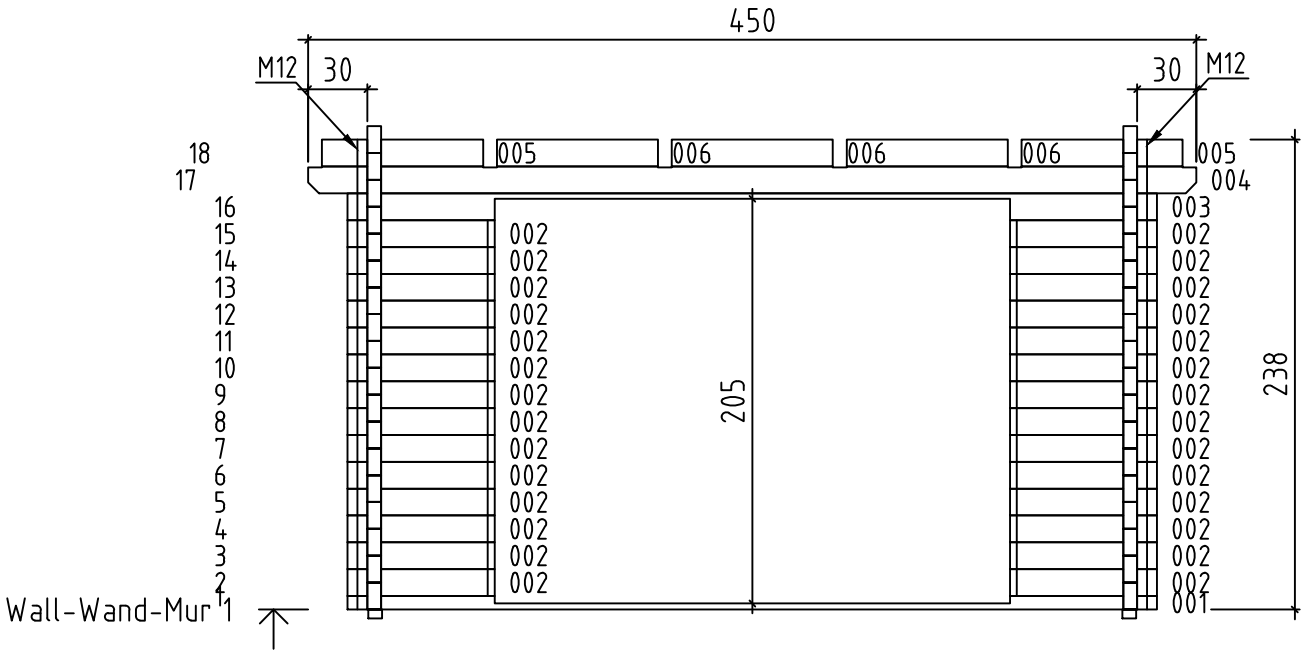

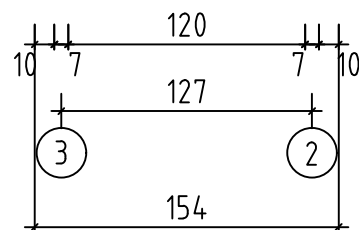
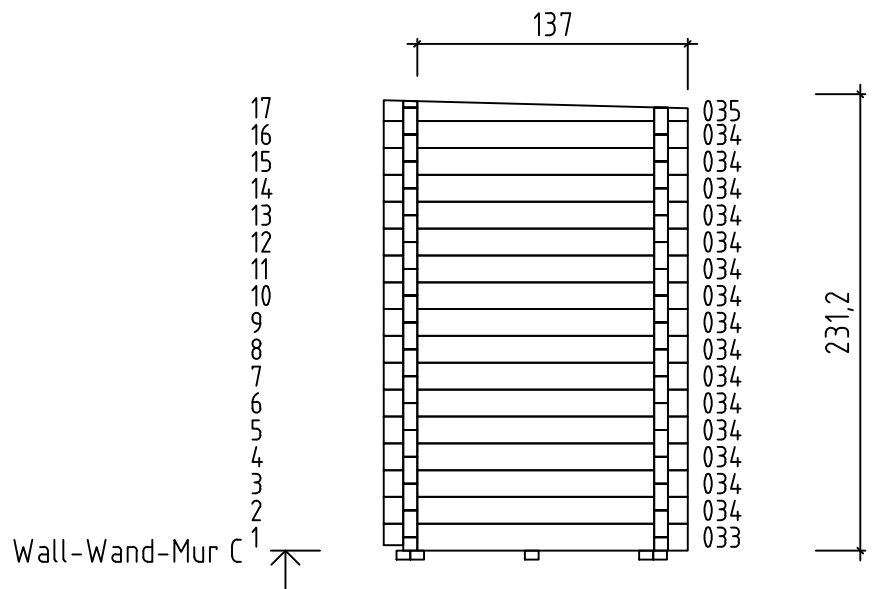
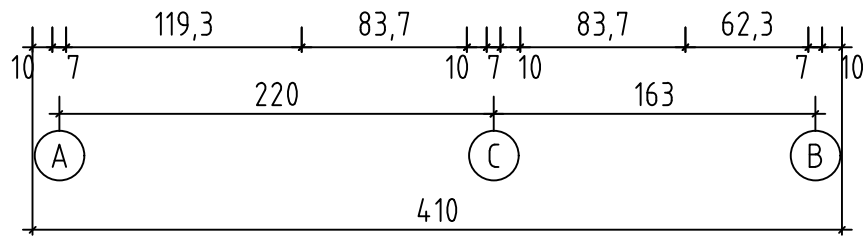
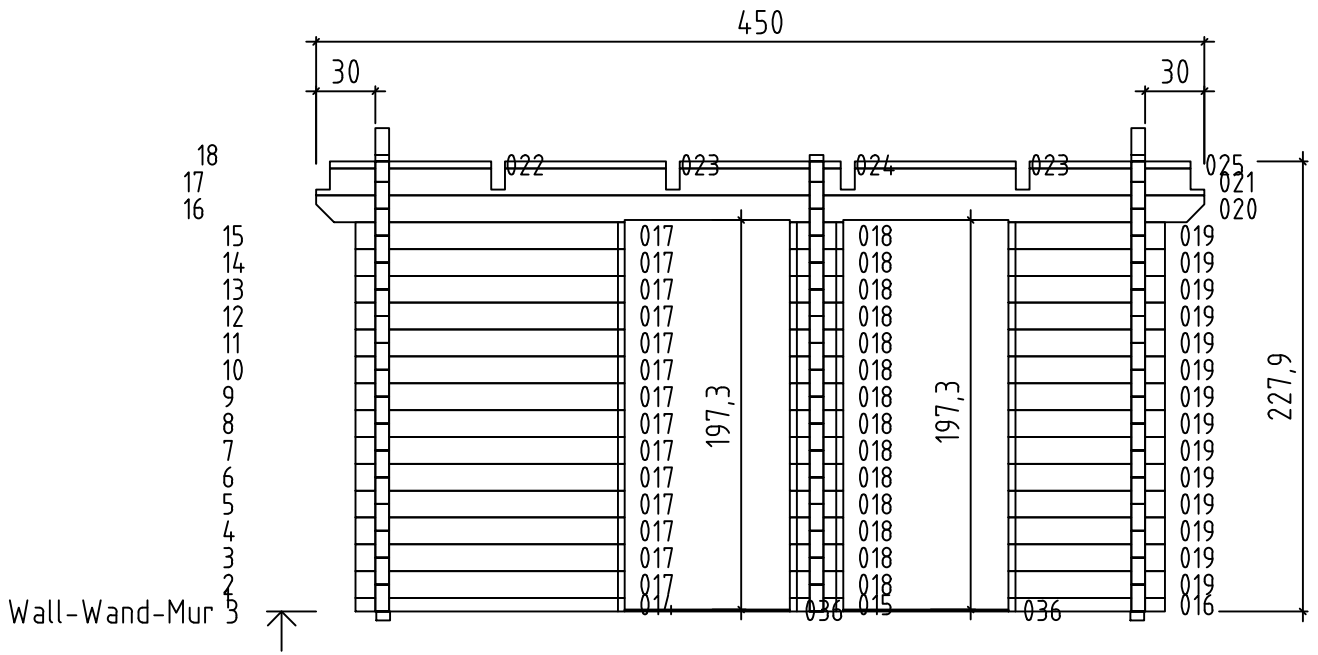



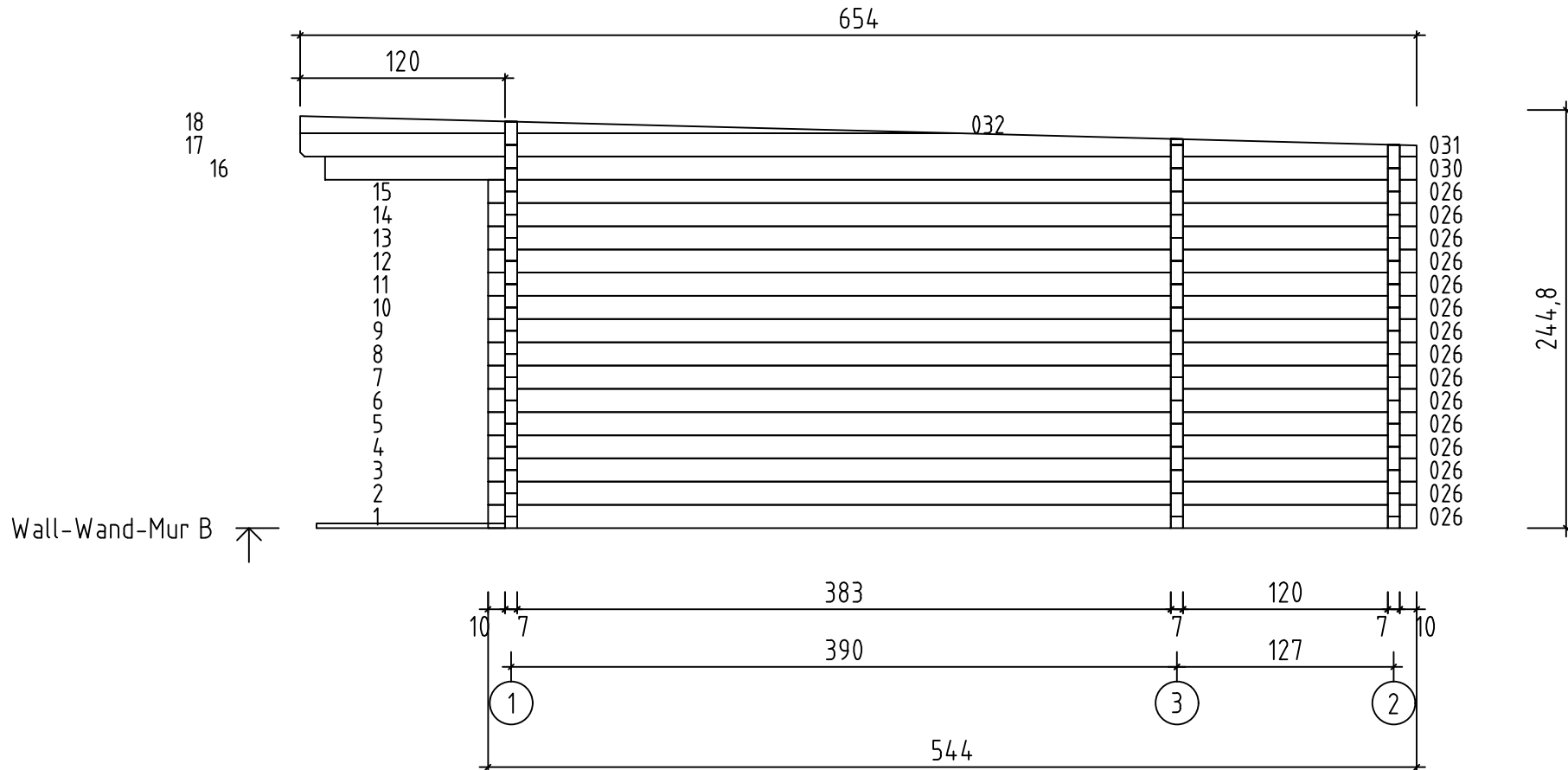

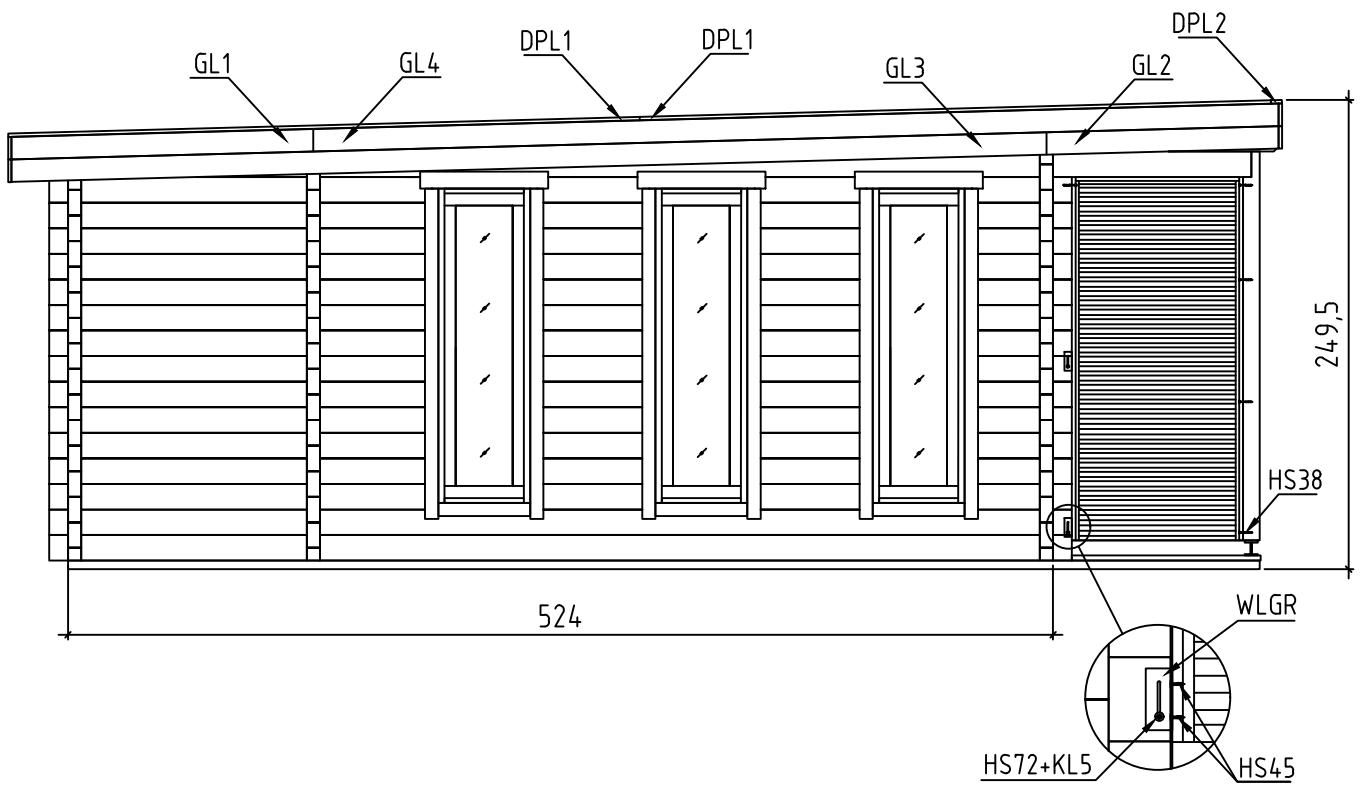
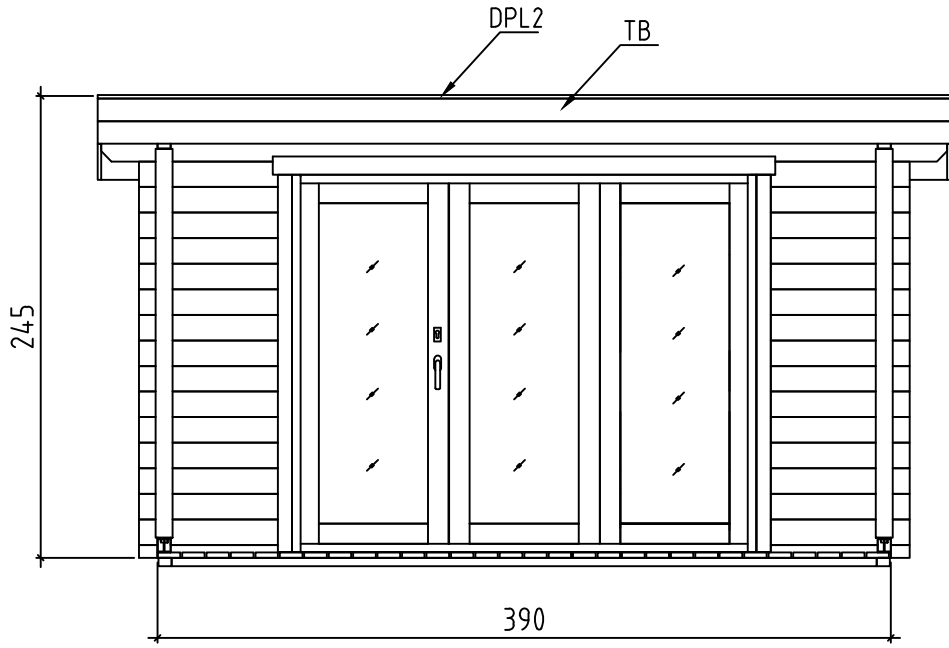



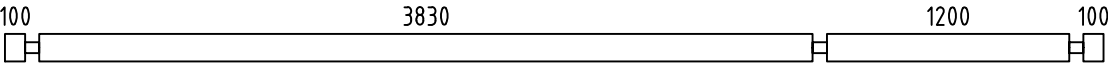
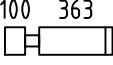
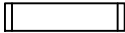
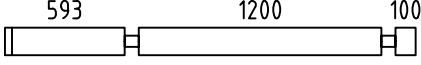
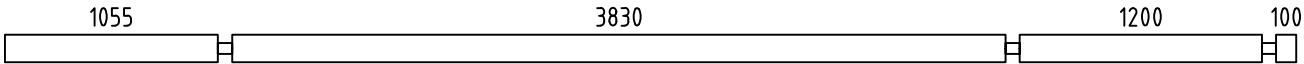
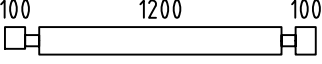
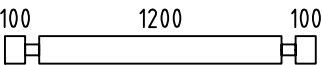
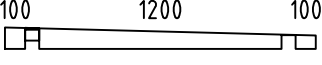

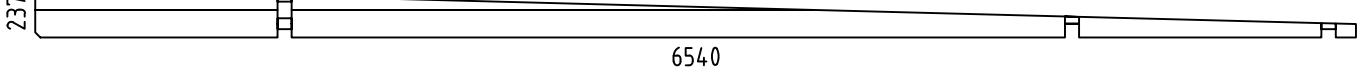
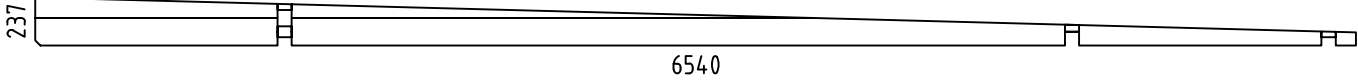
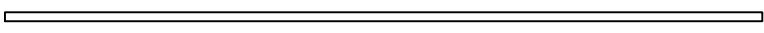
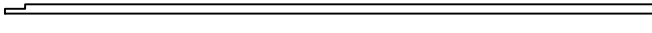
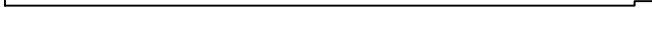
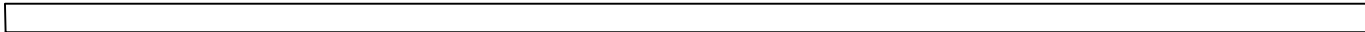
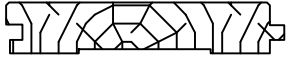



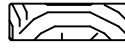

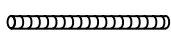
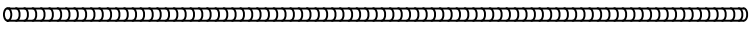





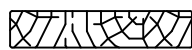



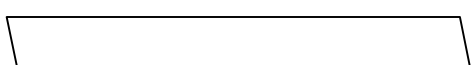
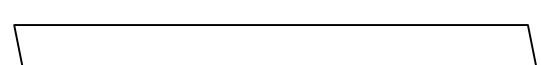

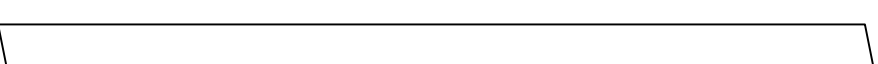
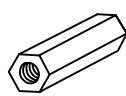

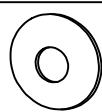
Exeter 1 - Art.No.7012202



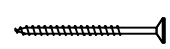

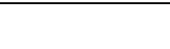

Pos	Exeter 1 - Art.No.7012202 Piece list - Stückliste - Liste des pieces	Q.	P (mm)	L (mm)
001		1	70x68	4100
002		28	70x136	745
003		1	70x136	4100
004		1	70x136	4500
005		4	70x136	816
006		5	70x136	816
007		1	70x68	4100
008		10	70x136	4100
009		4	70x136	480
010		4	70x136	901
011		4	70x136	691
012		1	70x136	4500
013		1	70x136	816
014		1	70x68	1363
015		1	70x68	270
016		1	70x68	793
017		14	70x136	1363
018		14	70x136	270
019		14	70x136	793
020		1	70x136	4500
021		1	70x136	4500
022		1	70x35	816
023		2	70x35	816
024		1	70x35	816
025		1	70x35	816

Pos	Exeter 1 - Art.No.7012202 Piece list - Stückliste - Liste des pieces	Q.	P (mm)	L (mm)
026		17	70x136	5440
027		13	70x136	533
028		26	70x136	593
029		13	70x136	2034
030		2	70x136	6395
033		1	70x136	1540
034		15	70x136	1540
035		1	70x106	1540
036		2	70x10	837
WA-1		1		
WB-1		1		
IAR3	FOUNDATION - FUNDAMENT - FONDATION 	15	70x45	3750
IAR2	FOUNDATION - FUNDAMENT - FONDATION 	2	70x45	3218
IAR1	FOUNDATION - FUNDAMENT - FONDATION 	2	70x45	3218
SR1	RAFTER - DACHSPARREN - CHEVRON 	6	70x140	6746
PTL	FLOOR BOARDS - FUSSBODENBRETTER - LAME DE PLANCHER 		137x28	r.m. 154.92
	ROOF BOARDS - DACHBRETTER - VOLIGES 	75	90x18	4500
SV2	TERRACE BOARDS - TERRASSENBRETTER - PLANCHER DE TERRASSE 	30	120x28	1105
	FLOOR FILLET-FUSSBODENLEISTE - CORNIERE DE FINITION DU PLANCHER 		15x40	27.3 m.
DPL1	ROOFING FELT FILLET - DACHPAPPENLEISTE - BAGUETTE DE FIXATION DU FEUTRE BITUMEUX 	4	18x58	3360
DPL2	ROOFING FELT FILLET - DACHPAPPENLEISTE - BAGUETTE DE FIXATION DU FEUTRE BITUMEUX 	1	18x58	4538
M12	TREADED ROD M12 - GEWINDESTANGE M12 - TIGE FILETÉE M12 	2		270
M12	TREADED ROD M12 - GEWINDESTANGE M12 - TIGE FILETÉE M12 	2		410
M12	TREADED ROD M12 - GEWINDESTANGE M12 TIGE FILETÉE M12 	4		2000
LPL	FIXING FILLET - FIXIRUNGSLEISTE - PROFIL DE FIXATION 	1	18x70	791

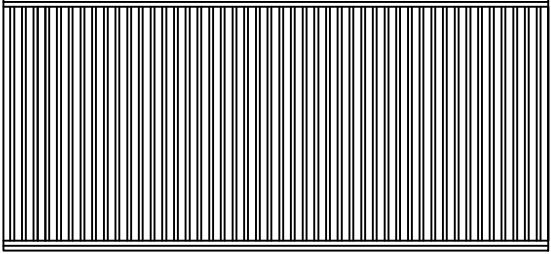
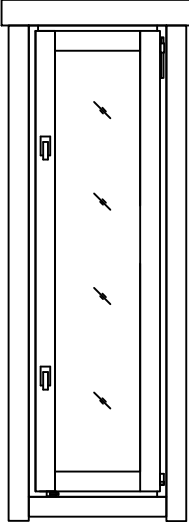
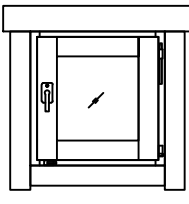
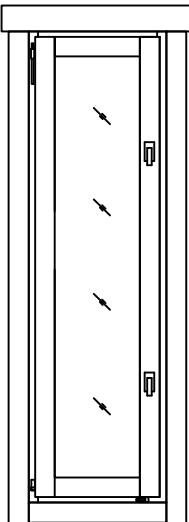
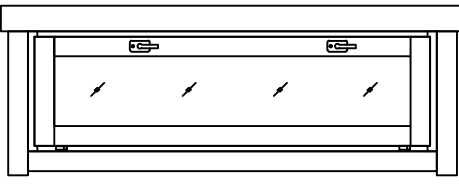
Pos	Exeter 1 - Art.No.7012202 Piece list - Stückliste - Liste des pieces	Q.	P (mm)	L (mm)
LPL	FIXING FILLET - FIXIRUNGSLEISTE - PROFIL DE FIXATION 	2	18x70	1933
P	POST - PFOSTEN - POTEAU 	2	90x90	2070
TB	EAVES BOARD - TRAUFBRETT - BANDEAU DE TOIT 	4	18x120	4538
TBE6	FIXING FILLET FOR WINDOW - FIXIRUNGSLEISTE FÜR FENSTER - PROFIL DE FIXATION DES FENETRES 	4	28x34	510
TBE6	FIXING FILLET FOR WINDOW - FIXIRUNGSLEISTE FÜR FENSTER - PROFIL DE FIXATION DES FENETRES 	6	28x34	1729
TBE6	FIXING FILLET FOR DOOR - FIXIRUNGSLEISTE FÜR TÜR - PROFIL DE FIXATION DES PORTES 	2	28x34	1836
TBE6	FIXING FILLET FOR DOOR - FIXIRUNGSLEISTE FÜR TÜR - PROFIL DE FIXATION DES PORTES 	4	28x34	1933
GL1	GABLE MOULDING - GIEBELLEISTE PLANCHE DE RIVE 	2	18x120	1237
GL2	GABLE MOULDING - GIEBELLEISTE PLANCHE DE RIVE 	2	18x120	1609
GL3	GABLE MOULDING - GIEBELLEISTE PLANCHE DE RIVE 	2	18x120	5140
GL4	GABLE MOULDING - GIEBELLEISTE PLANCHE DE RIVE 	2	18x120	5510
KL4	LENGTHENING BOLT FOR TREADED ROD - VERLÄNGERUNGSMUTTER FÜR GEWINDESTANGE - MANCHON DE RACCORDEMENT DE TIGE FILETÉE 	4		
KL1	DRIVE NUT TREADED ROD - EINSHLAGMUTTER FÜR GEWINDESTANGE - ÉCROU A FRAPPER POUR TIGE FILETÉE 	4		
KL2	NUT FOR TREADED ROD - MUTTER FÜR GEWINDESTANGE - ÉCROU POUR TIGE FILETÉE 	4		
KL3	PLAIN WASHER TREADED ROD - UNTERLEGSCHIEBE FÜR GEWINDESTANGE - RONDELLE PLATE POUR TIGE FILETÉE 	4		
HS83	SCREW FOR FIXING FILLET - SCHRAUBEN FÜR FIXIRUNGSLEISTE - VIS POUR PROFIL DE FIXATION 	26	3.5x50	
HS32	SCREW FOR EAVES BOARDS - SCHRAUBEN FÜR TRAUFBRETT - VIS DE FIXATION POUR BANDEAU DE TOIT 	56	3.5x50	
HS84	SCREW FOR FIXING FILLET - SCHRAUBEN FÜR FIXIRUNGSLEISTE - VIS POUR PROFIL DE FIXATION 	72	3.5x50	
HS16	SCREW FOR GABLE MOULDING - SCHRAUBEN FÜR GIEBELLEISTE - VIS DE FIXATION POUR PLANCHE DE RIVE 	66	3.5x50	
HS38	SCREW FOR FIXING TERRACE RAILING - SCHRAUBE FÜR TERRASSE VIS DE FIXATION DE GARDE-CORPS DE TERRASSE 	10	4.5x80	
HS45	SCREW FOR SLIDING WALL TIE - SCHRAUBEN FÜR WAND SCHIEBEREGLER SCHIEBEREGLER - VIS POUR FIXATION ÉQUERRE MÉTALLIQUE AU PARAVENT 	16	4x20	
NFD	SCREW FOR ROOFING FELT FILLET - SCHRAUBEN FÜR DACHPAPPENLEISTE VIS POUR BAGUETTE FIXATION FEUTRE BITUMEUX 	42	4x40	
HS34	SCREW FOR POST - SCHRAUBEN FÜR PFOSTEN - VIS DE FIXATION DES POTEAUX 	4	4x60	
HS40	SCREW FOR 1. WALL BEAM - SCHRAUBE FÜR 1. BOHLENREIHE - VIS DE FIXATION DES FONDATIONS 	12	5x120	
HS39	SCREW FOR FUNDAMENT - SCHRAUBEN ZUR BEFESTIGUNG FUNDAMENT - VIS POUR FONDATION 	64	5x120	

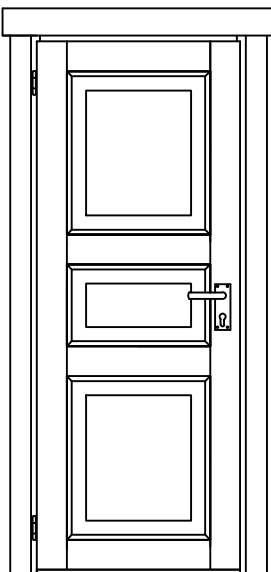
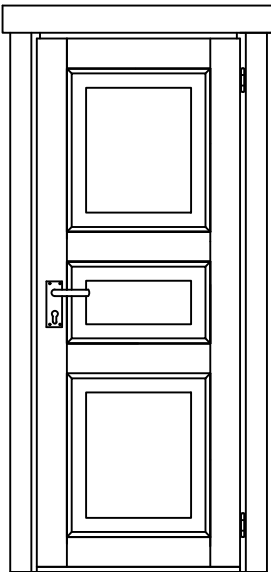
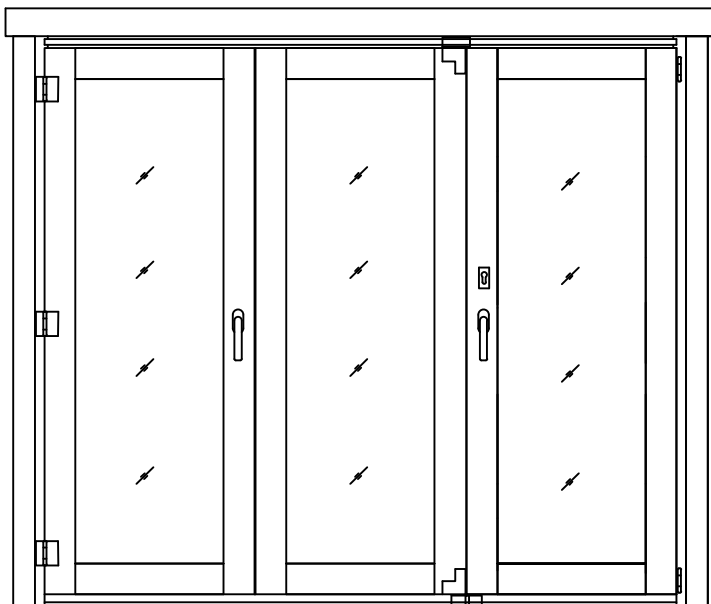
Pos	Exeter 1 - Art.No.7012202 Piece list - Stückliste - Liste des pieces	Q.	P (mm)	L (mm)
TRR2	TERRACE RAILING - TERRASSE - GARDE-CORPS DE TERRASSE 	2	910	1932
2+ A .0P.b	WINDOW-FENSTER-FENETRE 552x1729 	2		
2+ A .0P.h	WINDOW-FENSTER-FENETRE 510x510 	1		
2+ A .0V.b	WINDOW-FENSTER-FENETRE 552x1729 	1		
2+ A.0Ü	WINDOW-FENSTER-FENETRE 1500x510 	1		

Pos	Exeter 1 - Art.No.7012202 Piece list - Stückliste - Liste des pieces	Q.	P (mm)	L (mm)
U.3TV	DOOR-TÜR-PORTE 827x1933 NB! +LPL 	1		
U.3TP	DOOR-TÜR-PORTE 827x1933 NB! +LPL 	1		
3+	DOOR-TÜR-PORTE 2600x2000   <p data-bbox="331 2237 1499 2344"> General installation instructions - Allgemeine aufbauanleitung - Consignes générales de montage - Istruzioni per l'assemblaggio - Algemene opbouwhandleiding - Üldine püstitusjuhend http://www.orthez.ee/Folding_new.mp4 </p>	1		

LPL - only for inside doors

OP1 Only double door
Doppeltür
Seulement double porte

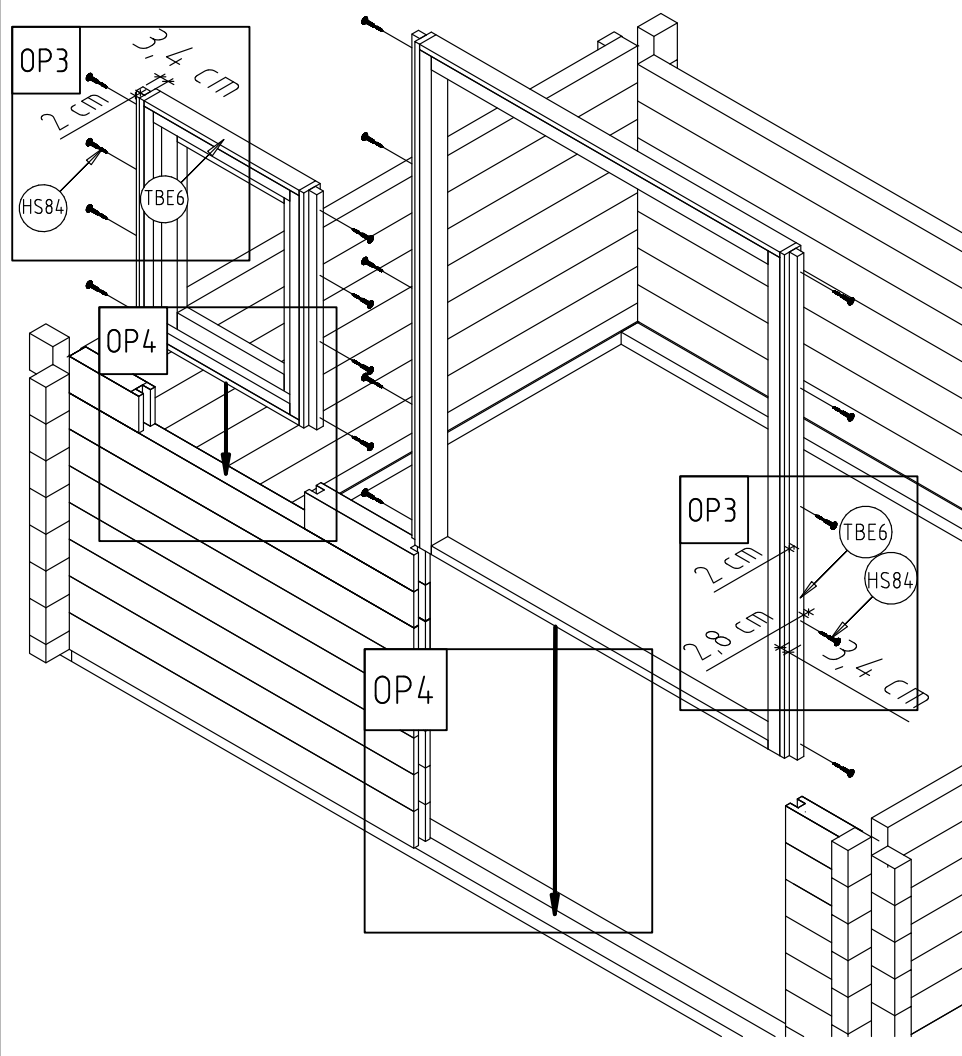
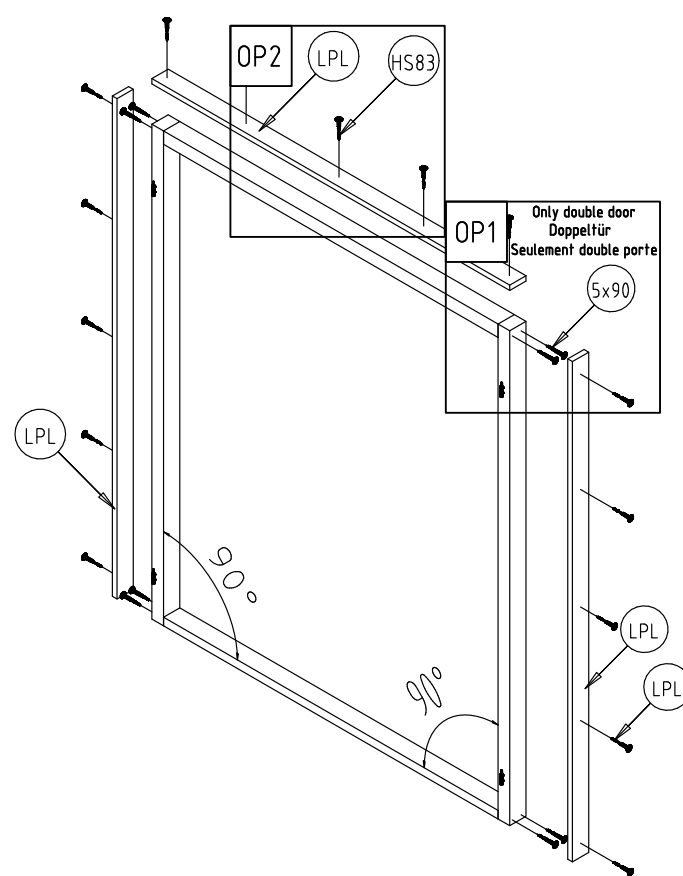
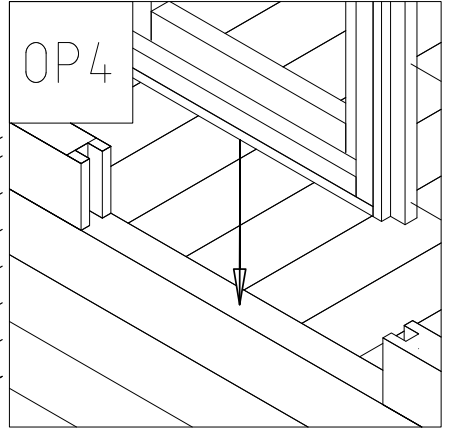
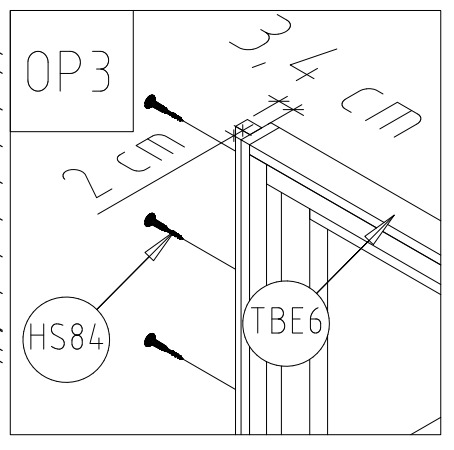
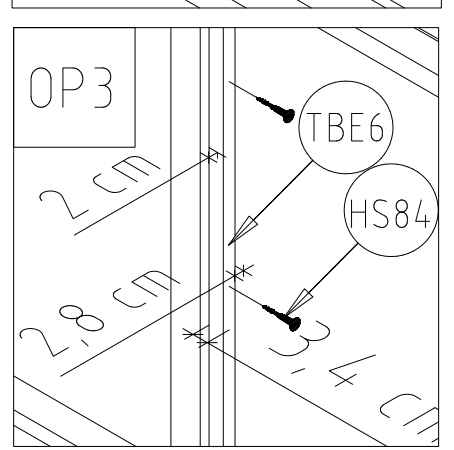
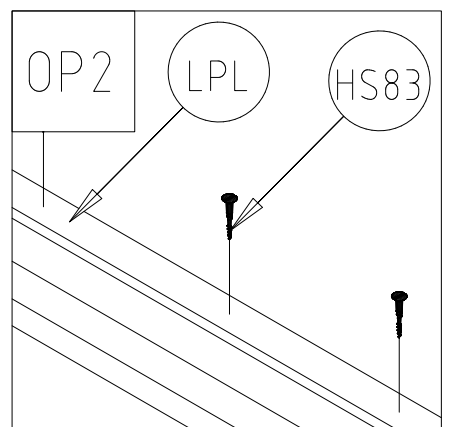
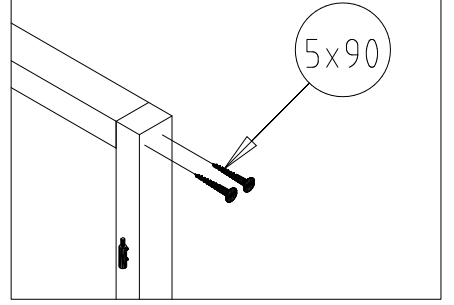

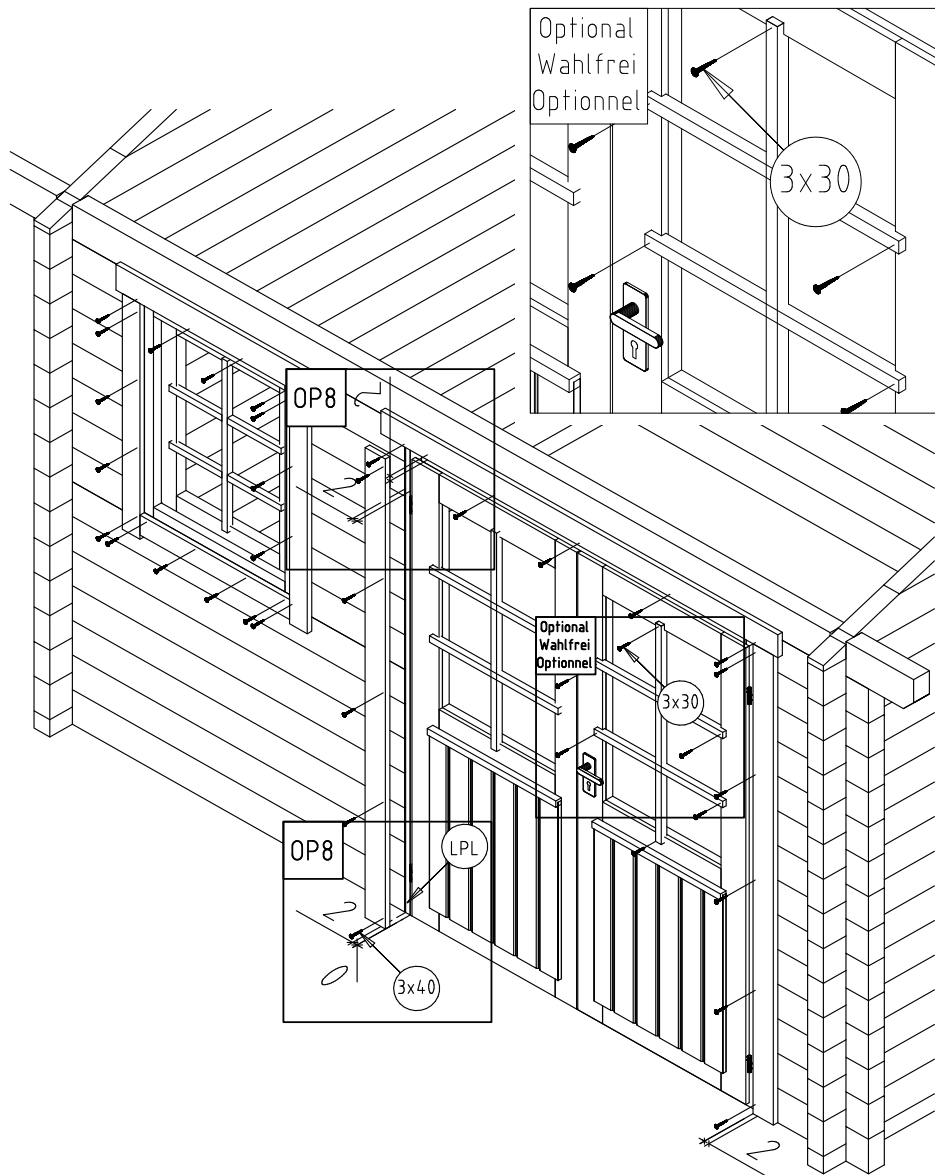
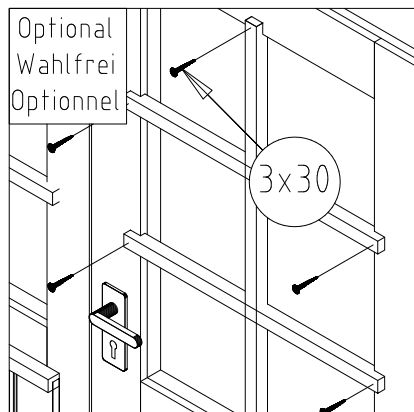
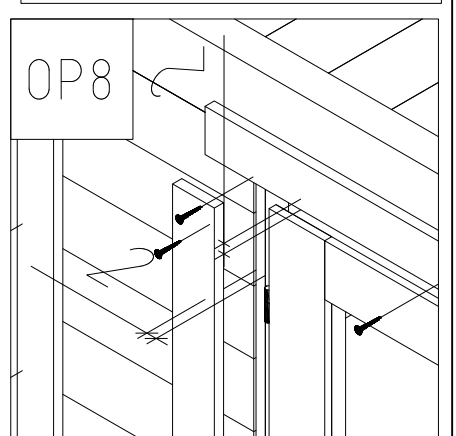
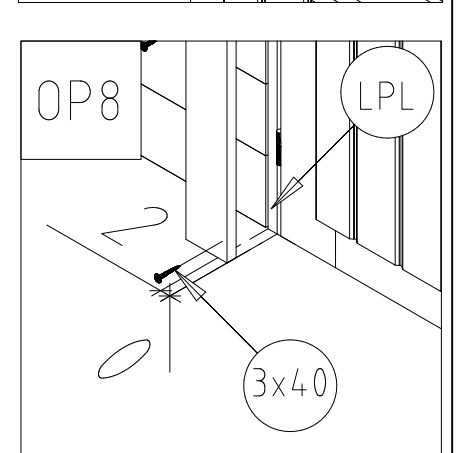
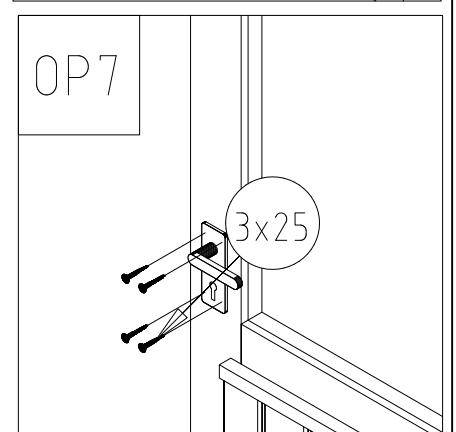
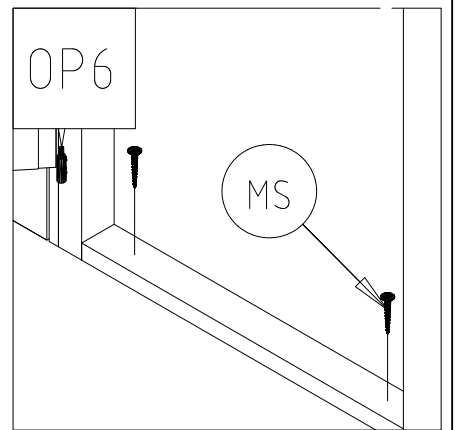
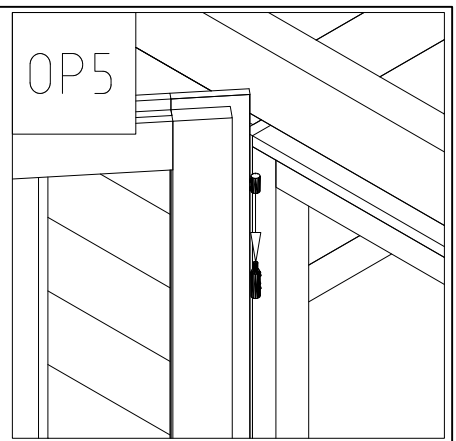
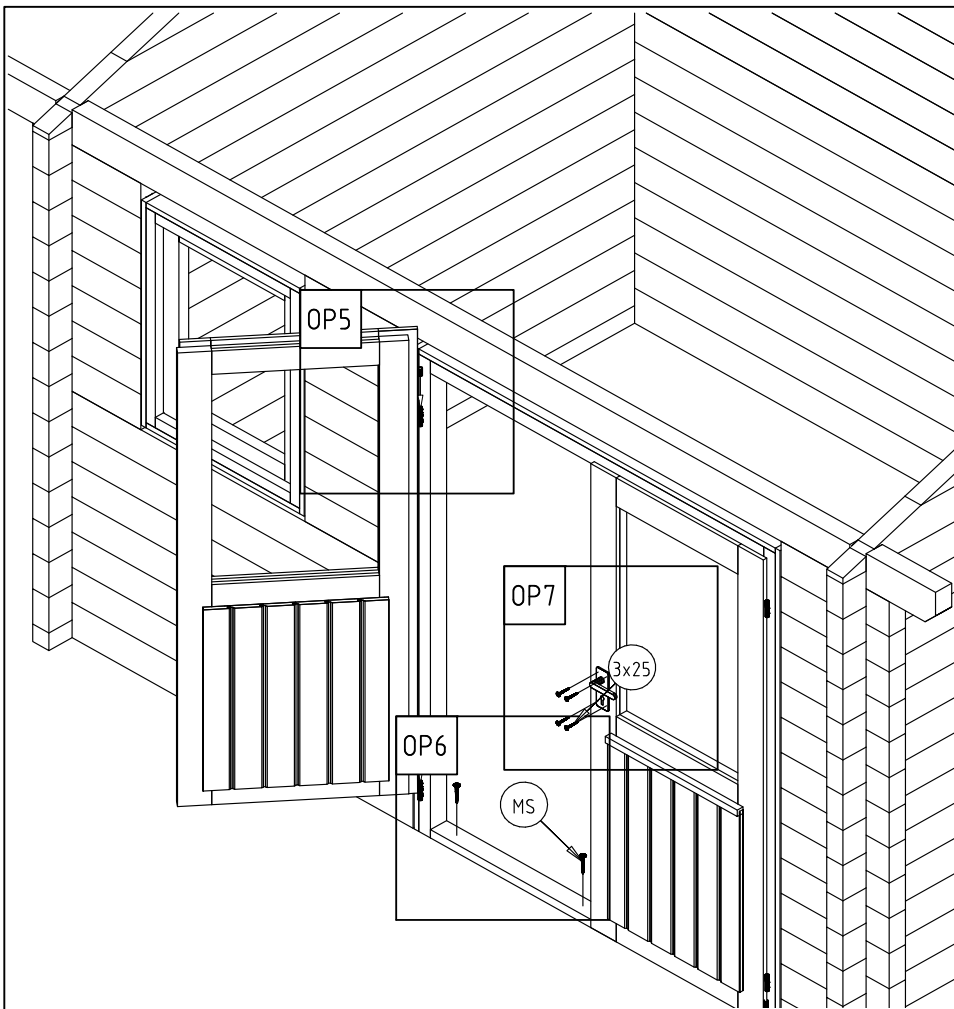

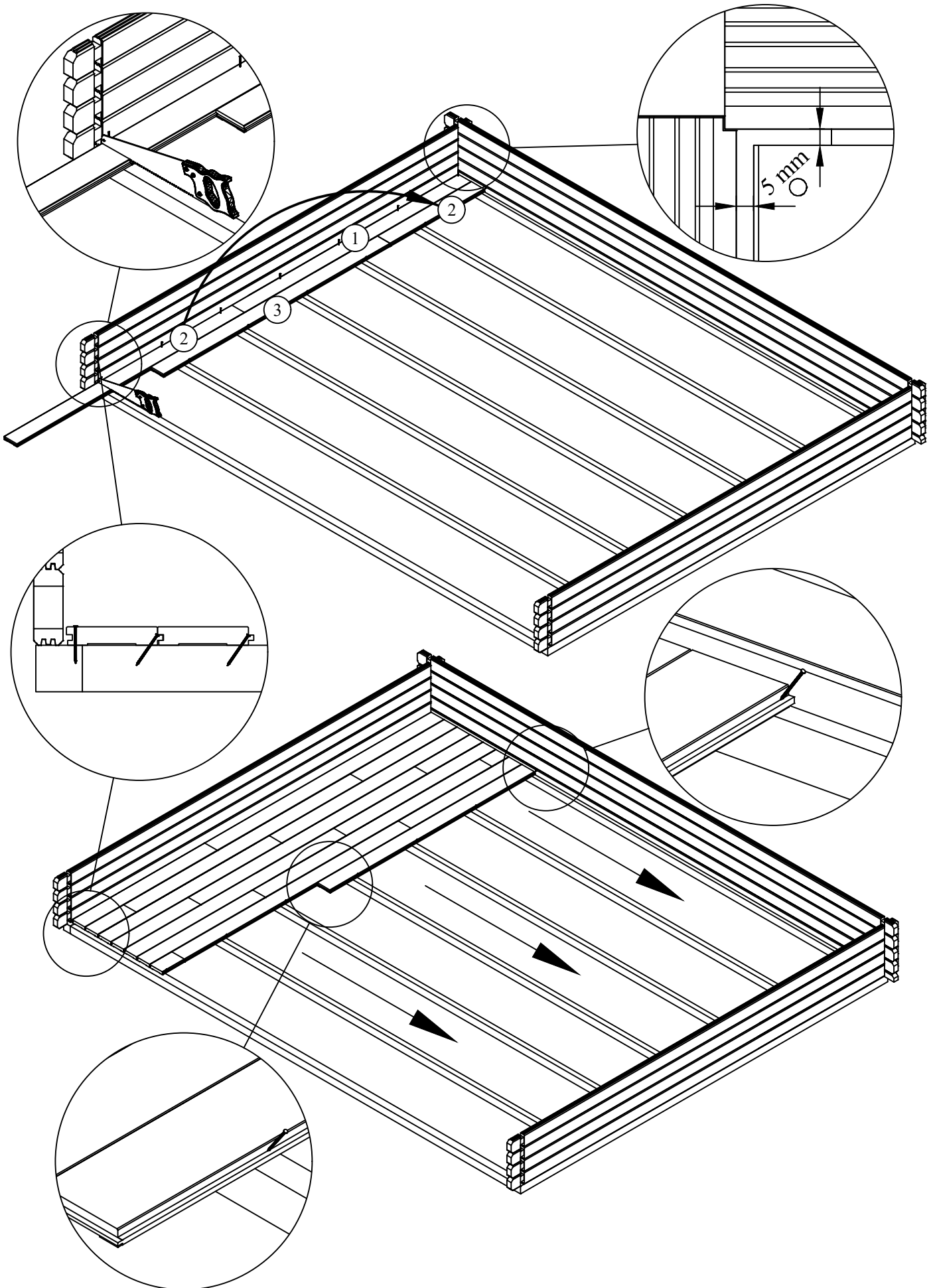

3 DOOR BIFOLD DOOR SET

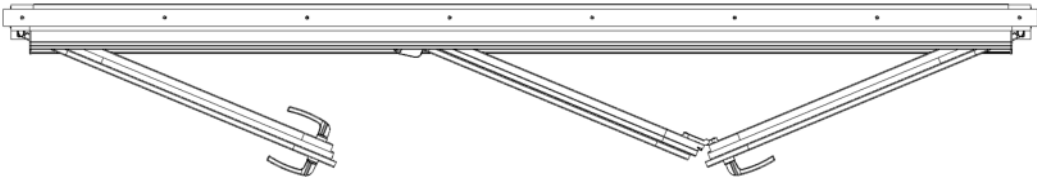

Hardware

A. 6 x 140 mm Screw x 10



B. 3,5 x 40 mm Screw x 54



C. Plastic push x 6

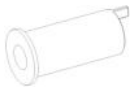

D. Upper guide roll x 1



E. Lower guide roll x 1

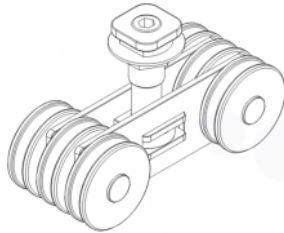

F. Lock set

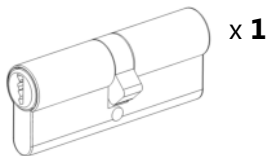
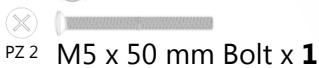

G. Open-end spanner SW17 x 1



H. Plastic cover x 1

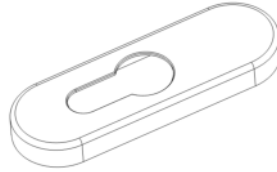

I. CB rosette inside x 1

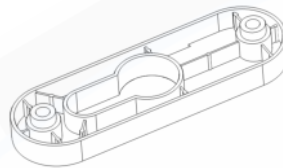
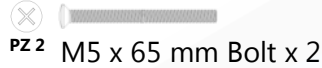

J. CB rosette outside x 1

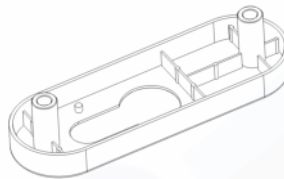

K. Cover cap x 3



L. Cover cap x 3

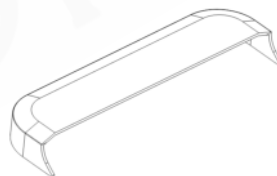

M. Cover cap for stay hinge x 2



Pins (x 5) are pre-installed



N. Cover cap for stay bearing x 2

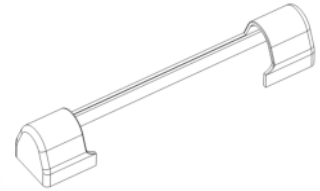

O. Cover cap x 1 RH + x 1 LH



P. Cover cap for pivot rest x 2



R. Turn handle x 1

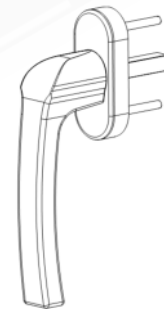

S. Turn handle set

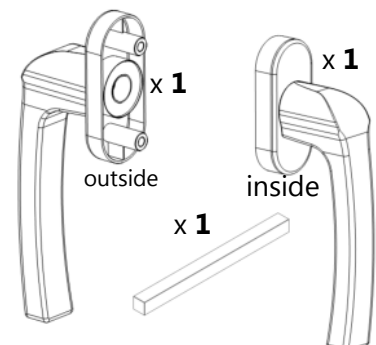
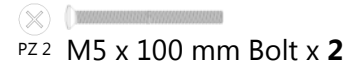

Parts list

LH
x 1

RH
x 1

x 4

x 2



x 1

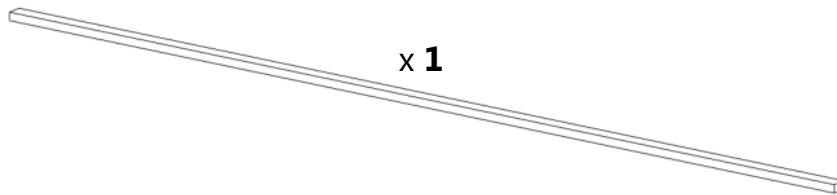

x 1

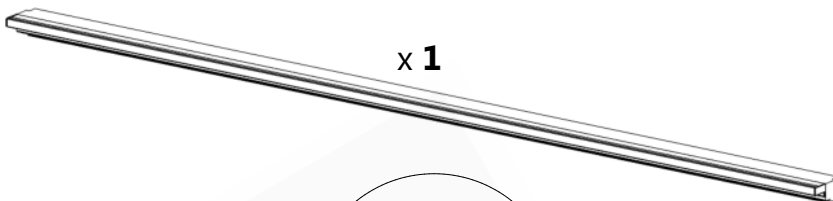

TOP

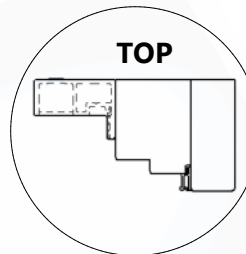

x 1



BOTTOM

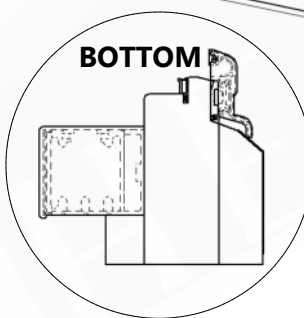

x 1

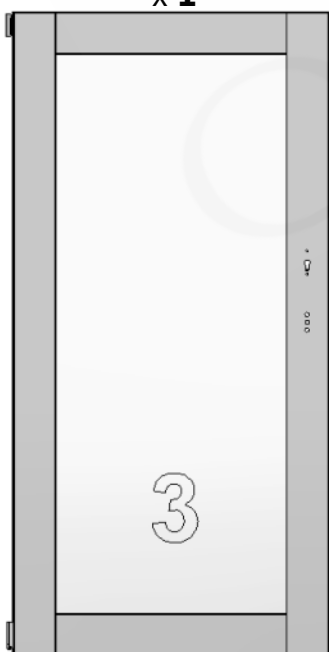

x 1

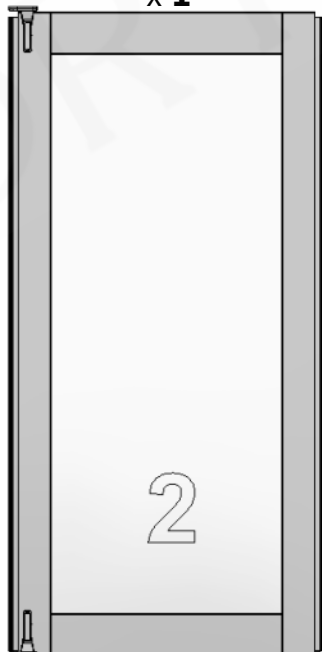

x 1

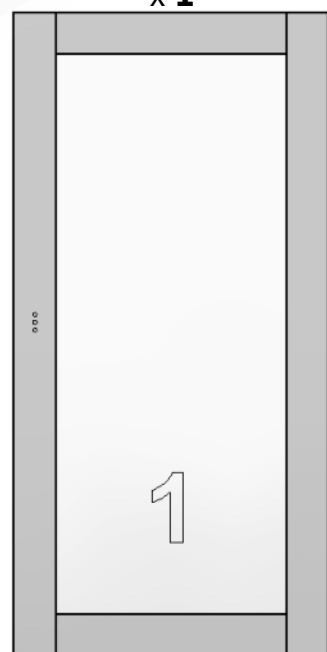

Door frame assembling



□ Lay the 4 pcs of frame parts on the floor on top of cardboard or a similar protective material to prevent damage to the parts.

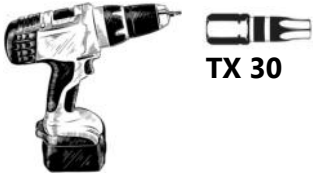

TX 30

Tools not supplied!

A. 6 x 140 mm Screw x 10

Step 1

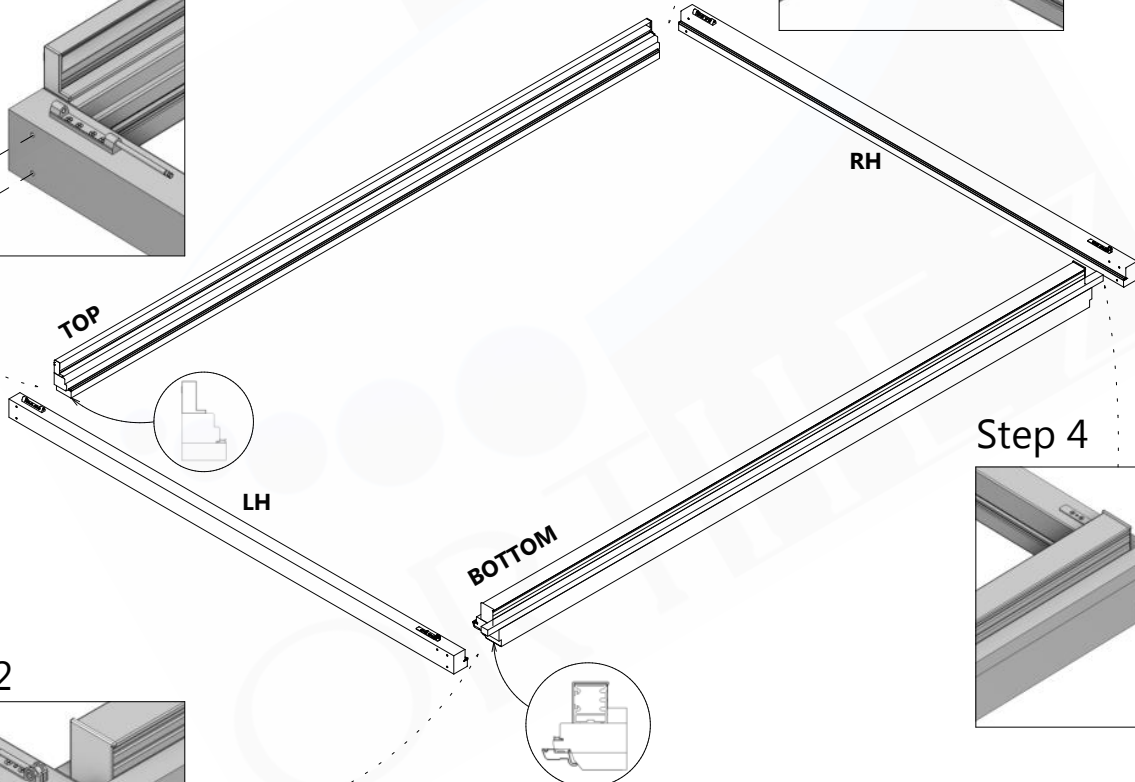
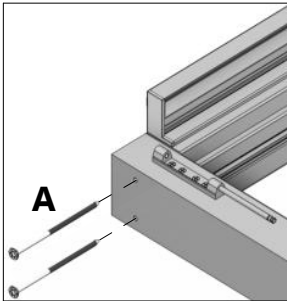

Step 3

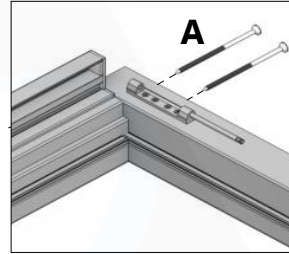

Step 4

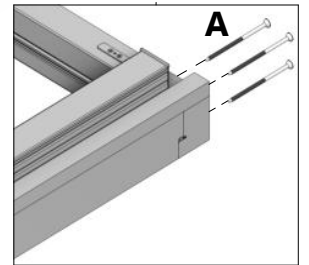

Step 2

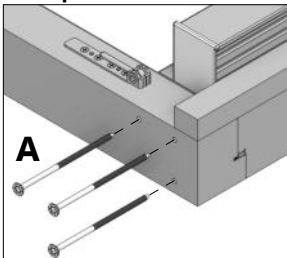

Door frame installation and sideboard fixing



Tools not supplied!

B. 3,5 x 40 mm Screw x 36

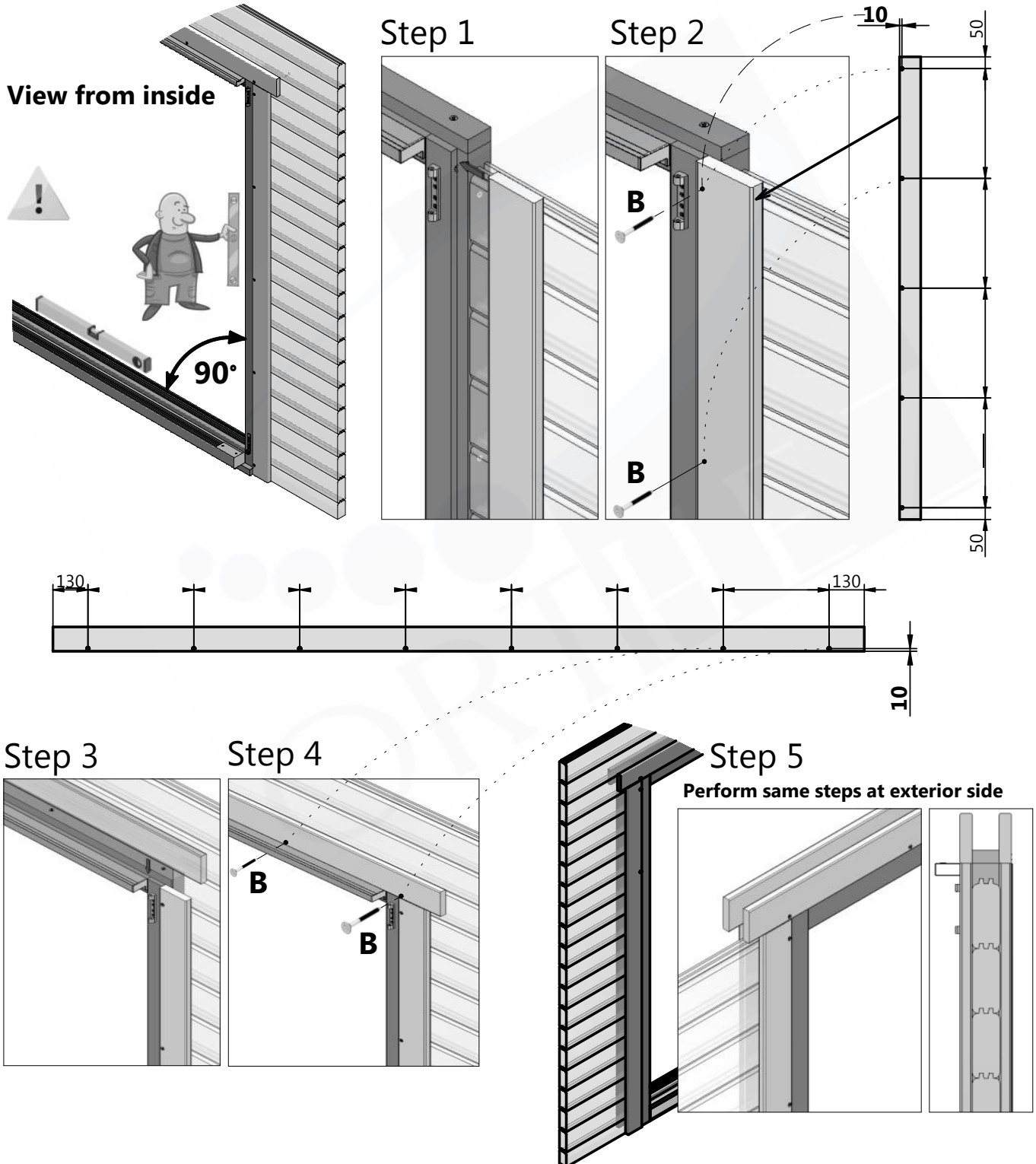

Door sash no. 1 installation



See the page 13

- adjustment of the Turn-Only hinge
- adjustment at the rebate corner hinge
- adjusting the pivot rest

View from inside

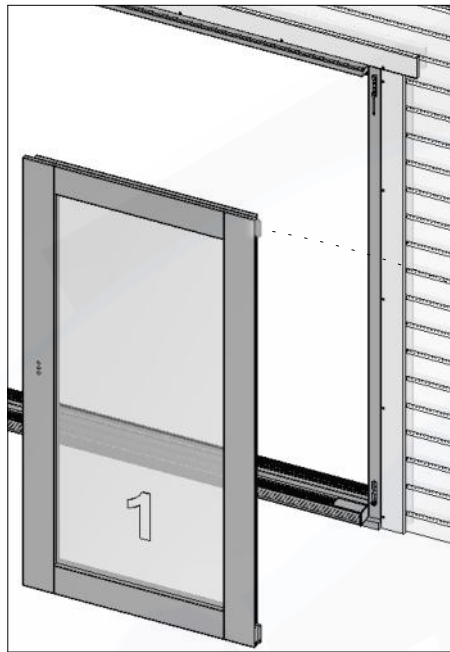
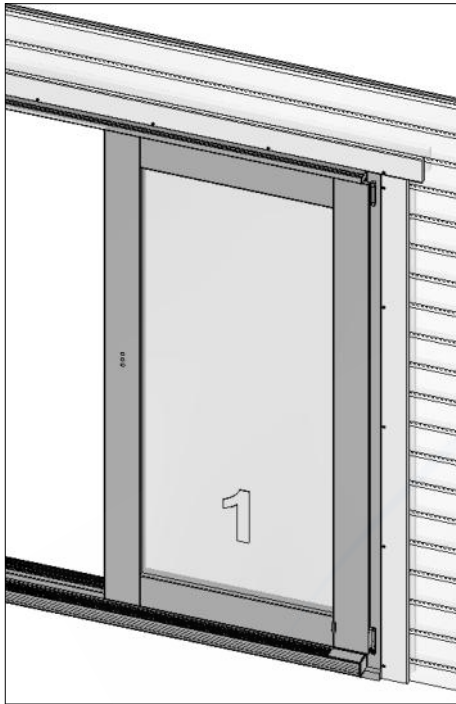

Step 1

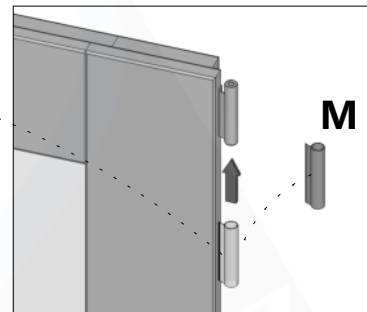

Step 2

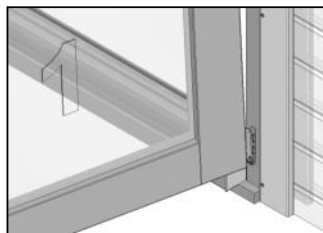
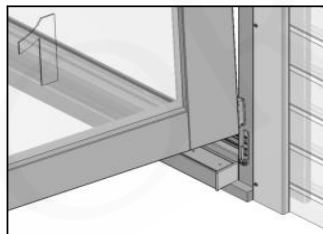
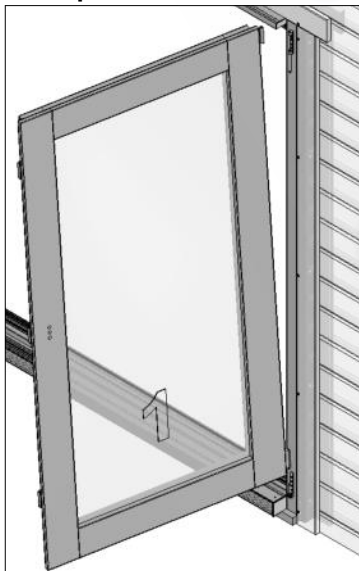

Step 3

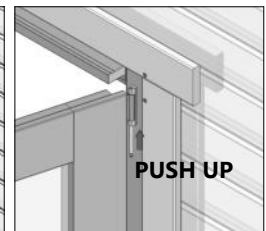

Door sash no. 2 installation



See the page 13

- adjusting the fold and slide hinge
- see additional document *"Installation, operating and maintenance instructions"*

View from outside

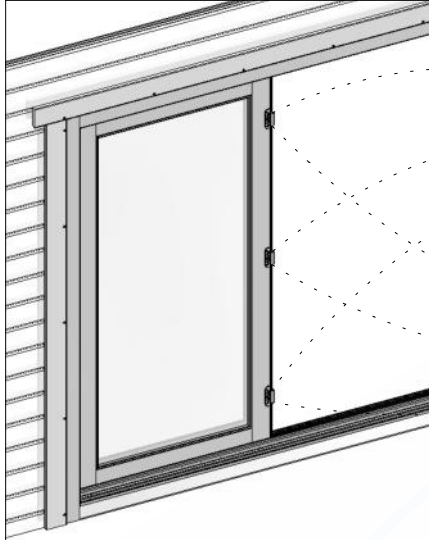

Step 1

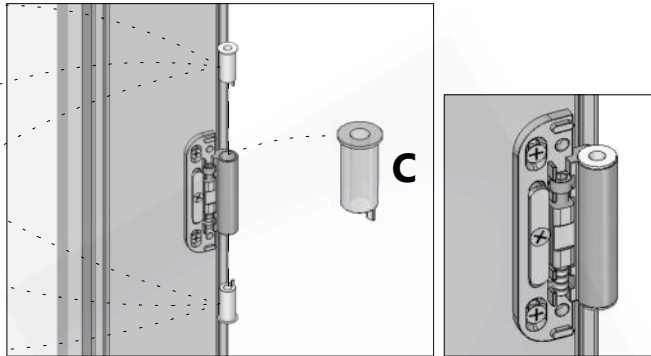

Step 2

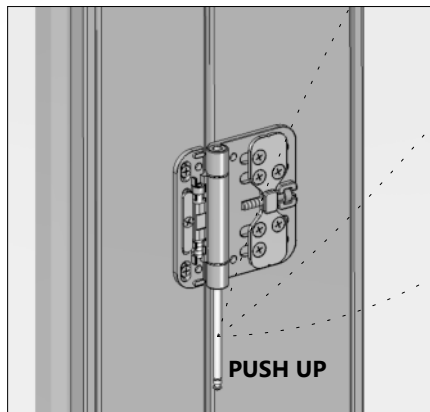
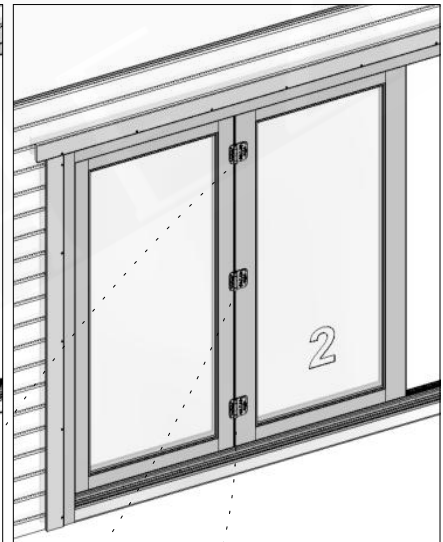

Door sash no. 2 installation continued



See the page 13

- adjusting the bogie and guide roll
- see additional document *"Installation, operating and maintenance instructions"*

View from inside

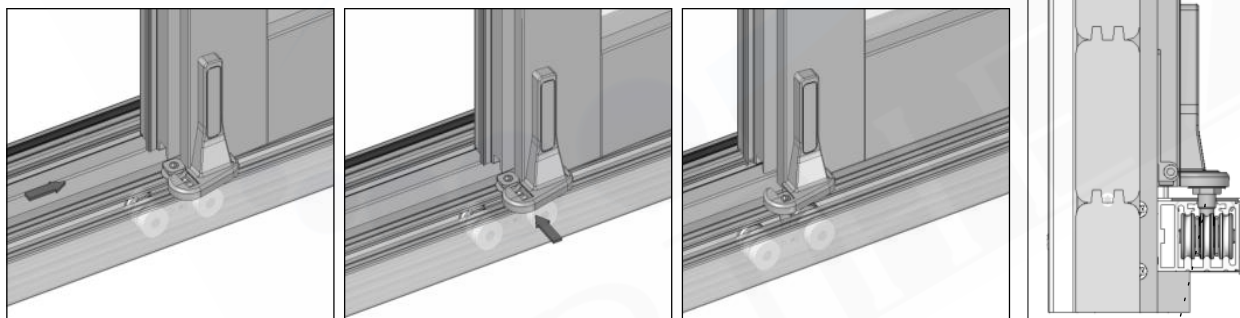
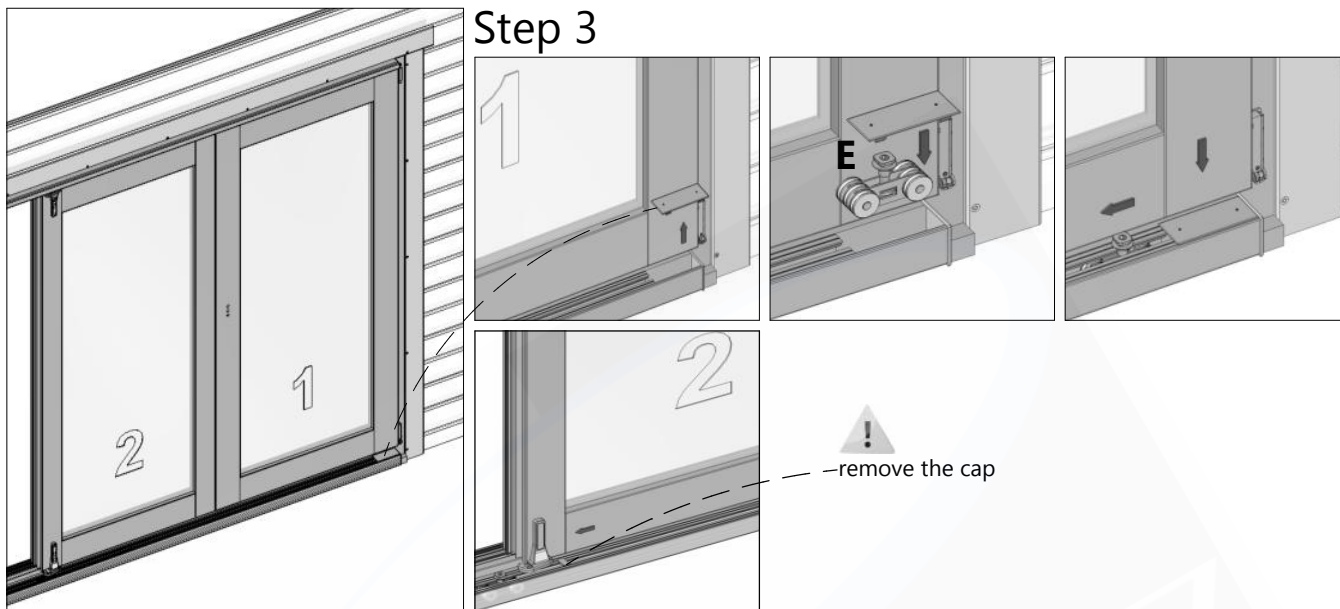

Step 4

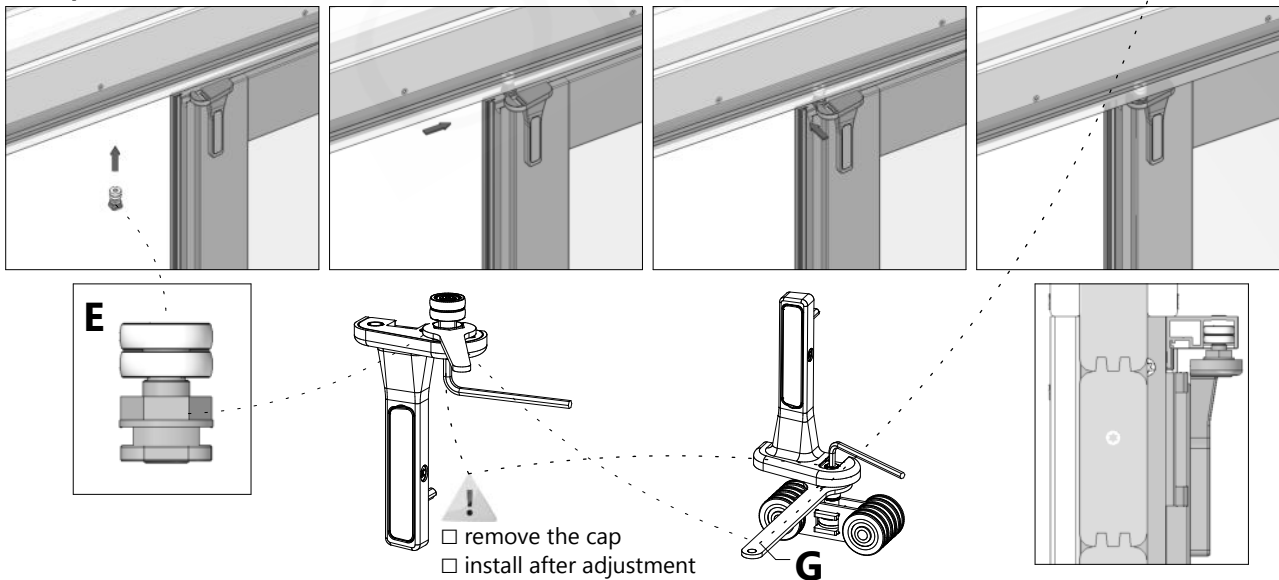

Door sash no. 3 installation



See the page 13

- engaging and disengaging the stay
- adjusting the stay
- adjustment at the rebate corner hinge
- adjusting the pivot rest

View from inside

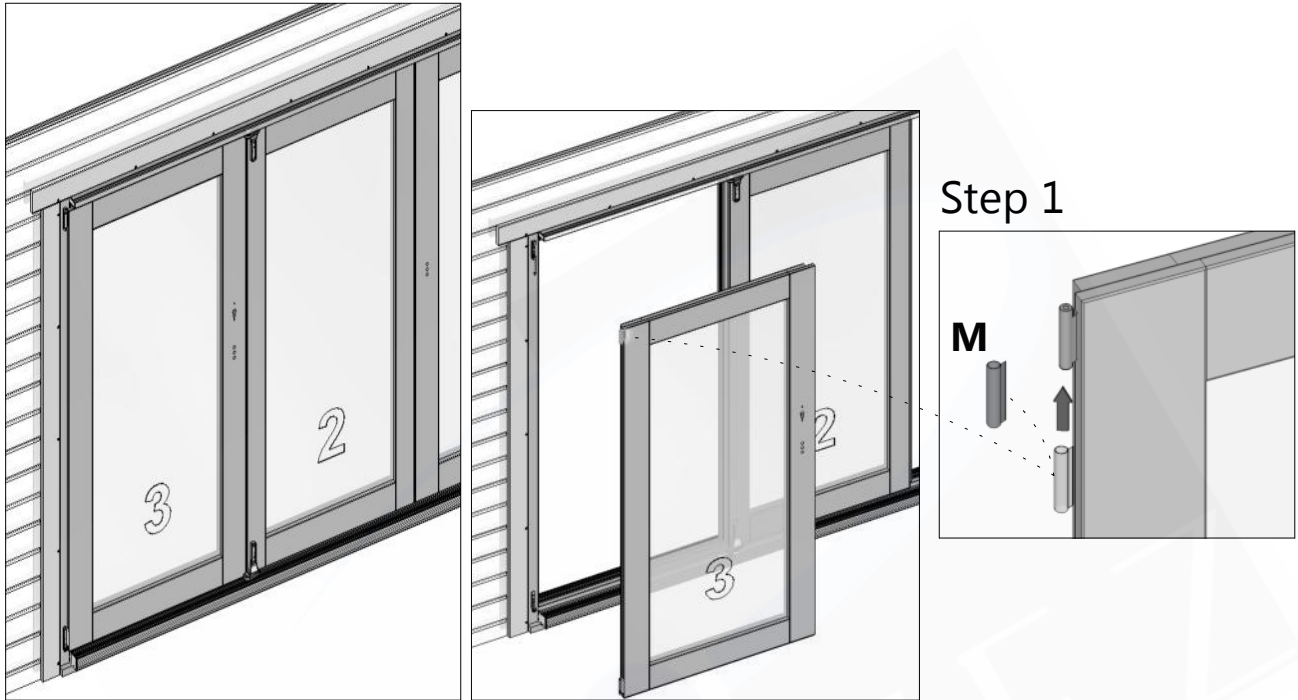

Step 2

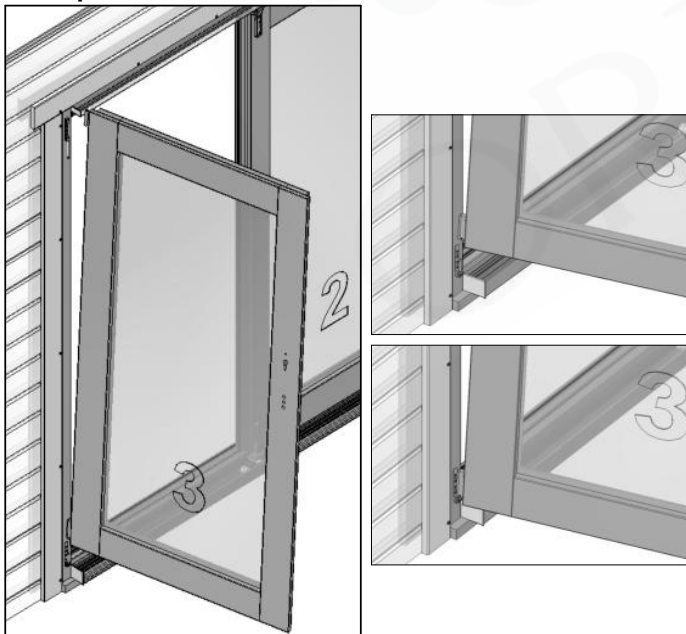

Step 3

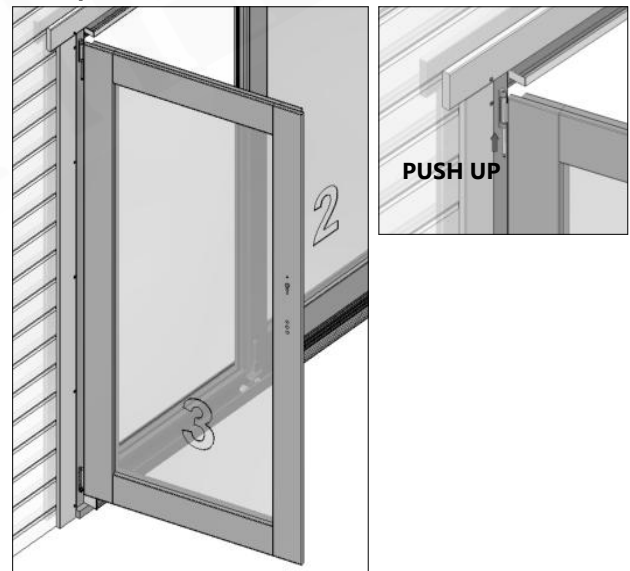

Door handles and lock set installation



Tools not supplied!

View from inside

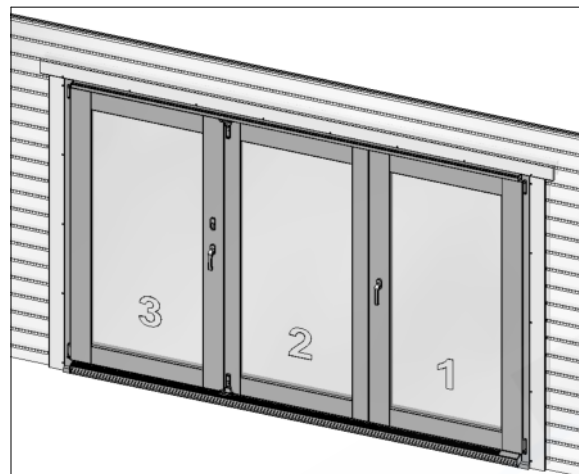

Step 1

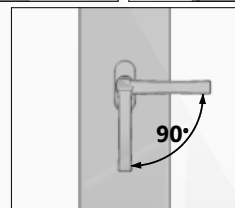
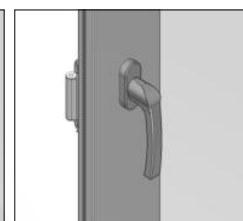
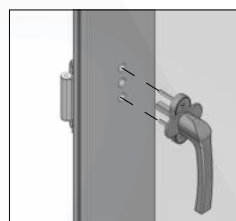
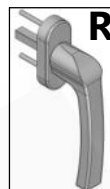
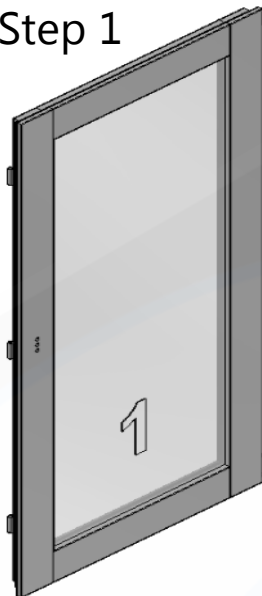

Step 2

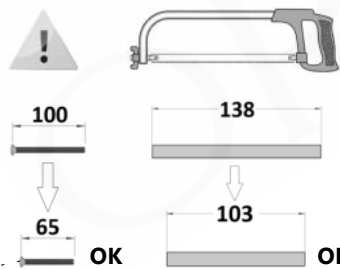
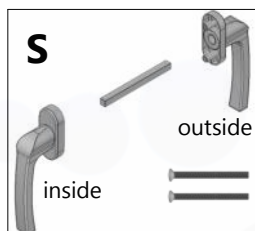

View from outside



Step 3

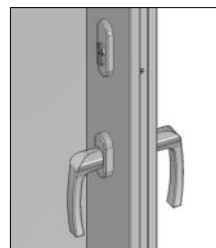
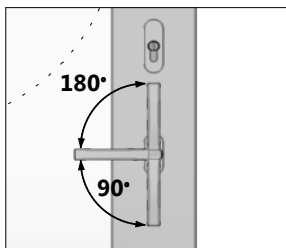
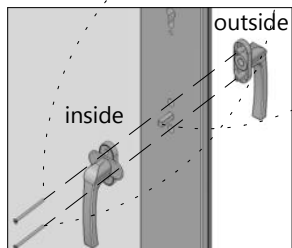
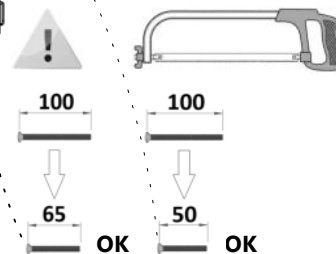
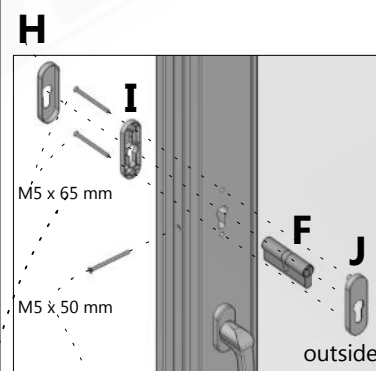

Cover caps installation

View from inside

Step 1

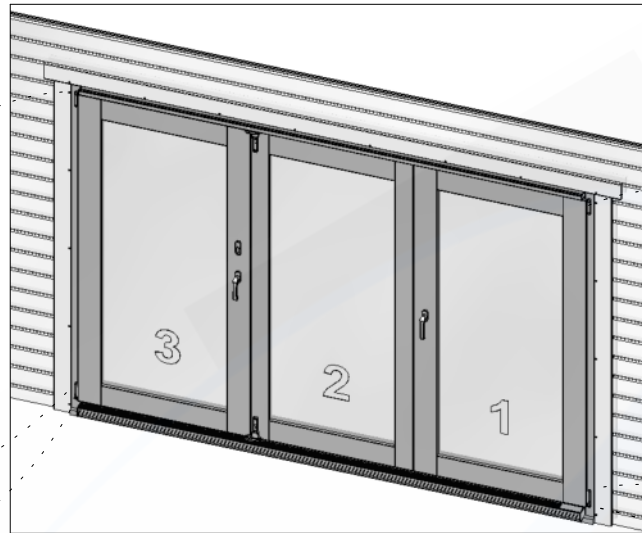
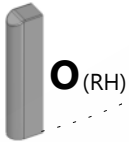
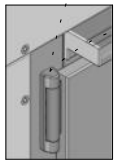
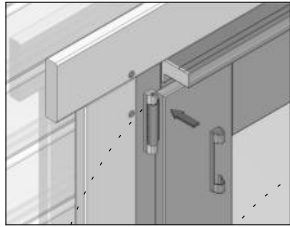

Step 2

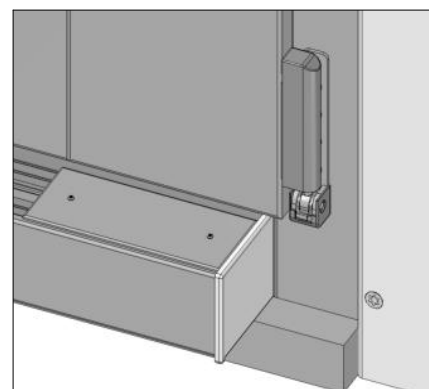
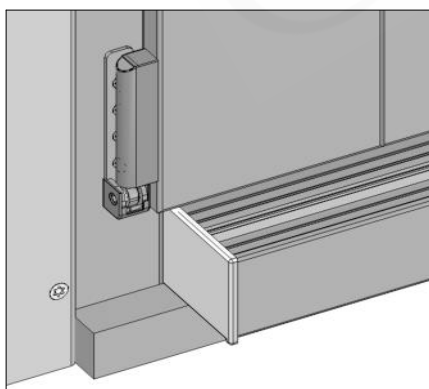
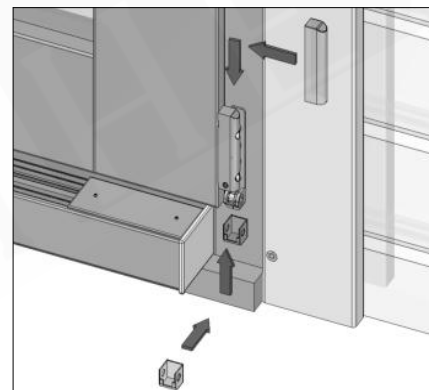
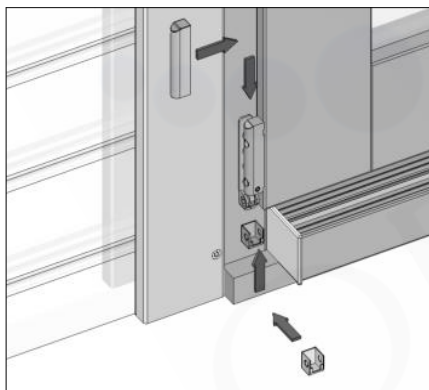
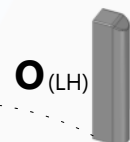
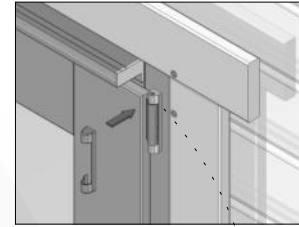

Hardware adjustment



Tools not supplied!

Engaging and disengaging the stay

Adjusting the stay
Setting + 3,5 mm / -3 mm
TX 15

Setting ± 1 mm
TX 15

Adjustment of the Turn-Only hinge

Setting ± 1 mm
TX 15

Setting + 3,5 mm / - 3 mm
TX 15

Adjusting the pivot rest

Setting ± 2 mm
TX 15

Adjustment at the rebate corner-hinge

Adjustable turn-brake

Setting ± 2 mm
SW 4

Setting ± 1 mm
TX 15

Adjusting the pivot rest

Setting ± 2 mm
TX 15

! See additional document
"Installation, operating and maintenance instructions"

Vertical adjustment on bogie / pivot rest

Loosening and adjusting

- Hold the set bolt using an allen key SW 4
- Loosen and hold the locknut using an open-end spanner size 17
- Adjust vertically with Allen key SW 4

Vertical adjustment
+3,5 mm / -1 mm
SW 4

Locking

- Hold the set bolt using an Allen key SW 4
- Firmly tighten locknut with open end spanner size 17

Adjusting the pivot rest

Setting ± 2 mm
TX 15

Vertical adjustment on bogie and guide roll

Loosening and adjusting

- Hold the set bolt using an allen key SW 4
- Loosen and hold the locknut using an open-end spanner size 17
- Adjust vertically with Allen key SW 4

Vertical adjustment
+3,5 mm / -1 mm
SW 4

Locking

- Hold the set bolt using an Allen key SW 4
- Firmly tighten locknut with open end spanner size 17

Loosen screws for vertical adjustment

SW 4

Loosen screws for horizontal adjustment

Fixing / removing the sash hinge cover

For attachment / removal of sash-hinge covers, the setscrews on the back must be tightened / loosened. Open sashes to access screws, if the F&S unit is already installed.

Cover caps installation



See the page 13

□ fixing / removing the sash-hinge cover

View from outside

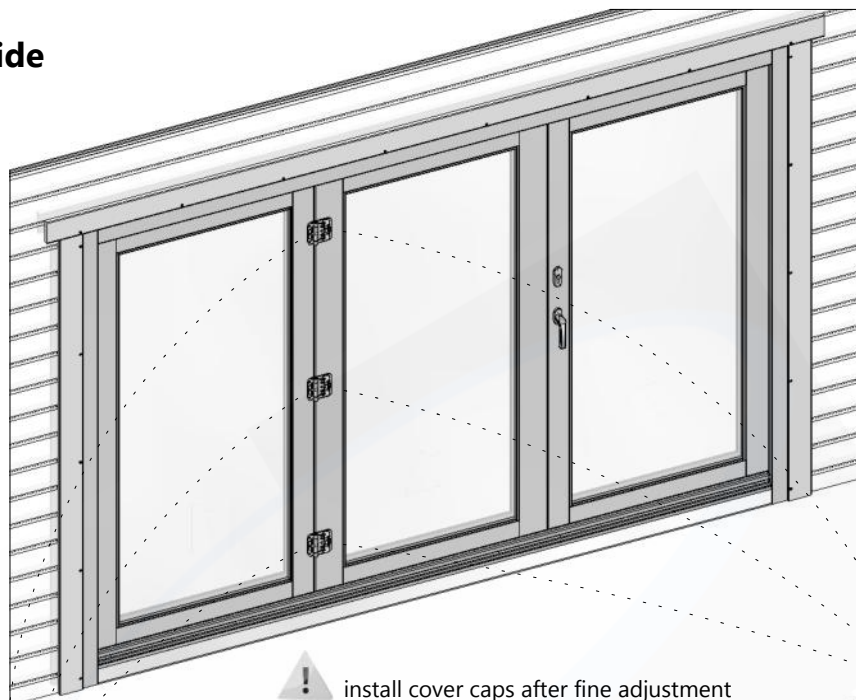

Step 1

! install cover caps after fine adjustment

Step 2

L

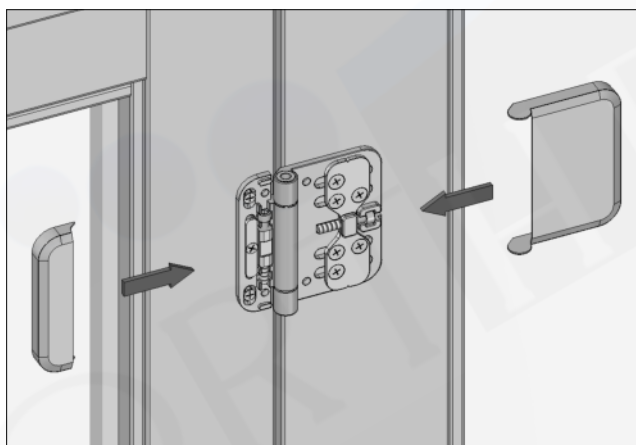

K

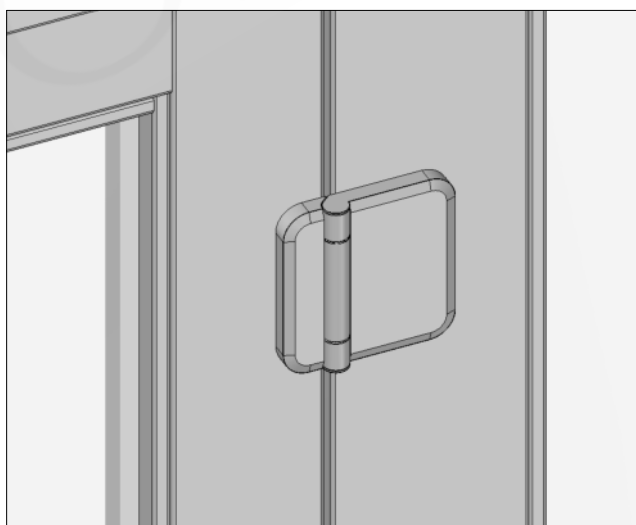
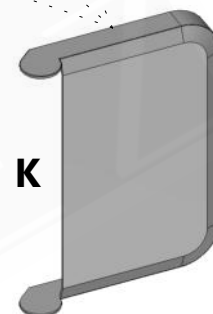

Operation of bifold doors



- First close doors 1 and 2, by turning the inside handle 90 degrees downwards so the doors then lock.
- Close door 3 by turning handle 90 degrees downwards, for locking turn the key clockwise.
Turn the handle 180 degrees to tilt-open door 3.
- Use door 3 independetly as a daily access door.

View from inside (inward opening)

