

Braunschweig
Art. Nr. 4432064
1/19

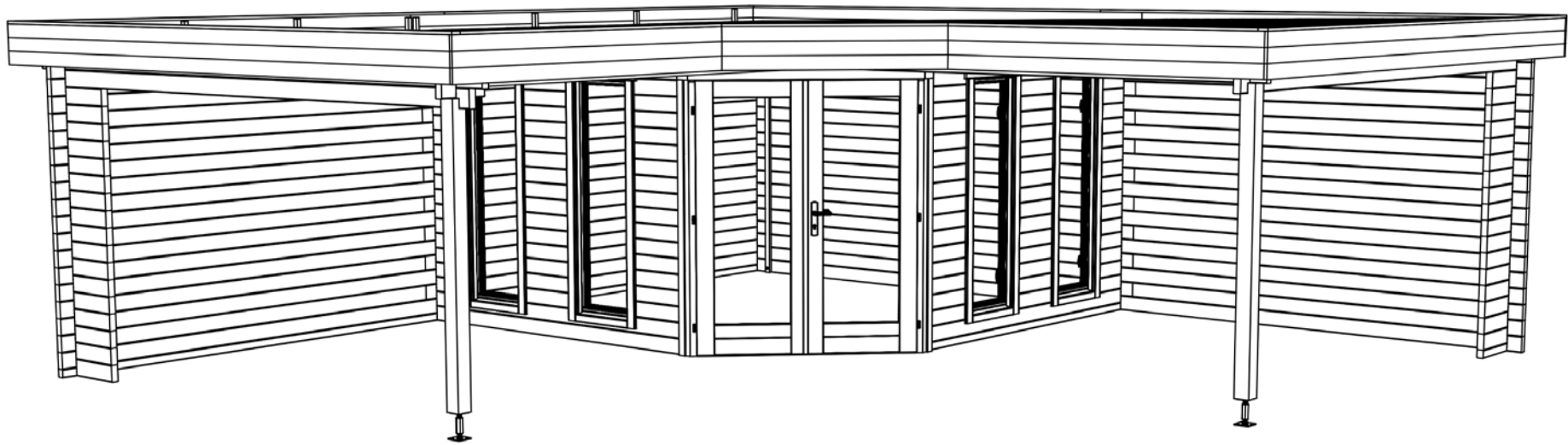

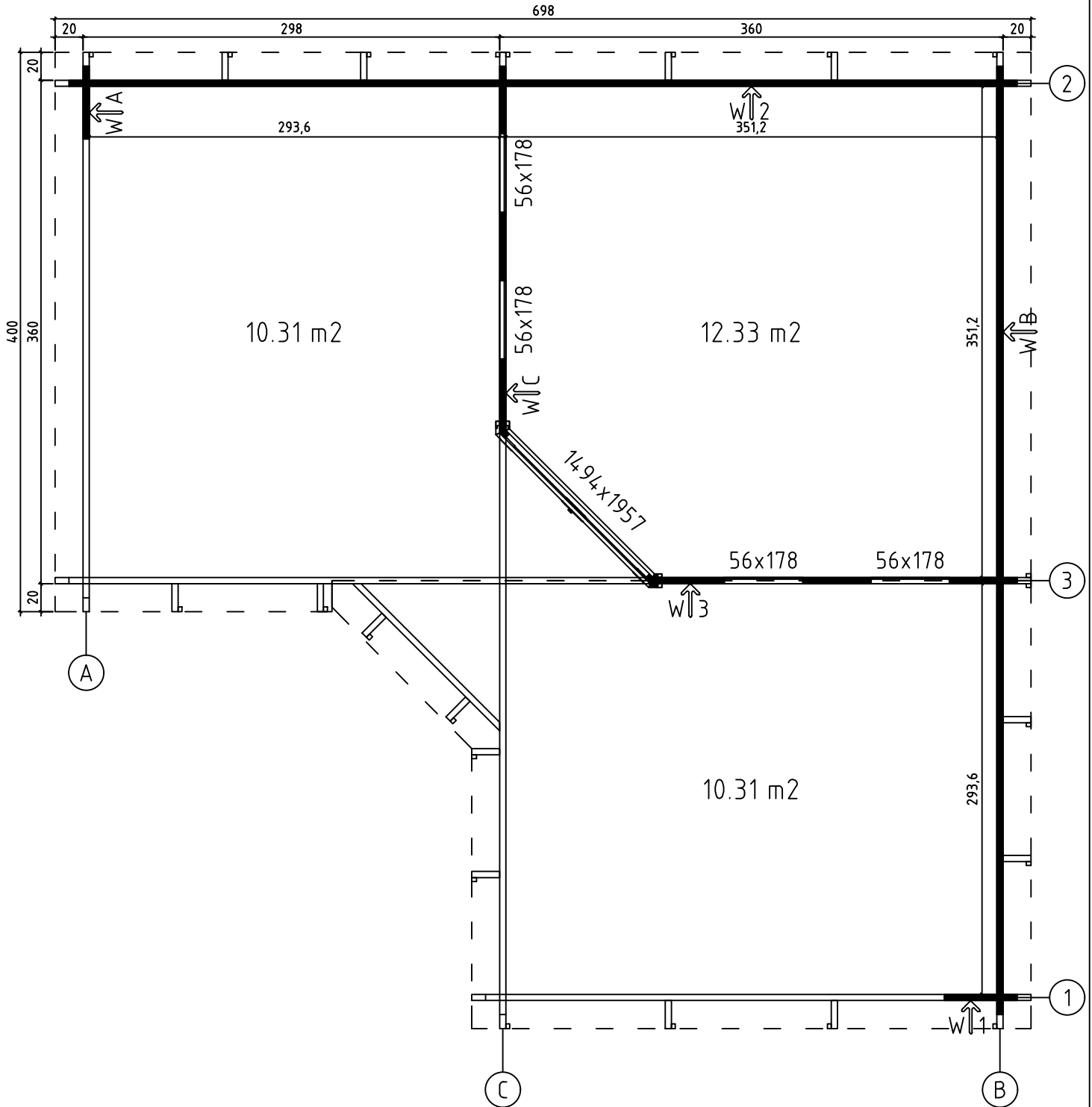



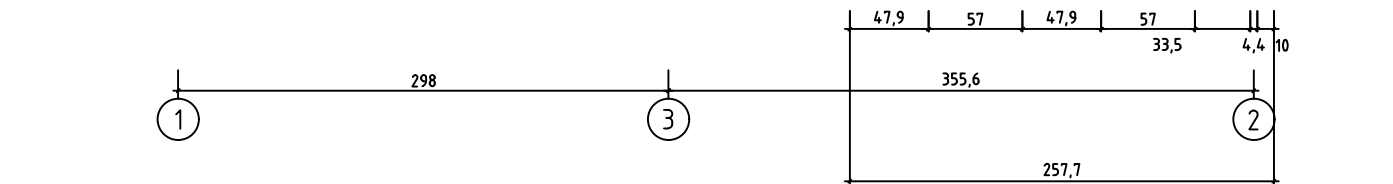
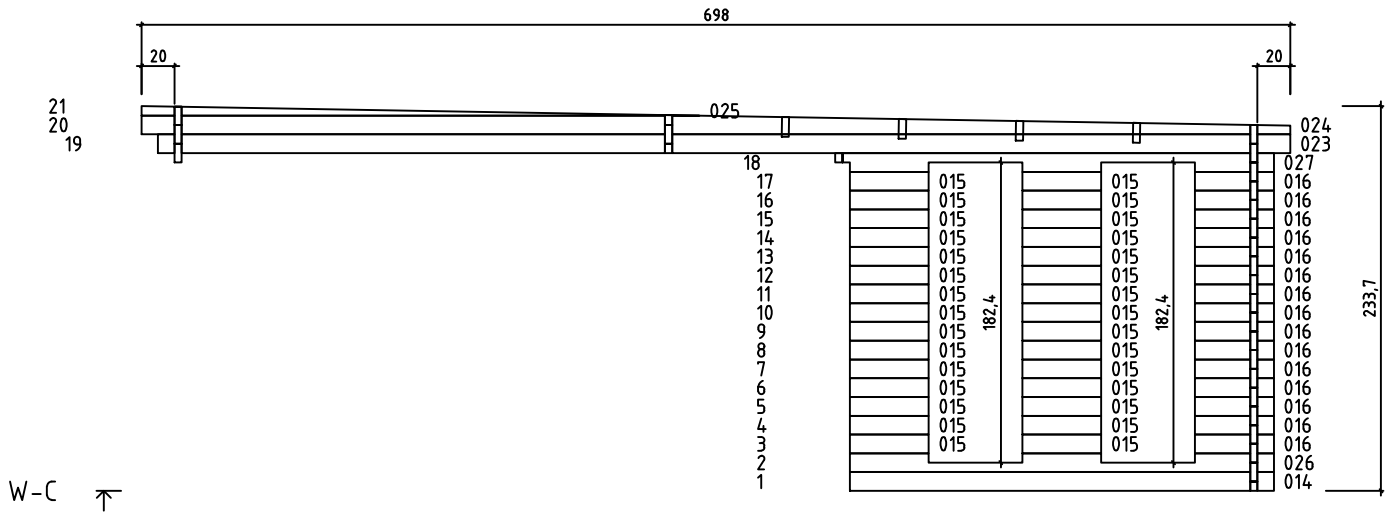
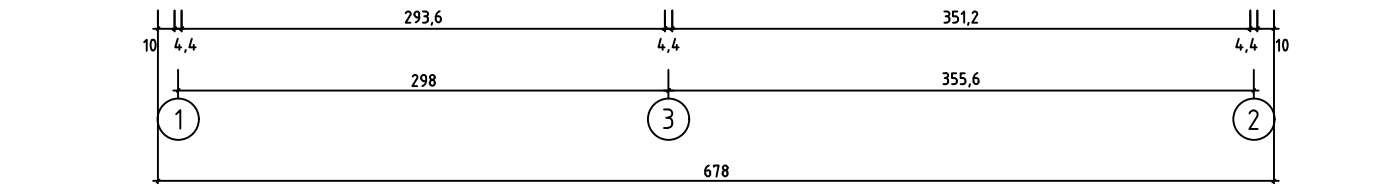
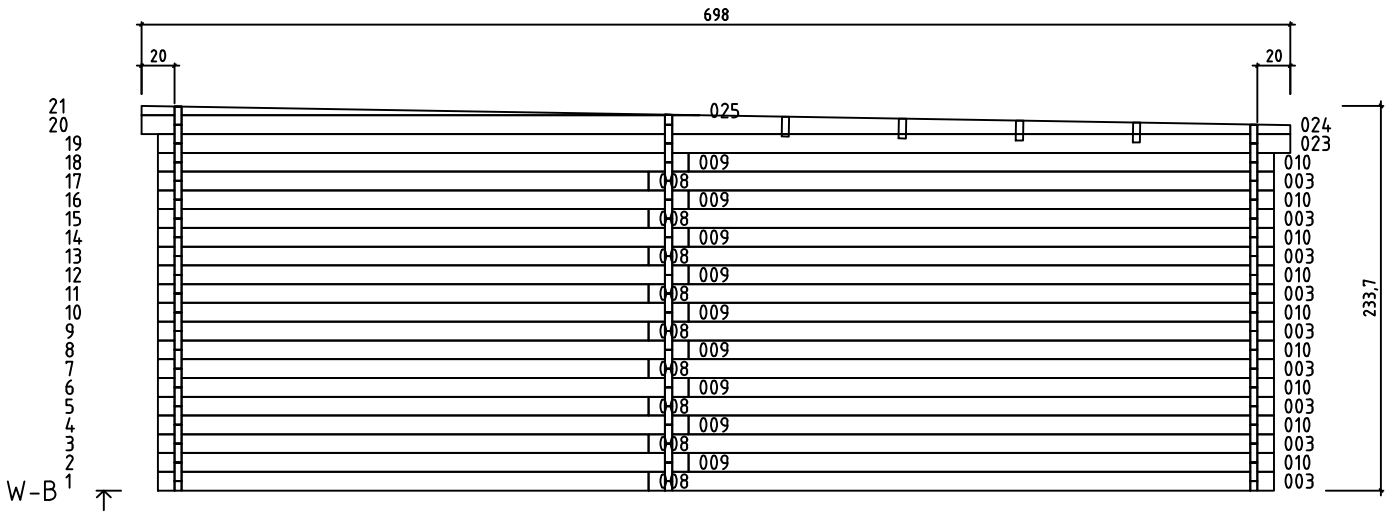

Art. Nr. 4432064

Groundplan - Grundplan - Plan de masse -
Planimetria - Plattegrond - Põhiplaan



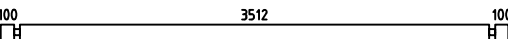
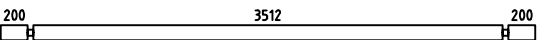
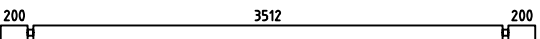
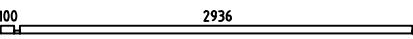
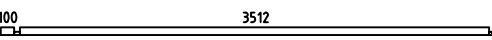
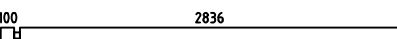
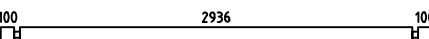
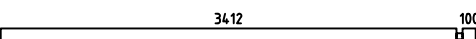
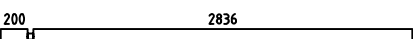
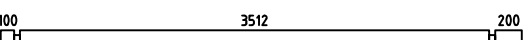
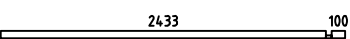
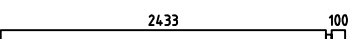

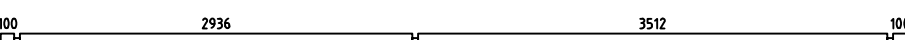
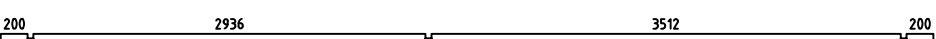
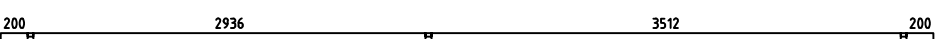
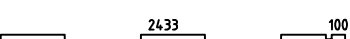
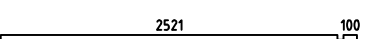

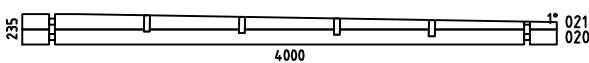



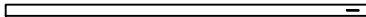

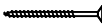
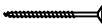

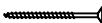
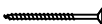
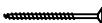
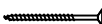

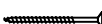

Art. Nr. 4432064

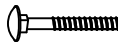

Pos	26.09.2023 Piece list - Stückliste - Liste des pièces - Elementi - Stuklijst - Tükítabel Art. Nr. 4432064 6/19	Q	P (mm)	L (mm)
001 46833		1	44x57	520
002 44155		34	44x114	520
003 22521		20	44x114	3800
004 46834		1	44x114	4000
005 46385		1	44x111	4000
006 46836		1	44x57	3102
007 31566		1	44x57	3678
008 46837		18	44x114	2980
009 46838		18	44x114	3224
010 31569		18	44x114	3556
011 46839		1	44x114	3080
012 46840		1	44x114	3900
013 46841		1	44x57	2577
014 46842		2	44x114	2577
015 46843		62	44x114	479
016 46844		31	44x114	479
017 46844		1	44x114	6780
018 46845		1	44x114	6980
019 46846		1	44x61	6980
026 46852		1	44x114	2577
027 46853		1	44x114	2665
028 46849		2	44x114	1489
WA-1 46854		1		

Pos	26.09.2023 Piece list - Stückliste - Liste des pièces - Elementi - Stuklijst - Tükítabel Art. Nr. 4432064 7/19	Q	P (mm)	L (mm)
WB-1 46855		1		
WC-1 46855		1		
A-PR3 46856	Roof beam - Dachbalken - Panne de toit - Perlina del tetto - Gordingen / dakbalk - Pärтин 	4	44x140	3828
A-PR2 46857	Roof beam - Dachbalken - Panne de toit - Perlina del tetto - Gordingen / dakbalk - Pärтин 	4	44x140	3252
A-PR1 46861	Roof beam - Dachbalken - Panne de toit - Perlina del tetto - Gordingen / dakbalk - Pärтин 	4	44x140	2926
RB1 32415	Roof boards - Dachbretter - Voliges - Perlina per tetto - Dakhout - Katuselaud	15	90x18	5000
RB2 40899	Roof boards - Dachbretter - Voliges - Perlina per tetto - Dakhout - Katuselaud	23	90x18	4000
RB3 23133	Roof boards - Dachbretter - Voliges - Perlina per tetto - Dakhout - Katuselaud	23	90x18	3900
RB4 46858	Roof boards - Dachbretter - Voliges - Perlina per tetto - Dakhout - Katuselaud	57	90x18	3678
CS 46862	Roof element - Dachelement - Panneau de toit prémonté - Componente del tetto - Dakelement - Katusekilp	1	1399x941	
RFF1 1598	Roofing felt fillet - Dachpappenleiste - Baguette de fixation du feutre bitumeux - Asse per fissaggio guaina bituminosa - Afdeklijst asfaltpapier - Katusepapiliist	1	18x58	1350
RFF2 2015	Roofing felt fillet - Dachpappenleiste - Baguette de fixation du feutre bitumeux - Asse per fissaggio guaina bituminosa - Afdeklijst asfaltpapier - Katusepapiliist	2	18x58	2050
RFF3 21714	Roofing felt fillet - Dachpappenleiste - Baguette de fixation du feutre bitumeux - Asse per fissaggio guaina bituminosa - Afdeklijst asfaltpapier - Katusepapiliist	2	18x58	3450
RFF4 46863	Roofing felt fillet - Dachpappenleiste - Baguette de fixation du feutre bitumeux - Asse per fissaggio guaina bituminosa - Afdeklijst asfaltpapier - Katusepapiliist	2	18x58	3479
RFF5 46863	Roofing felt fillet - Dachpappenleiste - Baguette de fixation du feutre bitumeux - Asse per fissaggio guaina bituminosa - Afdeklijst asfaltpapier - Katusepapiliist	2	18x58	4036
P1 46864	Post - Pfosten - Poteau - Piede registrabile - Stijl - Post	1	90x90	1845
P2 35409	Post - Pfosten - Poteau - Piede registrabile - Stijl - Post	1	90x90	1915
TB1 46104	Fascia board - Traufbrett - Bandeau de toit - Finitura lati tetto - Gevellijst - Räästalaud	3	18x90	1350
TB2 32970	Fascia board - Traufbrett - Bandeau de toit - Finitura lati tetto - Gevellijst - Räästalaud	6	18x90	2100
TB3 46866	Fascia board - Traufbrett - Bandeau de toit - Finitura lati tetto - Gevellijst - Räästalaud	6	18x90	3202
TB4 46867	Fascia board - Traufbrett - Bandeau de toit - Finitura lati tetto - Gevellijst - Räästalaud	6	18x90	3796
TB5 46868	Fascia board - Traufbrett - Bandeau de toit - Finitura lati tetto - Gevellijst - Räästalaud	6	18x90	4018

Pos	Piece list - Stückliste - Liste des pièces - Elementi - Stuklijst - Tükítabel 26.09.2023 Art. Nr. 4432064 8/19	Q	P (mm)	L (mm)
KFS 27180	Storm protection - Sturmleiste - Latte anti-tempete - Protezione anti vento - Stormverankering / beveiliging - Tormikinnusliist 	6	22x45	2500
BF 982	Fixing slat for gable moulding - Befestigungsleiste - Renforts planches de rives - Stecca per fissare i distanziatori - Bevestigingslat afstandhouders - Viilulaua kinnitus 	22	28x34	250
DS 36130	Distance spacers for gable moulding - Dachstützen - Supports extension toiture - Distanziatori per la modanatura del timpano - Daksteun / afstand houder - Viilulaua tugiklots 	15	44x95	200
HS9 5106	Screw for gable moulding fixing slat - Schrauben für befestigungs - leiste - Vis de fixation renforts planches de rives - Viti per distanziatore della stecca di fissaggio - Schroef voor afstand houder lat - Kruvi viilulaua kinnitusele 	50	3.5x50	
HS14 5111	Screw for post - Schrauben für pfosten - Vis de fixation des poteaux - Viti per inviare - Schroef voor stijlen - Kruvi postile 	4	4.5x80	
HS14 5111	Screw for wall details - Schraube für wand details - Vis pour mur details - Viti per elementi della porta - Schroef voor wand details - Kruvi seinte montaažiks 	8	4.5x80	
HS12 5109	Screw for fascia boards - Schrauben für traufbretter - Vis pour fixation bandeau de toit - Viti x striscia del tetto - Schroef voor gevellijst - Kruvi räästalauale 	200	4x40	
HS12 5109	Screw for beam holder - Schrauben für balkenhalter - Vis de fixation support "u" galvanisé - Vite per trave di sostegno - Schroef voor bevestiging balkhouder (gordingschoen) - Kruvi talakingale 	48	4x40	
HS13	Screw for triangular fixing - Montagschraube für dreieckige - Vis d'assemblage pour triangle - Vite per fissaggio triangolare - Schroef voor driehoekig afdekljst - Kruvi kolmnurga monteerimiseks seinale 	10	4x60	
HS18 5113	Screw for roof beams - Schrauben für dachbalken - Vis pour fixation pannes de toit - Viti per perline del tetto - Schroef voor gordingen / dakbalken - Kruvi pärlinitele 	16	5x120	
HS18 5113	Screw for wall details - Schraube für wand details - Vis pour mur details - Viti per elementi della porta - Schroef voor wand details - Kruvi seinadetailidele 	10	5x120	
HS16 5115	Screw for fixing gable moulding distance spacers to the wall - Schrauben für dachstützen - Vis de supports extension toiture - Viti x fissaggio fascioni - Schroef voor bevestiging gevelpunt afstandhouder tot wand - Kruvi viilulaudade distantklõpsi kinnitamiseks seinale 	30	5x90	
HS23 5121	Screw for wall details - Schraube für wand details - Vis pour mur details - Viti per elementi della porta - Schroef voor wand details - Kruvi seinadetailidele 	10	6x180	
HS20 5118	Screw for post height adjustment - Schrauben für regulierungsschraube für pfosten - Vis de fixation de support réglable de poteau - Viti per fissare ed aggiustare l'altezza del palo verticale - Schroef voor hoogte instelling stijlen - Kruvi vajumispolidile 	16	6x50	
HS26 5112	Screw for beam holder - Schrauben für balkenhalter - Vis de fixation support u galvanisé - Vite per trave di sostegno - Schroef voor bevestiging balkhouder (gordingschoen) - Kruvi talakandurile 	64	5x40	
SH44 32512	Hammer block - Schlagholz - Calle de frappe - Blocco di legno da usare come cuscinetto quando si usa il martello - Slagklos - Löögiklots 	1		
SFS 5134	Nut for storm protection - Schraubenmutter für sturmleiste - Erou pour latte anti-tempete - Dado x asta protezione vento - Moer voor stormverankering - Mutter tormikinnusliistule 	12	D8	
NF4 5137	Zn nail for roof - Zn nagel für dachbretter - Pointe pour fixation voliges de toit - Chiodi x perline tetto - Spijker(nagel) voor dakhout - Nael katuselauale 	750	2x50	
NF5 5145	Zn nail for roofing felt fillet - Zn nagel für dachpappenleiste - Pointe pour baguette de fixation feutre bitumeux - Chiodi x carta bituminosa x tetto - Spijker(nagel) voor asfaltpapier afdekljst - Papiliistunael 	50	2x40	
BFS 5159	Bolt for storm protection - Bolzen für sturmleiste - Boulon pour latte anti-tempete - Bullone x asta protezione vento - Bout voor stormankerlat - Puidupolt tormikinnusliistule 	12	8x80	
DFS 5126	Washer for storm protection - Dichtscheibe für sturmleiste - Rondelle pour latte anti-tempete - Rondella x asta protezione vento - Afdichtring voor storm strip - Seib tormikinnusliistule 	12	D8	
BM 37607	Beam holder - Balkenhalter - Support en u galvanisé - Supporto della trave - Balkendrager (gording schoen) - Talaking 	8	45x137	
RP 34582	Post height adjustment - Pfostenträger verstellbar - Support réglable de poteau - Piede registrabile in altezza - Stelschroef voor stijlpost - Vajumispoltt 	2	D20	

Art. Nr. 4432064

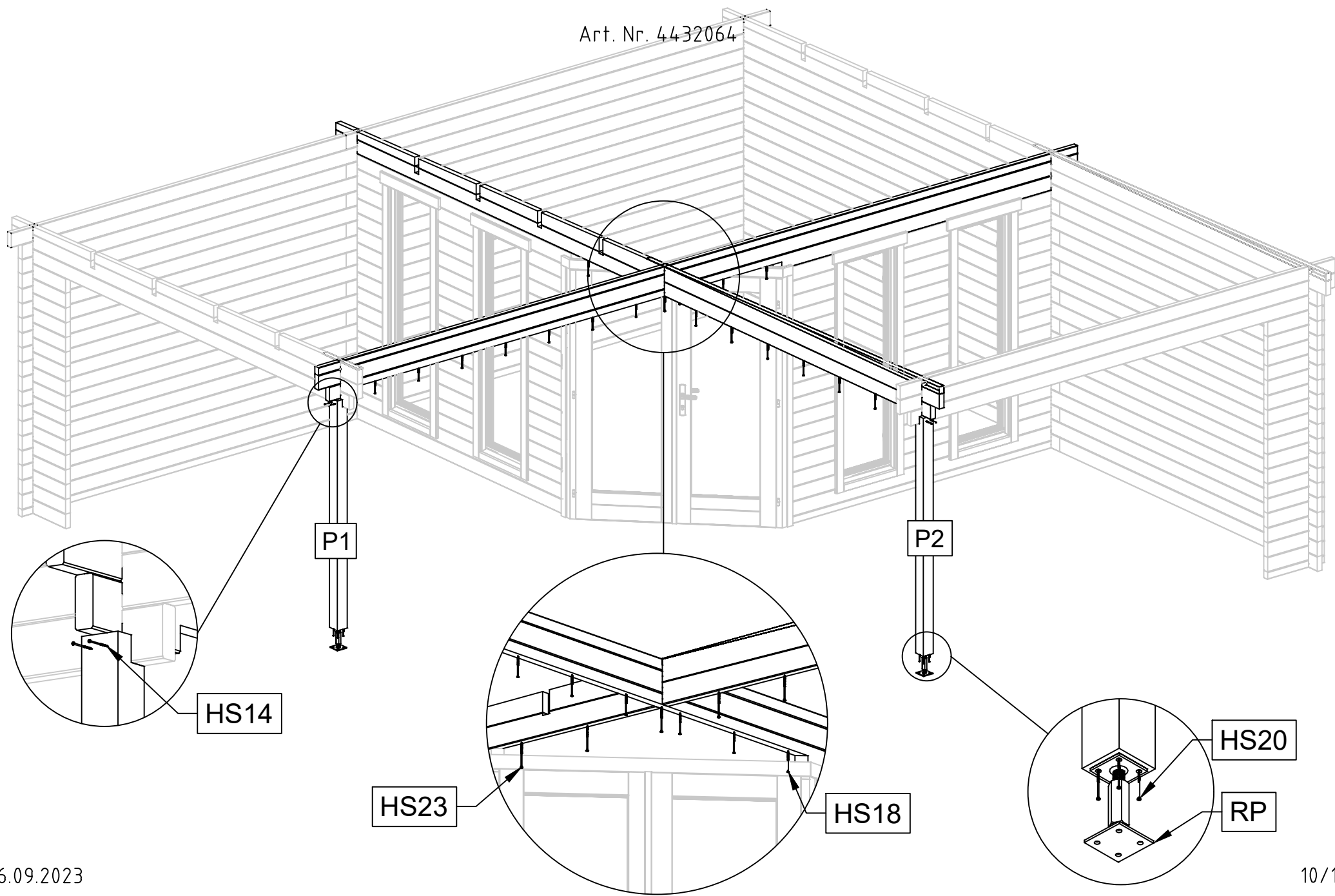

Art. Nr. 4432064

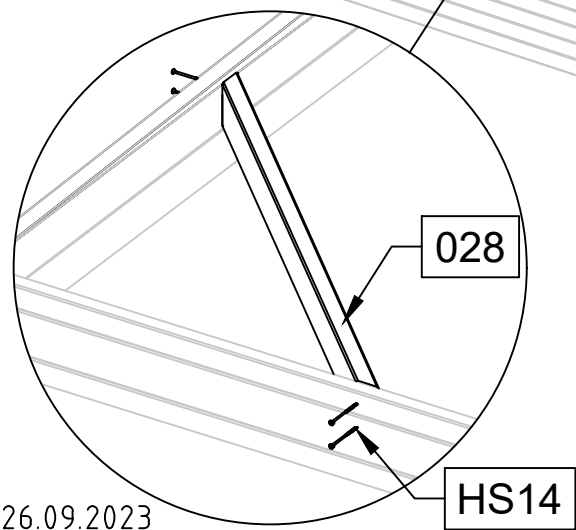

26.09.2023

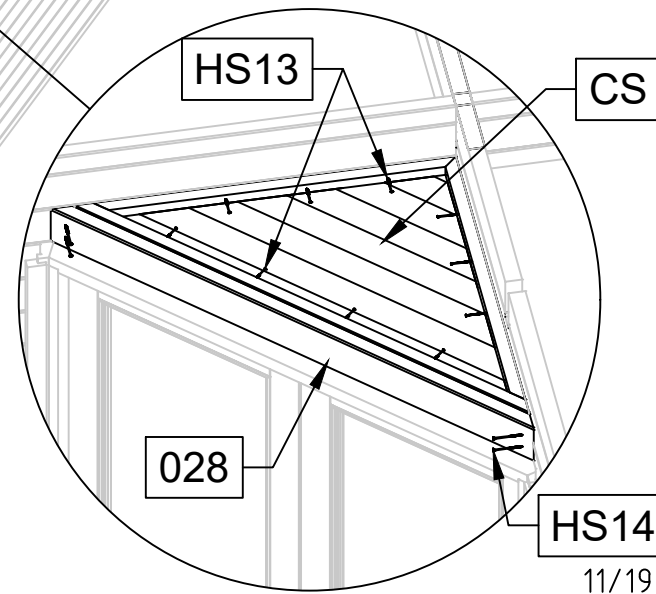

11/19

Art. Nr. 4432064

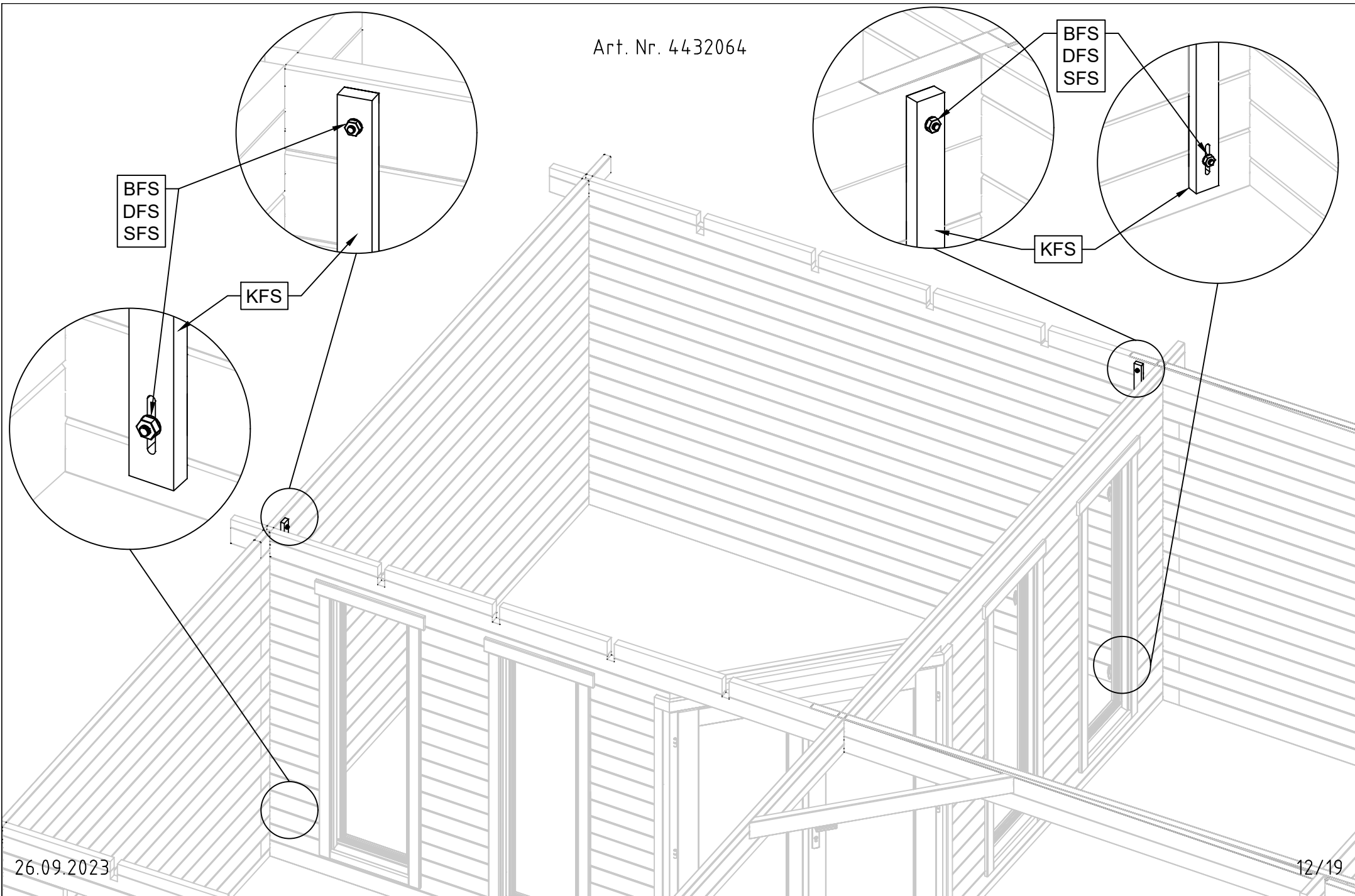

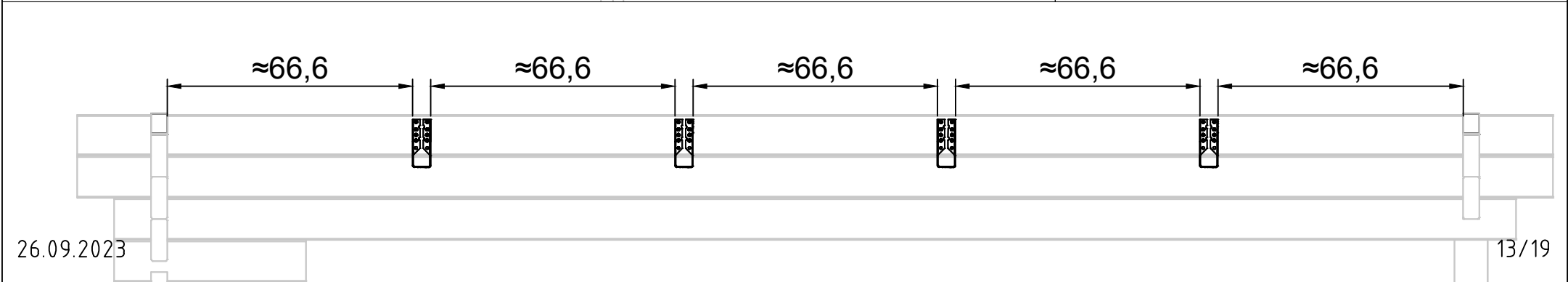
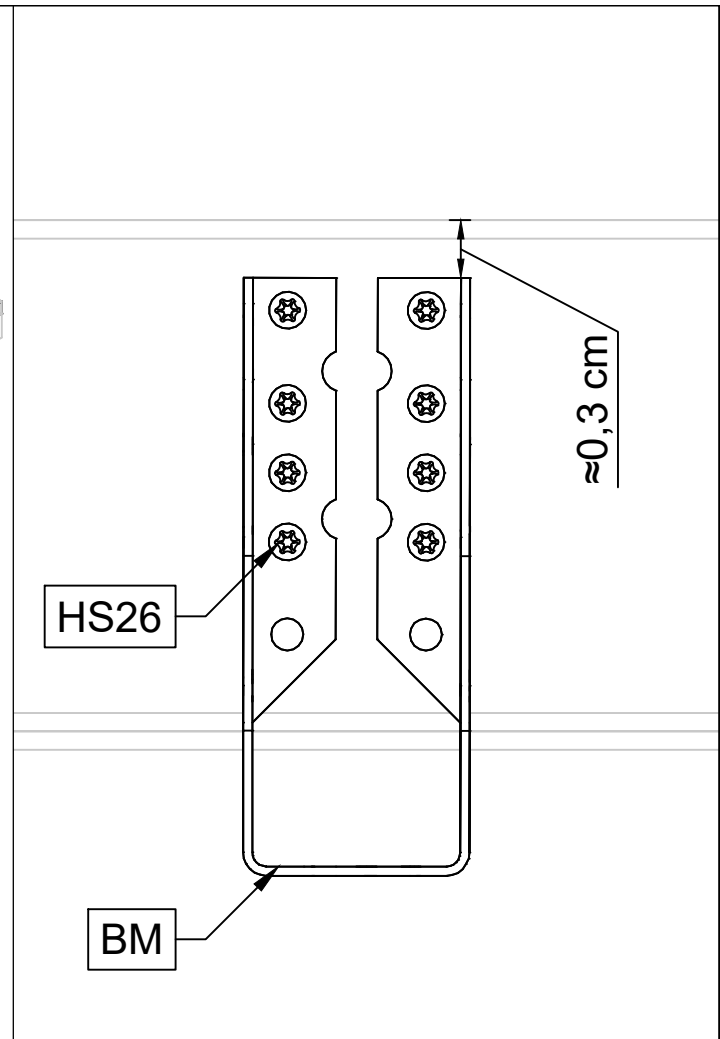
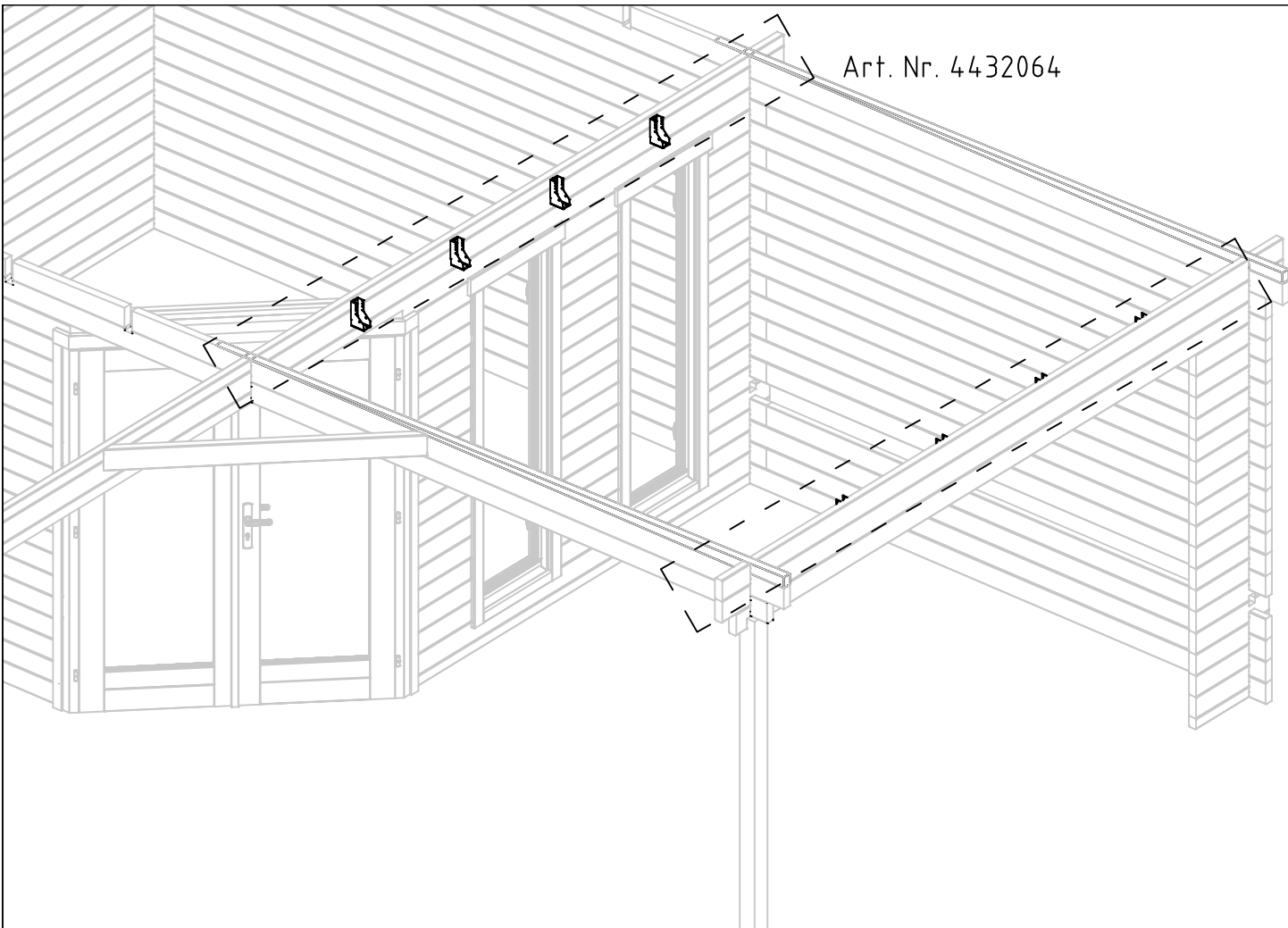

Art. Nr. 4432064

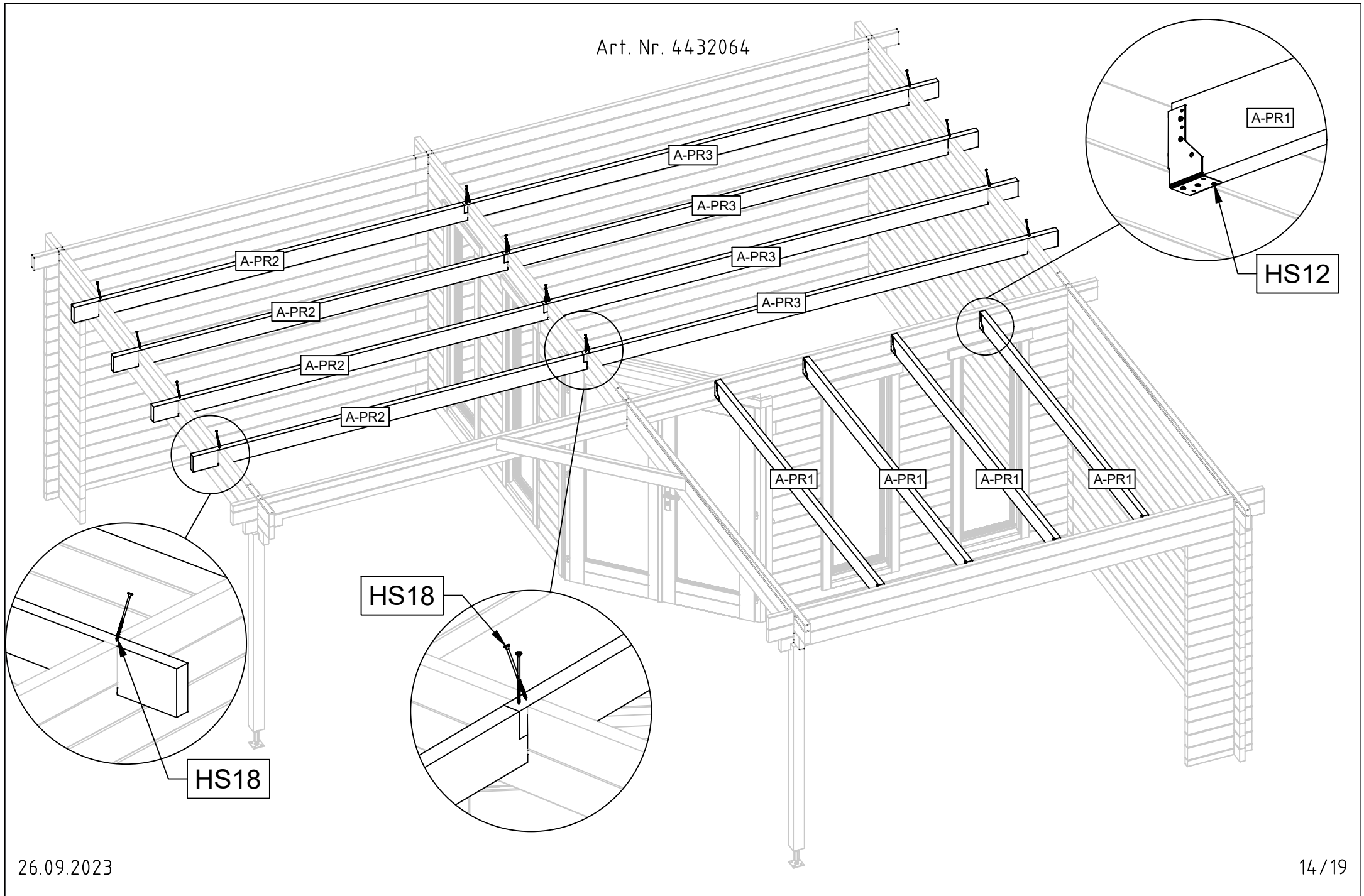

Art. Nr. 4432064

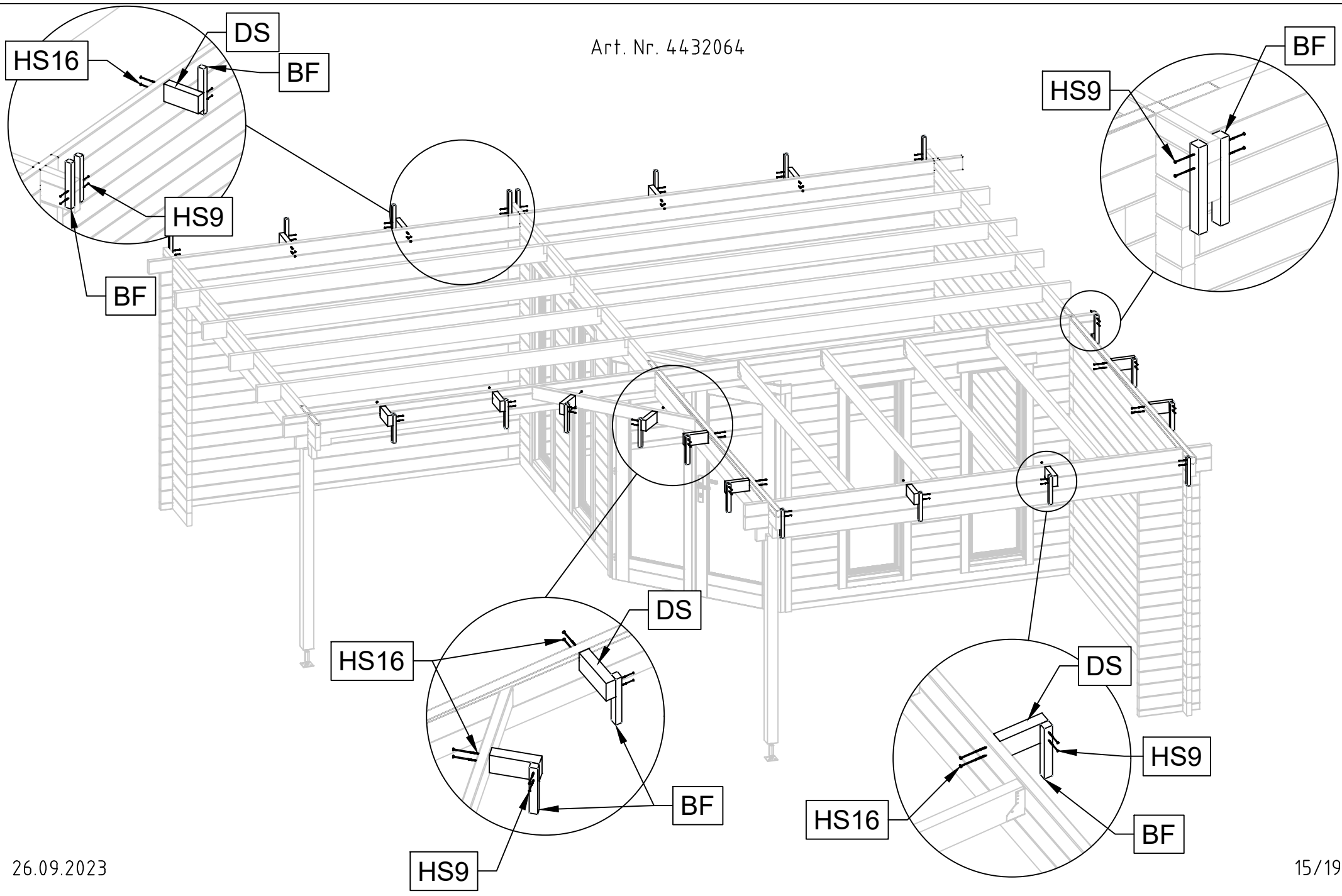

Art. Nr. 4432064

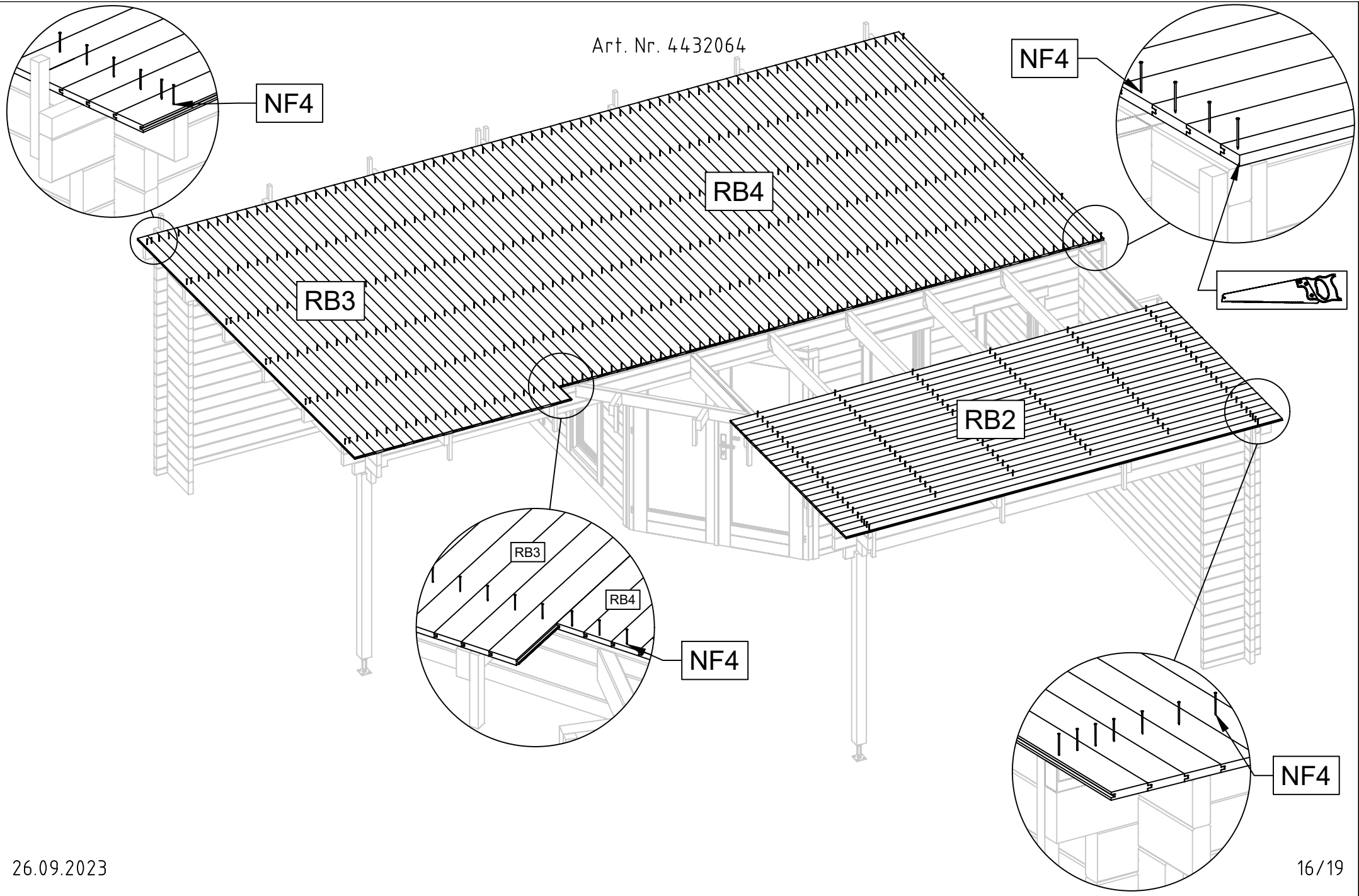

Art. Nr. 4432064

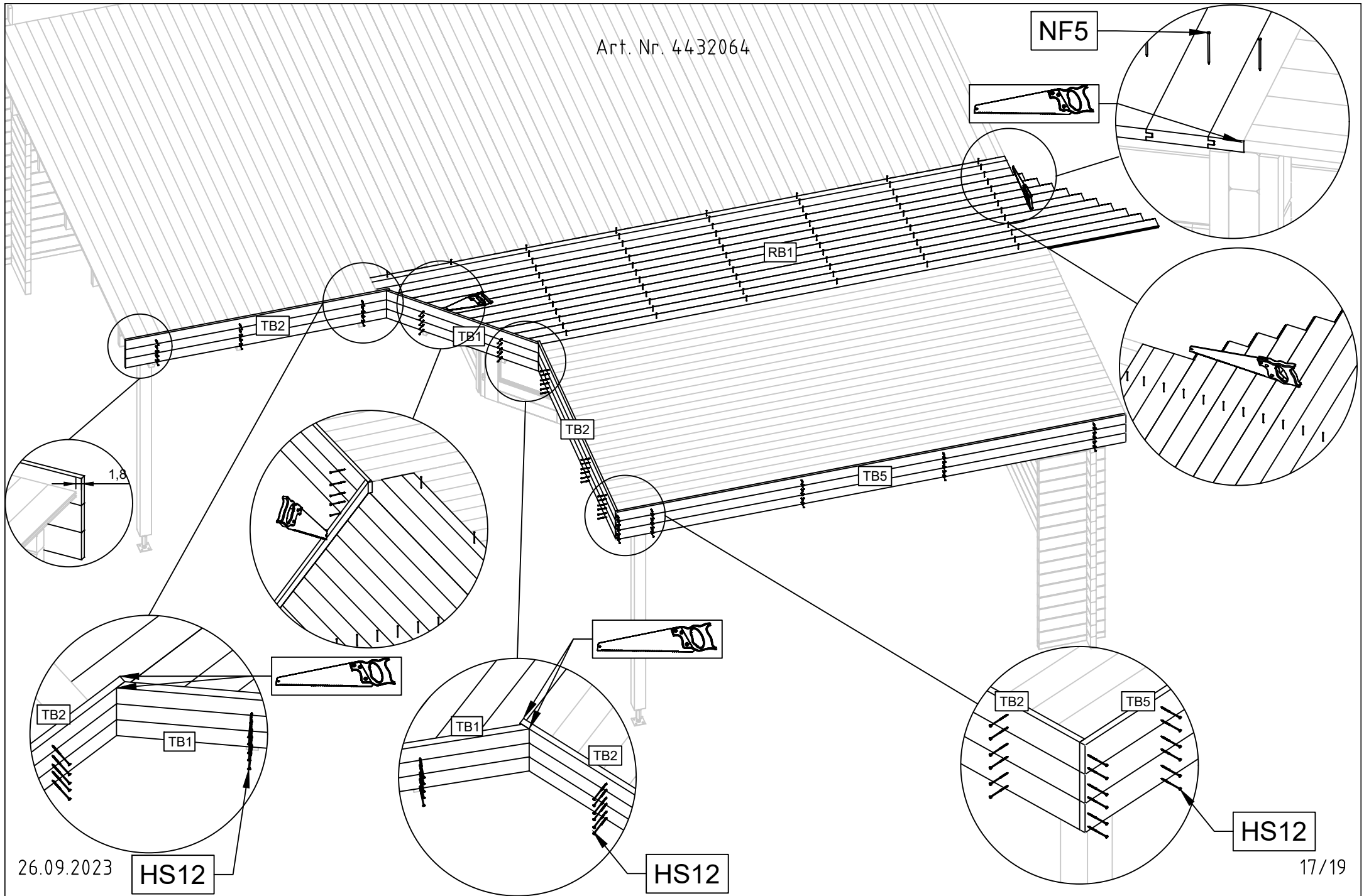

26.09.2023

HS12

HS12

HS12

17/19

Art. Nr. 4432064

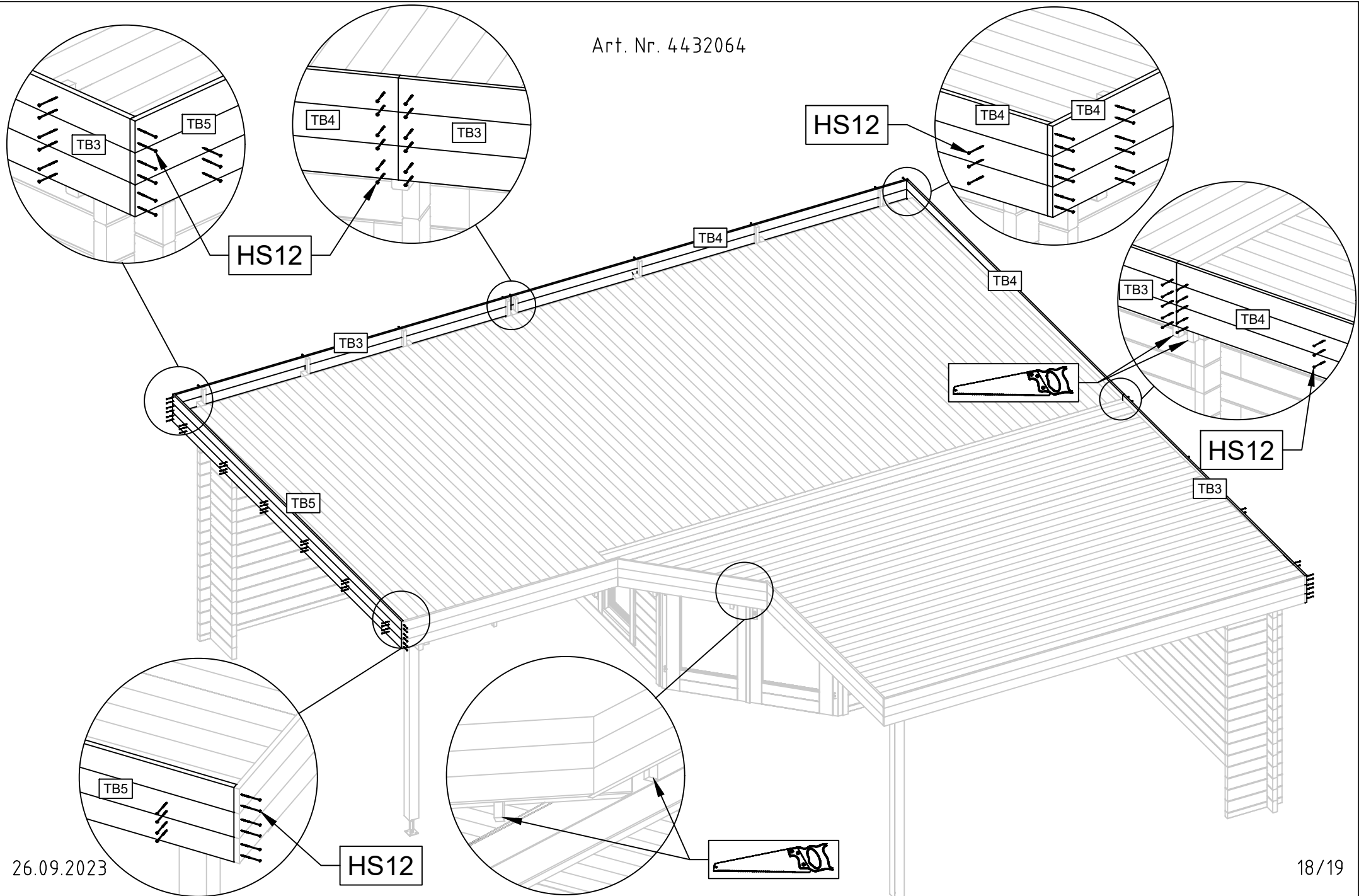

26.09.2023

18/19

Art. Nr. 4432064

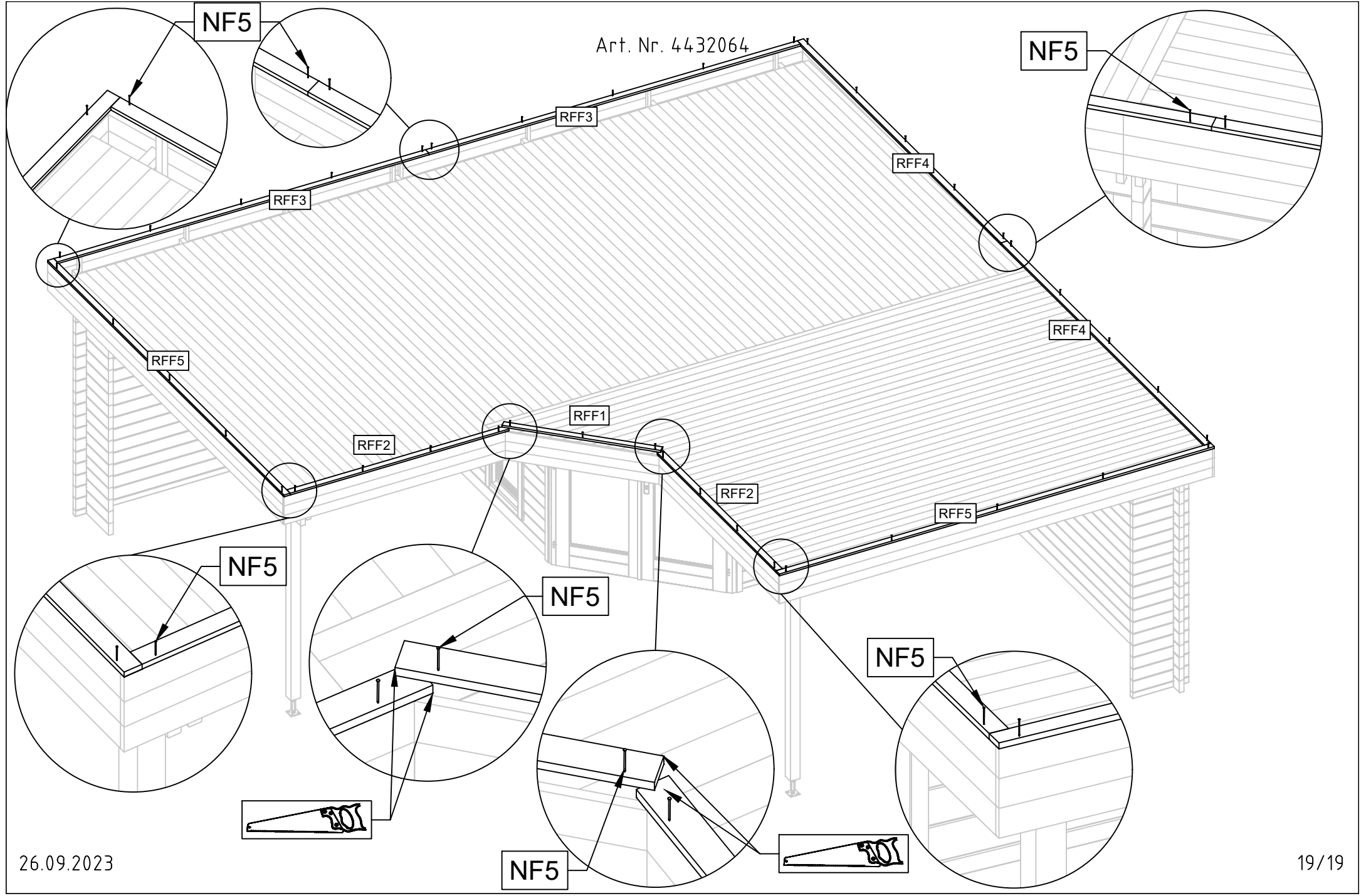

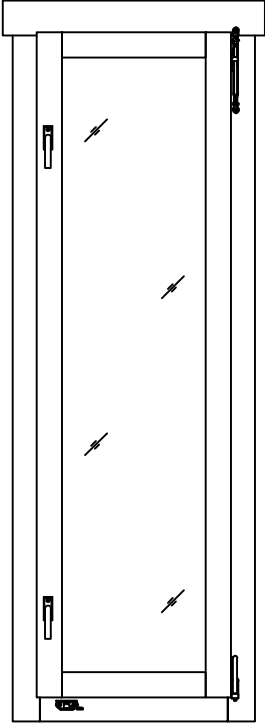
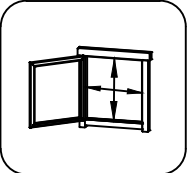
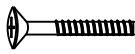
Pos	14.06.2018 Piece list - Stückliste - Liste des pièces - Elementi - Stuklijst - Tükítabel 560x1780 AK.1.100.PSP DGP	1/1	Q	P (mm)	L (mm)
	<p data-bbox="258 152 1292 183">Glass size - Glasgröße - Taille de la vitre - Misura del vetro - Glas afmeting - Klaasi mõõt: 390x1602 mm</p>   <p data-bbox="1364 347 1497 376">460x1684 mm</p>				
FS1	<p data-bbox="258 2042 1021 2101">Window handle fittings - Fenstergriff - Poignee de fenetre - Maniglia c/ferramenta - Raamhendel -/grendel -/klink - Aknalink</p>		2		
FSP	<p data-bbox="258 2123 1101 2199">Bolt for window handle fittings - Bolzen für fenstergriff beschlag - Vis pour fixation poignee de fenetre - Bullone x apertura manuale finestra - Schroef voor raamhendel - Akna käepideme polt</p>		4		

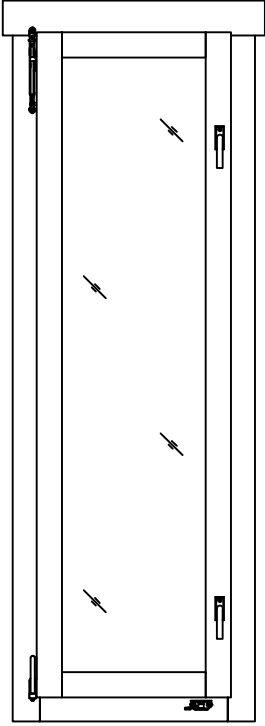
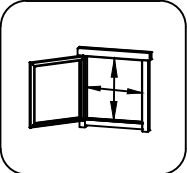
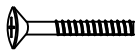
Pos	25.10.2018 Piece list - Stückliste - Liste des pièces - Elementi - Stuklijst - Tükítabel 560x1780 AK.1.100.PSV DGP	1/1	Q	P (mm)	L (mm)
	<p data-bbox="258 152 1292 183">Glass size - Glasgröße - Taille de la vitre - Misura del vetro - Glas afmeting - Klaasi mõõt: 390x1602 mm</p>   <p data-bbox="1364 347 1497 376">460x1684 mm</p>				
FS1	<p data-bbox="258 2042 1021 2101">Window handle fittings - Fenstergriff - Poignee de fenetre - Maniglia c/ferramenta - Raamhendel -/grendel -/klink - Aknalink</p>		2		
FSP	<p data-bbox="258 2123 1101 2199">Bolt for window handle fittings - Bolzen für fenstergriff beschlag - Vis pour fixation poignee de fenetre - Bullone x apertura manuale finestra - Schroef voor raamhendel - Akna käepideme polt</p>		4		

Pos	14.09.2023	Piece list - Stückliste - Liste des pièces - Elementi - Stuklijst - Tükitalabel 14.94x1957 TUK.1.100.PVP.MM5b DGP	1/2	Q	P (mm)	L (mm)
-----	------------	--	-----	---	-----------	-----------

Glass size - Glasgröße - Taille de la vitre - Misura del vetro - Glas afmeting - Klaasi mõõt: 524x1618 mm

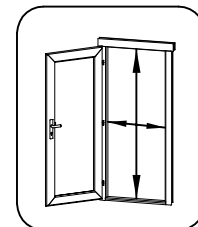
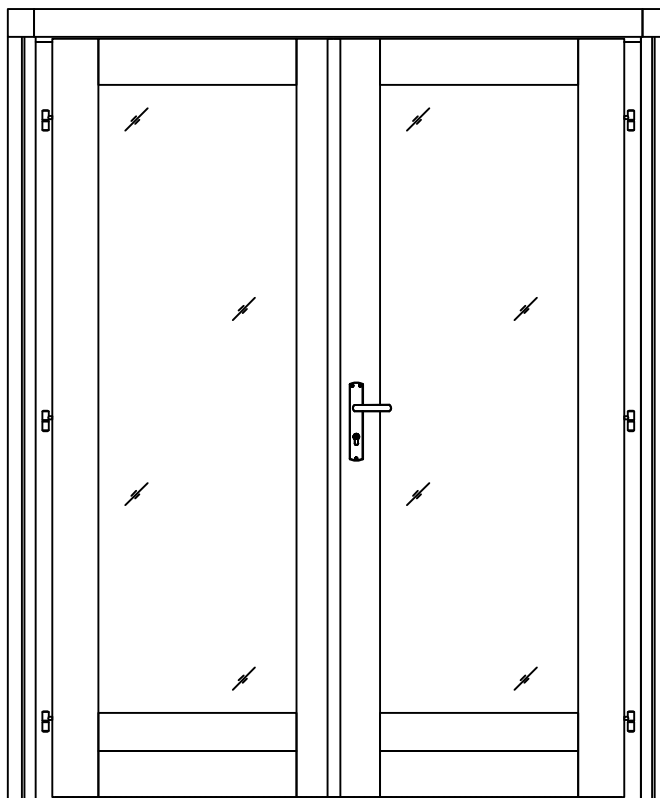

1418x1900 mm

1	Left door jamb - Türrahmen links - Cadre de porte gauche - Telaio montante sinistro della porta - Linkerstijl deurframe - Ukse vasak leng		1	99x102	1957
1	Right door jamb - Türrahmen rechts - Cadre de porte droit - Telaio montante destro della porta - Rechterstijl deurframe - Ukse parem leng		1	99x102	1957
2	Upper door jamb - Türrahmen oben - Cadre de porte supérieur - Telaio superiore della porta - Bovendorpel - Ukse ülemine leng		1	38x80	1538
3	Covering moulding - Deckungsprofil - Profils de finition verticaux a fixer a l'exterieur du cadre de la porte - Cornice di finitura - Afdek profiel - Lengi piirdelaud		4	28x50	1942
4	Covering moulding - Deckungsprofil - Profils de finition verticaux a fixer a l'exterieur du cadre de la porte - Cornice di finitura - Afdek profiel - Lengi piirdelaud		2	28x70	94
5	Covering moulding - Deckungsprofil - Profils de finition verticaux a fixer a l'exterieur du cadre de la porte - Cornice di finitura - Afdek profiel - Lengi piirdelaud		2	28x70	64
6	Covering moulding - Deckungsprofil - Profils de finition verticaux a fixer a l'exterieur du cadre de la porte - Cornice di finitura - Afdek profiel - Lengi piirdelaud		1	28x70	1487
7	Covering moulding - Deckungsprofil - Profils de finition verticaux a fixer a l'exterieur du cadre de la porte - Cornice di finitura - Afdek profiel - Lengi piirdelaud		1	28x70	1546
8	Connection strip - Deckleiste - Baguette de battement - Profilo verticale della porta - Stulplijst - Kokkuvaltsiliist		1	13x30	1927
9	Doorstep - Swelle - Barre de seuil - Soglia della porta - Deurdorpel - Lävepak		1	18x80	1438

