

*Kensington*  
*Art. Nr. 4414340*  
*1/10*



GROUNDPLAN - GRUNDPLAN - PLAN DE MASSE

2

1

A

B

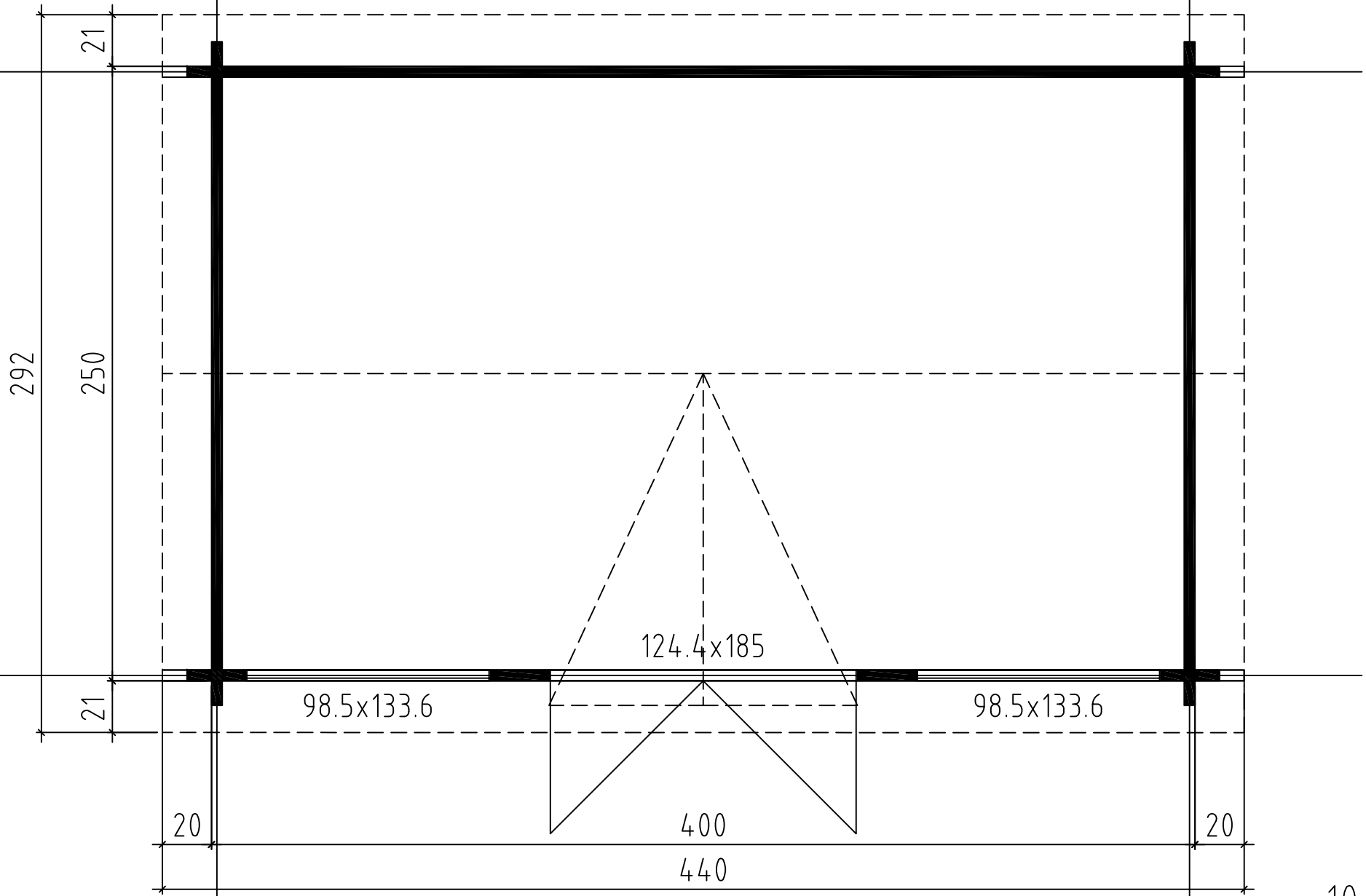

FOUNDATION - FUNDAMENT - FONDATION

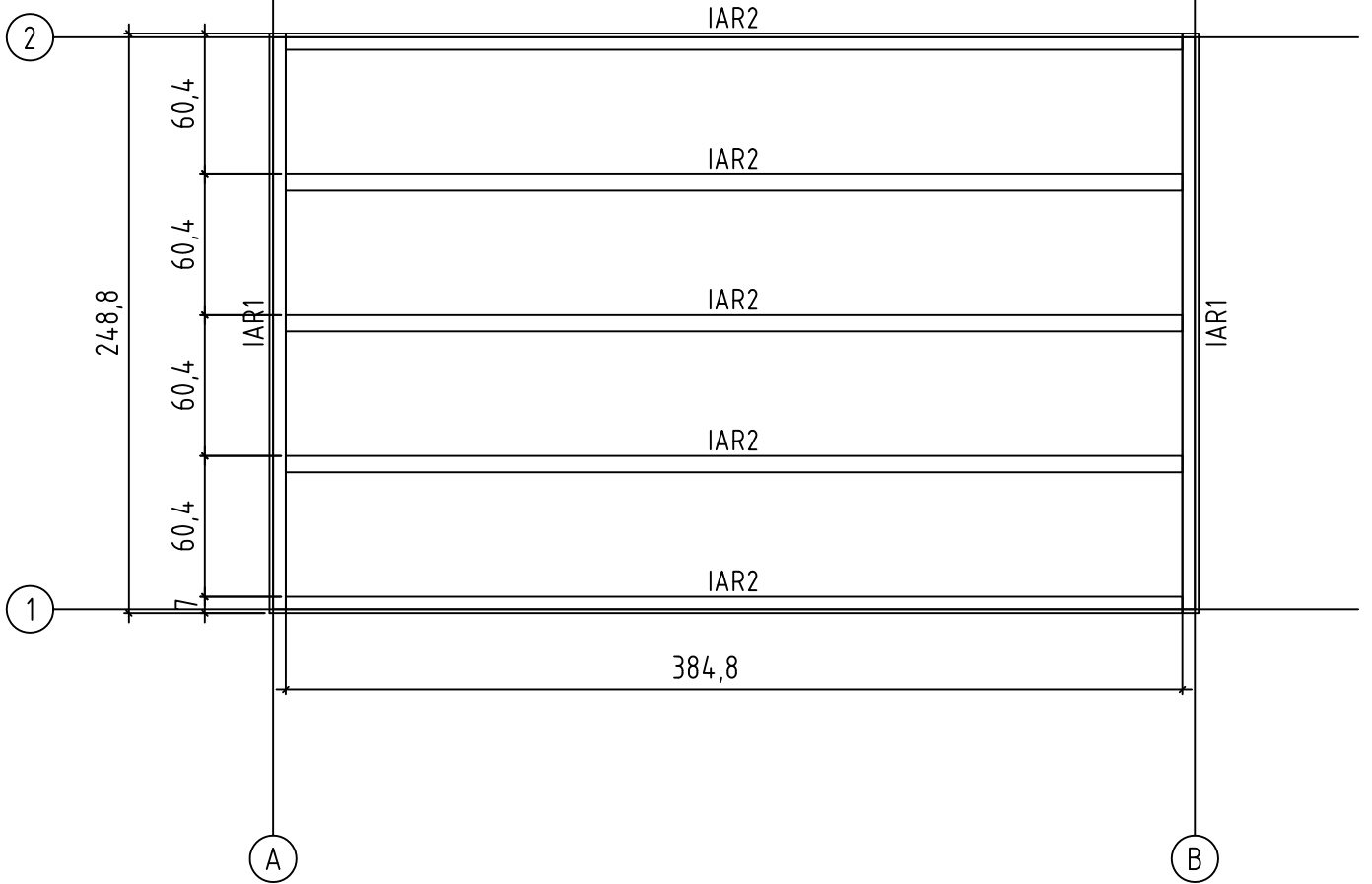

FLOOR BOARDS - FUSSBODENBRETTER - LAME DE PLANCHER

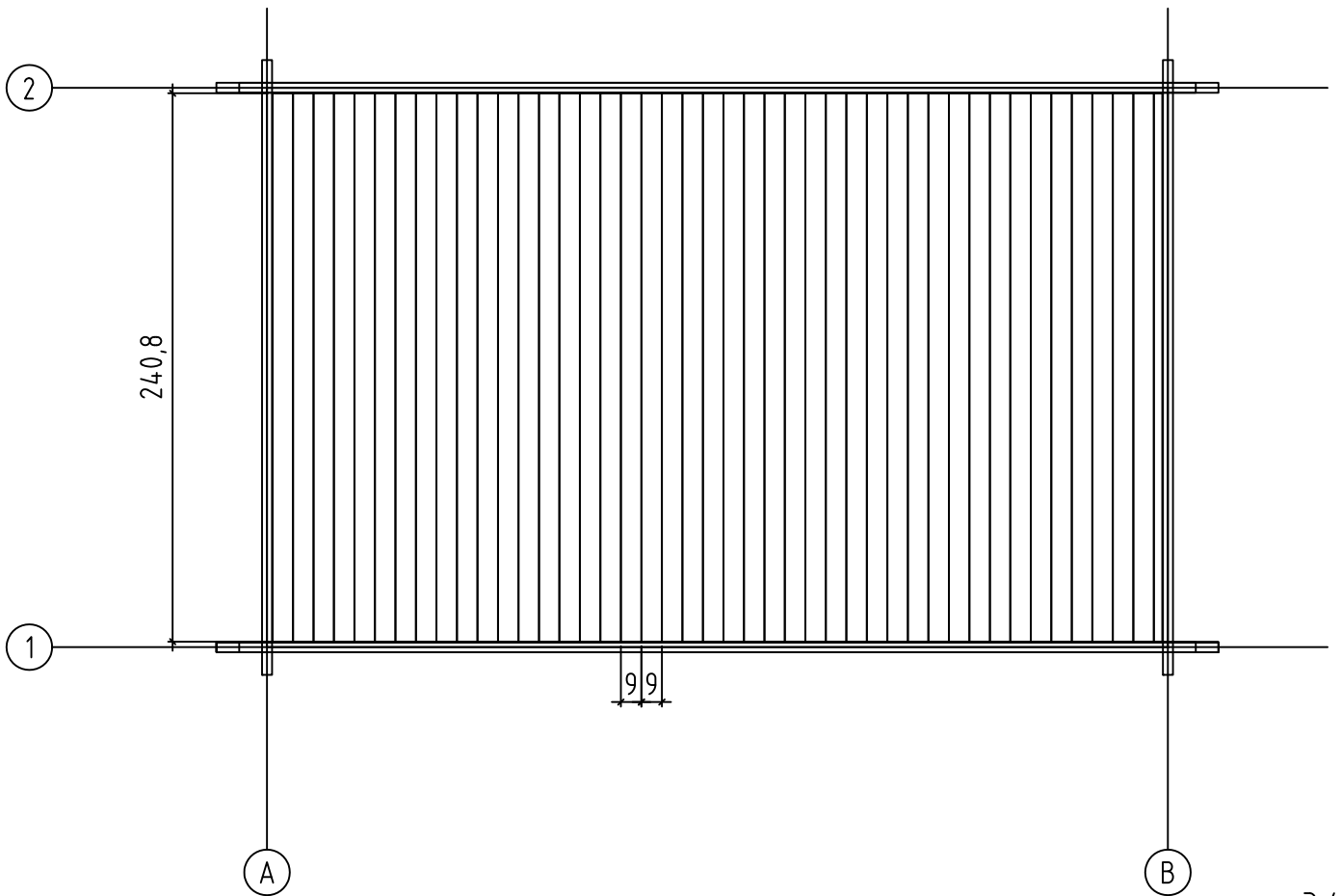



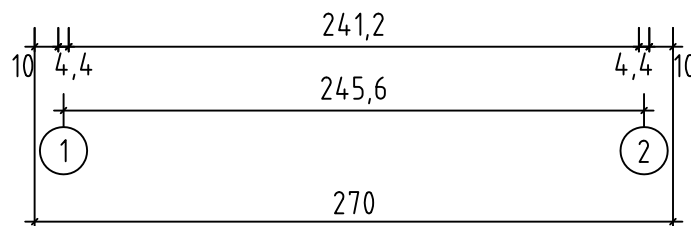
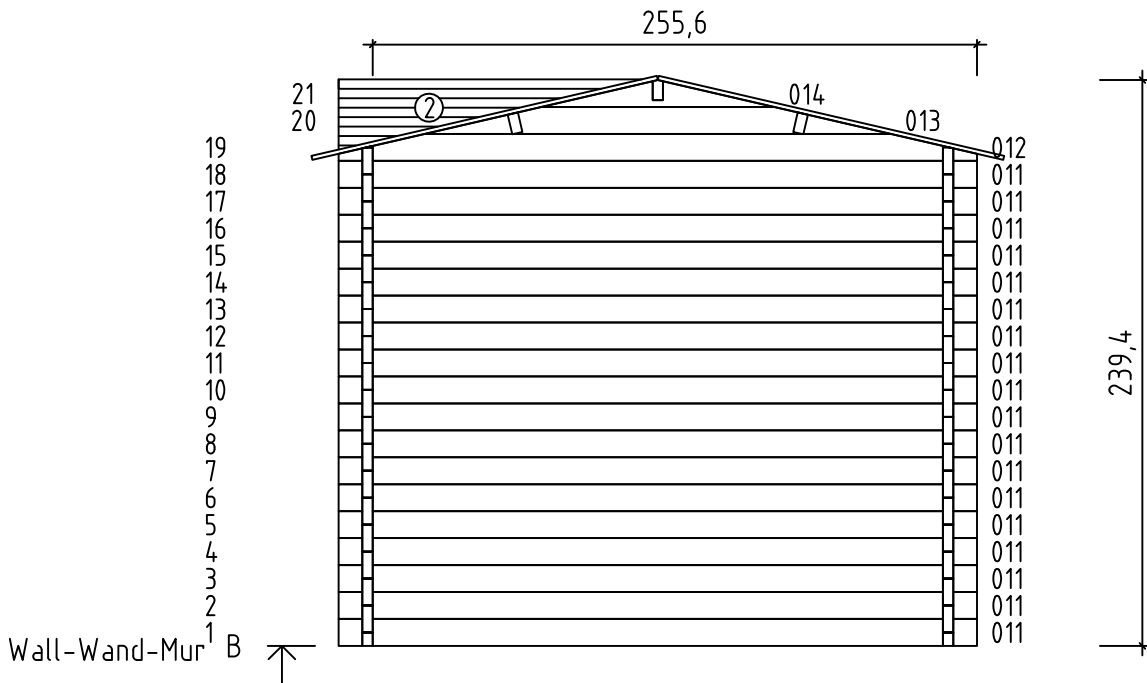
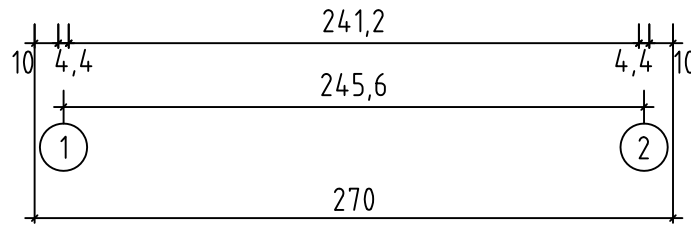
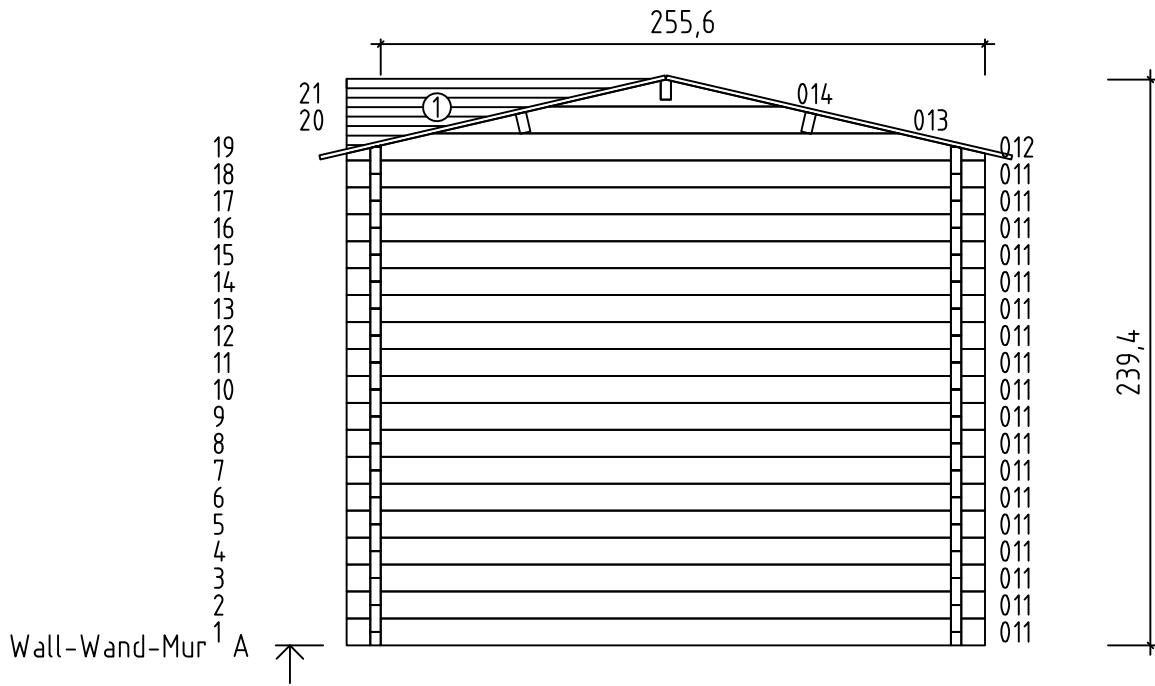



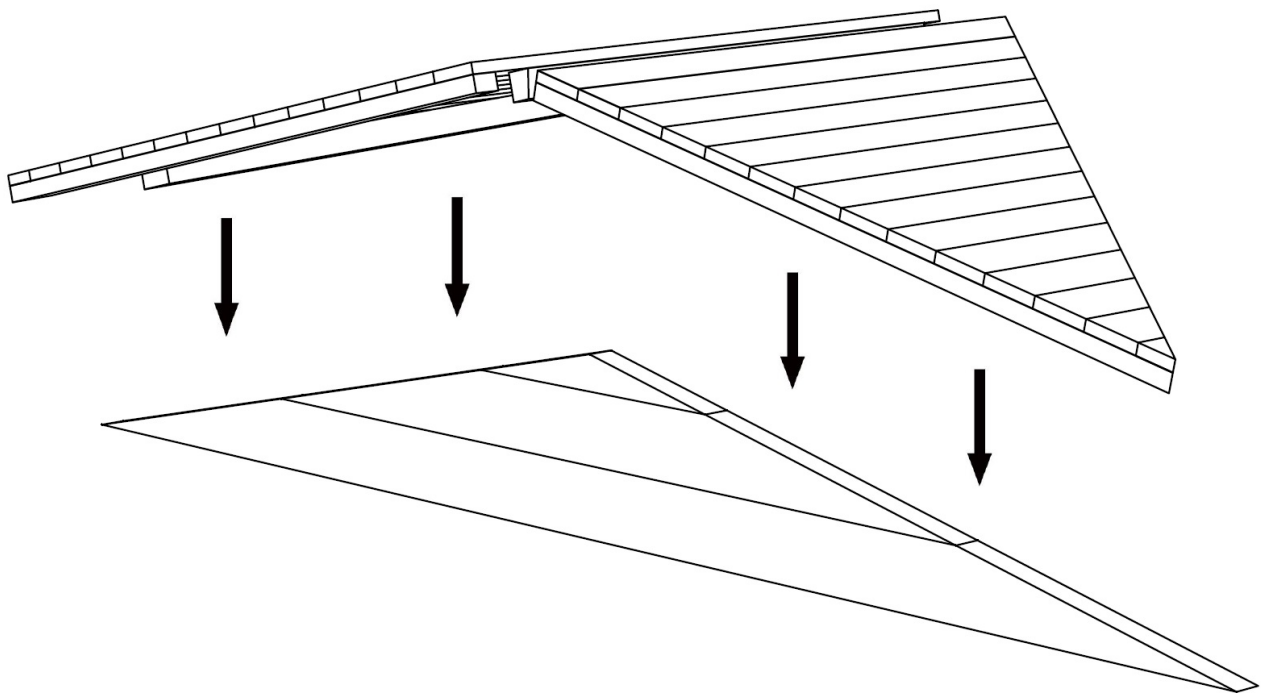
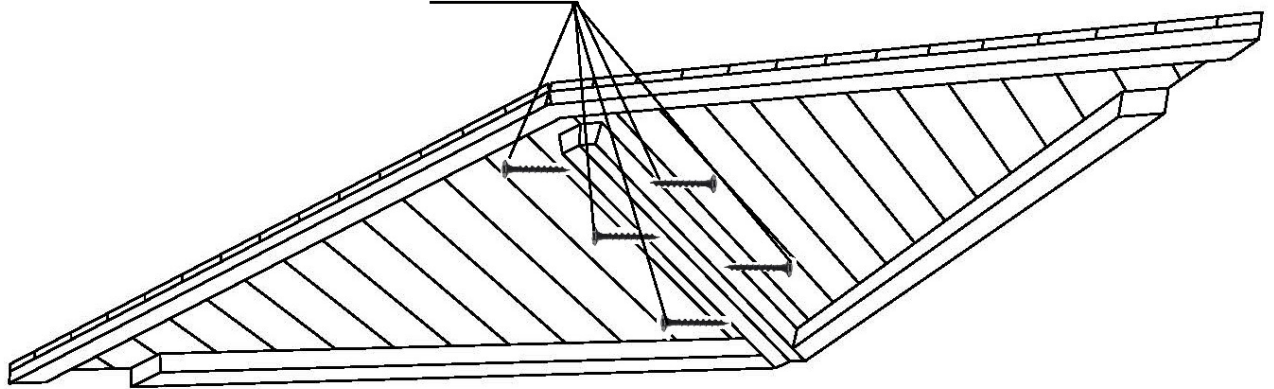

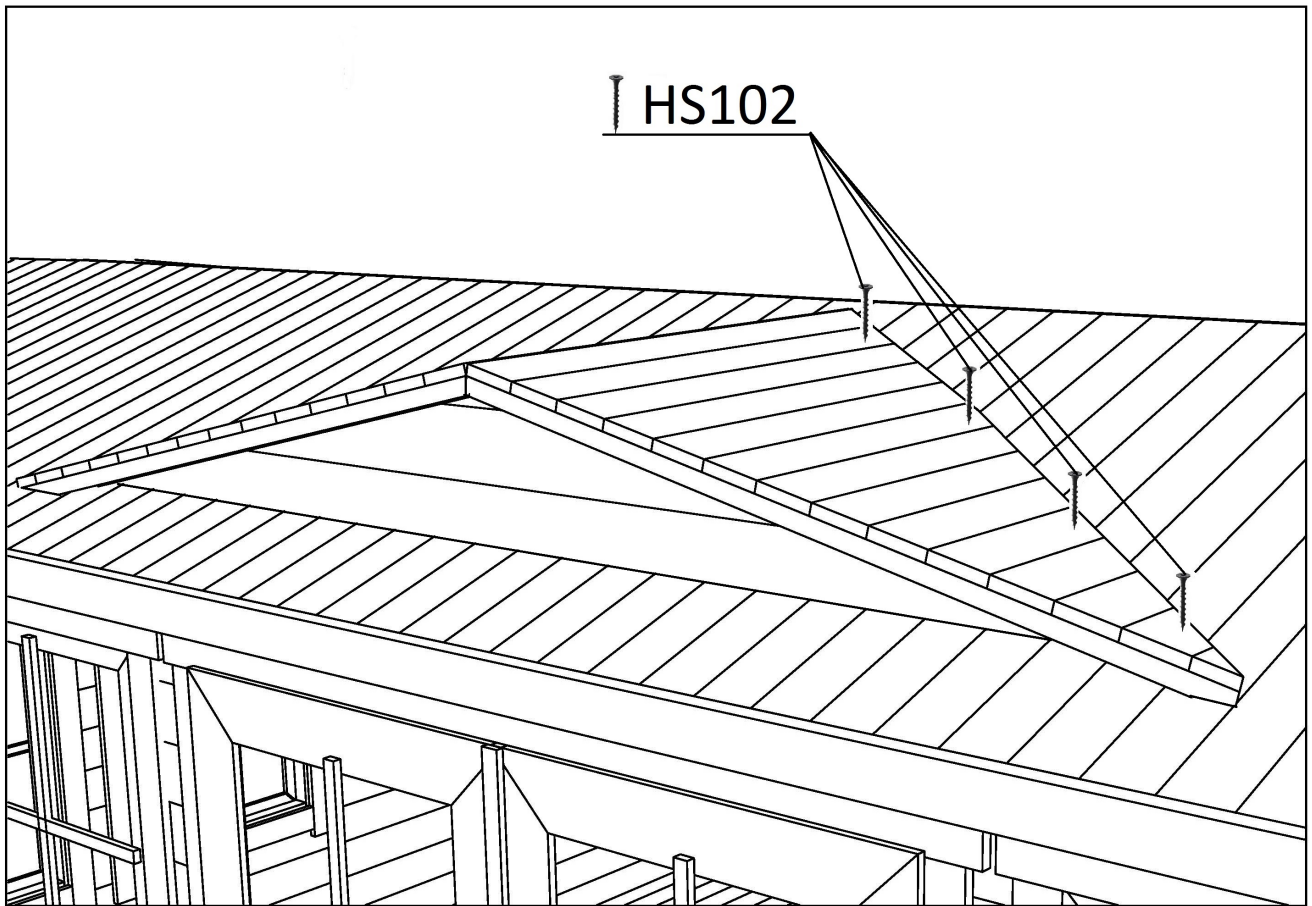
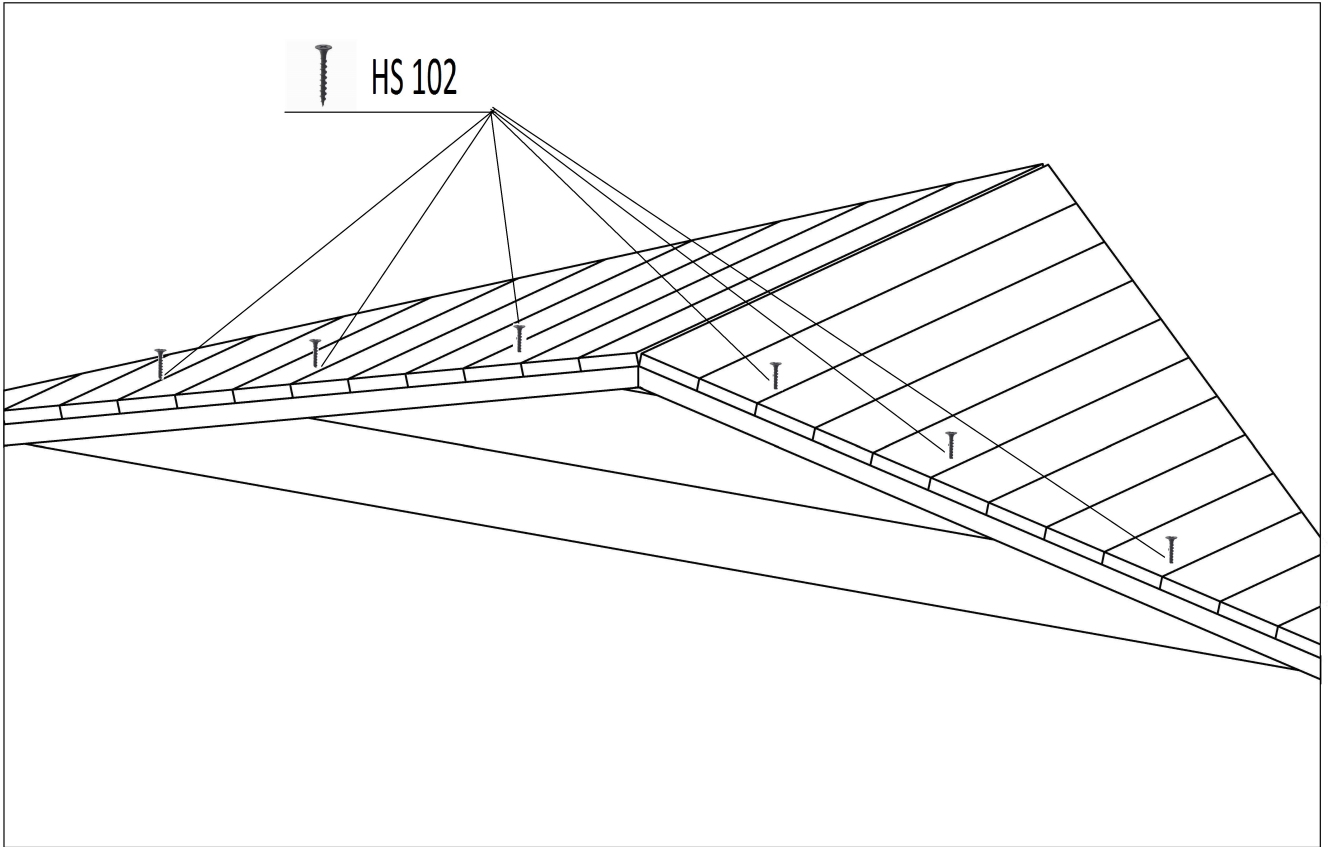

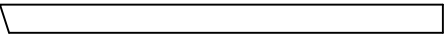
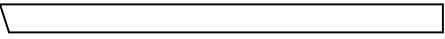
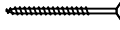





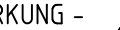

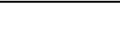
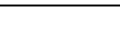
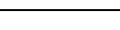
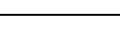
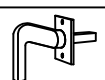

HS 102

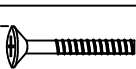

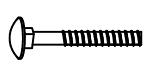

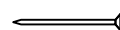

Pos	9/10	Piece list - Stückliste - Liste des pièces Art.Nr. 4414340	10.09.2013	Q.	P (mm)	L (mm)
GL	GABLE MOULDING - GIEBELLEISTE - PLANCHE DE RIVE			4	18x120	1550
GL1	GABLE MOULDING - GIEBELLEISTE - PLANCHE DE RIVE			2	18x90	720
HS88	VIS DE BARRES GEORGIANNE SCREW FOR GEORGIAN BARS - SCHRAUBE FÜR SPROSSEN -			24	2.5x20	
HS89	SCREW FOR GEORGIAN BARS - SCHRAUBE FÜR SPROSSEN - VIS DE BARRES GEORGIANNE			12	2.5x20	
HS12	SCREW FOR GABLE SEGMENT - SCHRAUBEN FÜR DECKBLATT - VIS POUR FIXATION LOSANGE DE FINITION			6	3.5x50	
HS16	SCREW FOR GABLE MOULDING - SCHRAUBEN FÜR GIEBELLEISTE - VIS DE FIXATION POUR PLANCHE DE RIVE			24	3.5x50	
HS3	SCREW FOR DOOR FILLET - SCHRAUBE ZUR BEFESTIGUNG TÜRLEISTE - VIS D'ASSEMBLAGE DU CADRE DE PORTE			5	3x30	
HS32	SCREW FOR EAVES BOARDS - SCHRAUBEN FÜR TRAUFBRETT - VIS DE FIXATION POUR BANDEAU DE TOIT			20	4x40	
HS26	SCREW FOR ROOF EDGE REINFORCEMENT - SCHRAUBEN FÜR DACHRANDVERSTÄRKUNG - VIS POUR RENFORT DE BORD DE TOIT			20	4x40	
HS102	SCREW FOR ROOF SHIELD - SCHRAUBEN FÜR ELEMENT - VIS DE FIXATION DE PANNEAU DE TOITURE			27	4x60	
HS43	SCREW FOR ROOF BEAMS - SCHRAUBEN FÜR DACHBALKEN - VIS POUR PANNE DE TOIT			8	5x120	
HS40	SCREW FOR 1. WALL BEAM - SCHRAUBE FÜR 1. BOHLENREIHE - VIS DE FIXATION DES FONDATIONS			8	5x90	
HS39	SCREW FOR FUNDAMENT - SCHRAUBEN ZUR BEFESTIGUNG FUNDAMENT - VIS POUR FONDATION			10	5x90	
HS41	SCREW FOR DOOR JAMB - SCHRAUBE FÜR TÜRRAHMEN - VIS DE FIXATION POUR MONTANT DE PORTE			4	5x90	
FS3	WINDOW HANDLE FITTINGS-FENSTERGRIFF - POIGNÉE D'OUVERTURE DE FENETRE			4		
NFF	ZN NAIL FOR FLOOR FILLET - ZN NÄGEL FÜR FUSSBODENLEISTE - POINTE POUR CORNIERE DE FINITION DU PLANCHER			26	1.4x40	
SH44	HAMMER BLOCK - SCHLAGHOLZ - CALLE DE FRAPPE			1		
MS	SCREW FOR DOORSTEP - SCHRAUBEN FÜR TÜRSCHWELLE - VIS DE FIXATION DU SEUIL DE PORTE			3	4.5x65	
NFD	ZN NAIL FOR ROOFING FELT FILLET - ZN NÄGEL FÜR DACHPAPPENLEISTE - POINTE POUR BAGUETTE FIXATION FEUTRE BITUMEUX			22	2x40	
TS	BOLT FOR WINDOW HANDLE FITTINGS - BOLZEN FÜR FENSTERGRIFF BESCHLAG - BOULON POUR POIGNÉE D'OUVERTURE DE FENETRE			8		
GS	GABLE SEGMENT-DECKBLATT - LOSANGE DE FINITION			3		
SFS	NUT FOR STORM PROTECTION - SCHRAUBENMUTTER FÜR STURMLEISTE - ÉCROU POUR LAME ANTI-TEMPETE			8		
BFS	BOLT FOR STORM PROTECTION - BOLZEN FÜR STURMLEISTE - VIS POUR LAME ANTI-TEMPETE			8		
DFS	WASHER FOR STORM PROTECTION - DICHTSCHEIBE FÜR STURMLEISTE - RONDELLE POUR LAME ANTI-TEMPETE			8		
NF2	ZN NAIL FOR ROOF - ZN NÄGEL FÜR DACHBRETT - POINTE POUR TOIT			306	2x50	

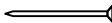
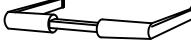

Pos	8/10	Piece list - Stückliste - Liste des pièces Art.Nr. 4414340	10.09.2013	Q.	P (mm)	L (mm)
001				2	44x57	1473
002				8	44x114	1473
003				24	44x114	244
004				24	44x114	234
005				18	44x114	4200
006				2	44x120	4400
010				1	44x57	4200
011				36	44x114	2700
W1-1				1		
WA-1				1		
WB-1				1		
IAR2		FOUNDATION - FUNDAMENT - FONDATION		5	70x45	3848
IAR1		FOUNDATION - FUNDAMENT - FONDATION		2	70x45	2488
PR11		ROOF BEAM - DACHBALKEN - PANNE DE TOIT		1	44x140	4400
A.PR21		ROOF BEAM - DACHBALKEN - PANNE DE TOIT		2	44x140	4400
FB	FLOOR BOARDS - FUSSBODENBRETTER - LAME DE PLANCHER			44	90x18	2408
DB	ROOF BOARDS - DACHBRETTER - VOLIGES			98	90x18	1500
FL	FLOOR FILLET-FUSSBODENLEISTE - CORNIERE DE FINITION DU PLANCHER				18x18	12.63
DPL	ROOFING FELT FILLET - DACHPAPPENLEISTE - BAGUETTE DE FIXATION DU FEUTRE BITUMEUX			4	18x58	1550
DPL	ROOFING FELT FILLET - DACHPAPPENLEISTE - BAGUETTE DE FIXATION DU FEUTRE BITUMEUX			2	18x58	720
TB	EAVES BOARD - TRAUFBRETT - BANDEAU DE TOIT			2	18x90	4400
DRV	ROOF EDGE REINFORCEMENT - DACHRANDVERSTÄRKUNG - CORNIERE DE RENFORT DE BORD DE TOIT			2	28x34	4400
KFS	STORM PROTECTION - STURMLEISTE - LATTE ANTI-TEMPETE			4	22x45	2000

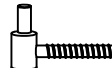
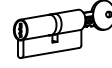
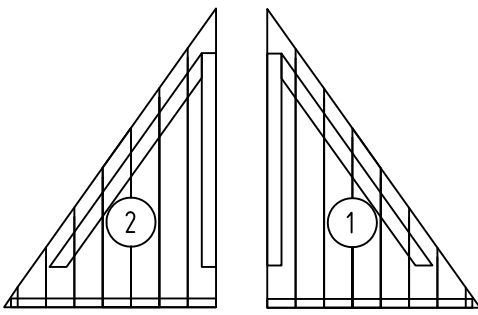
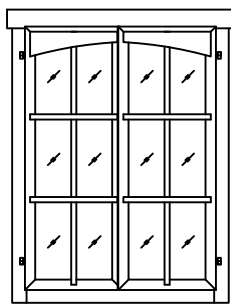
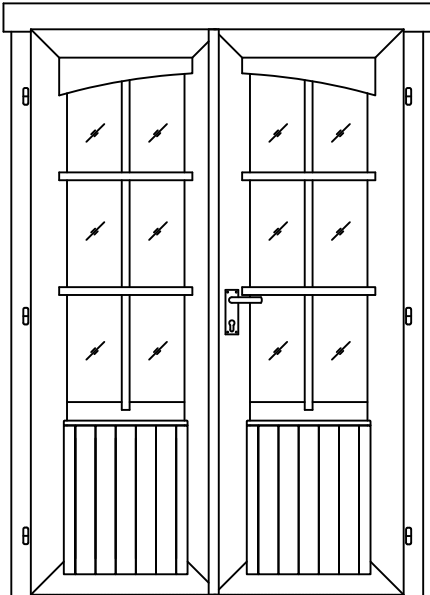
Pos	10/10	Piece list - Stückliste - Liste des pièces Art.Nr. 4414340	10.09.2013	Q.	P (mm)	L (mm)
NH1	ZN NAIL FOR FLOOR - ZN NÄGEL FÜR FUSSBODENBRETTER - CLOUS POUR PLANCHER		225	2x50		
TS3	DOOR HANDLE FITTINGS-TÜRGRIF - SET DE GARNITURES DE SERRURE DE PORTE		1			
TS4	SET OF DOOR LOCK COVERS - SCHLOSSBLENDEN - SET DE GARNITURES DE SERRURE DE PORTE		1			
TS2	MALE BOLT HINGE FOR DOOR - TÜRRIEGEL - PARTIE MALE DE CHARNIERE DE PORTE		6			
TS6	CYLINDER LOCK -ZYLINDERSCHLOSS - CYLINDRE DE SERRURE		1			
	ROOF SHIELD - ELEMENT - PANNEAU DE TOITURE		2			
	WINDOW 985x1336 TAK.1.106.PVP.Kf		2			
	DOOR 1244x1850 TUK.2.066.PVP.MMKWe		1			