

TAHITI 70
ART.NR. 701302
1/12

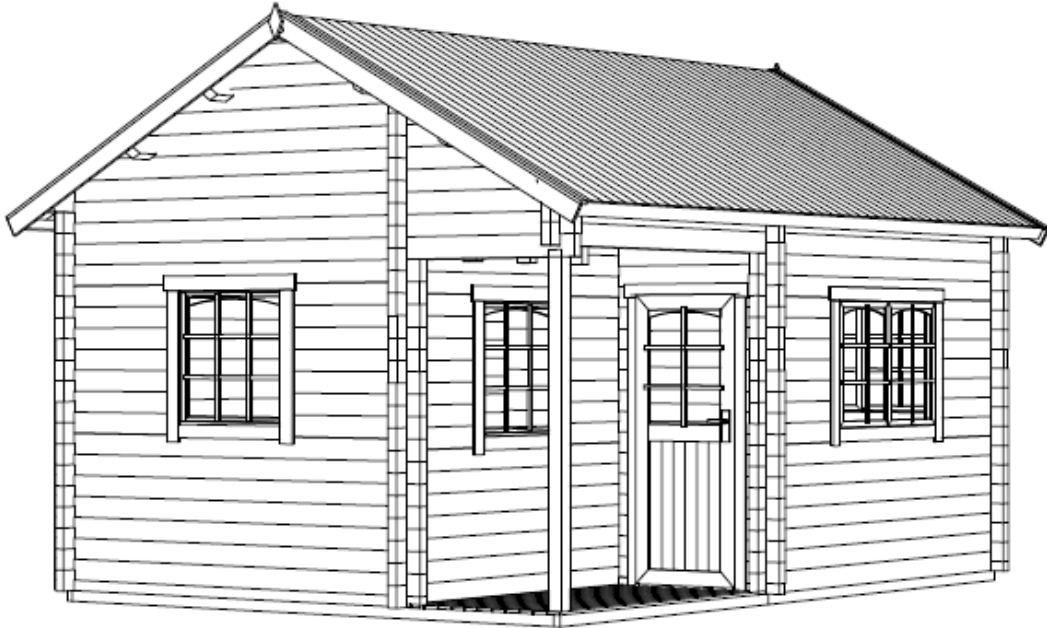

GROUNDPLAN - GRUNDPLAN - PLAN DE MASSE

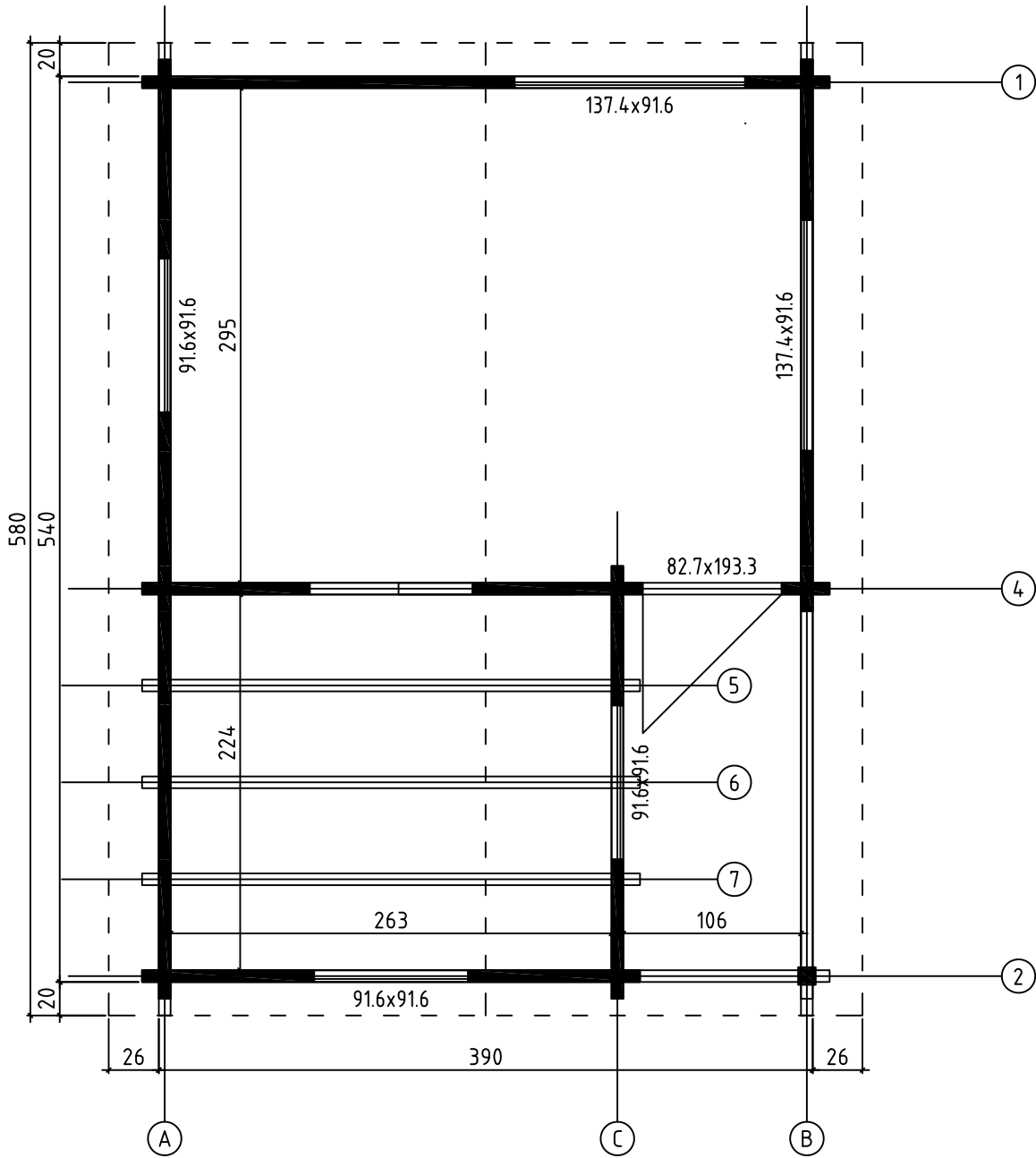

FOUNDATION - FUNDAMENT - FONDATION

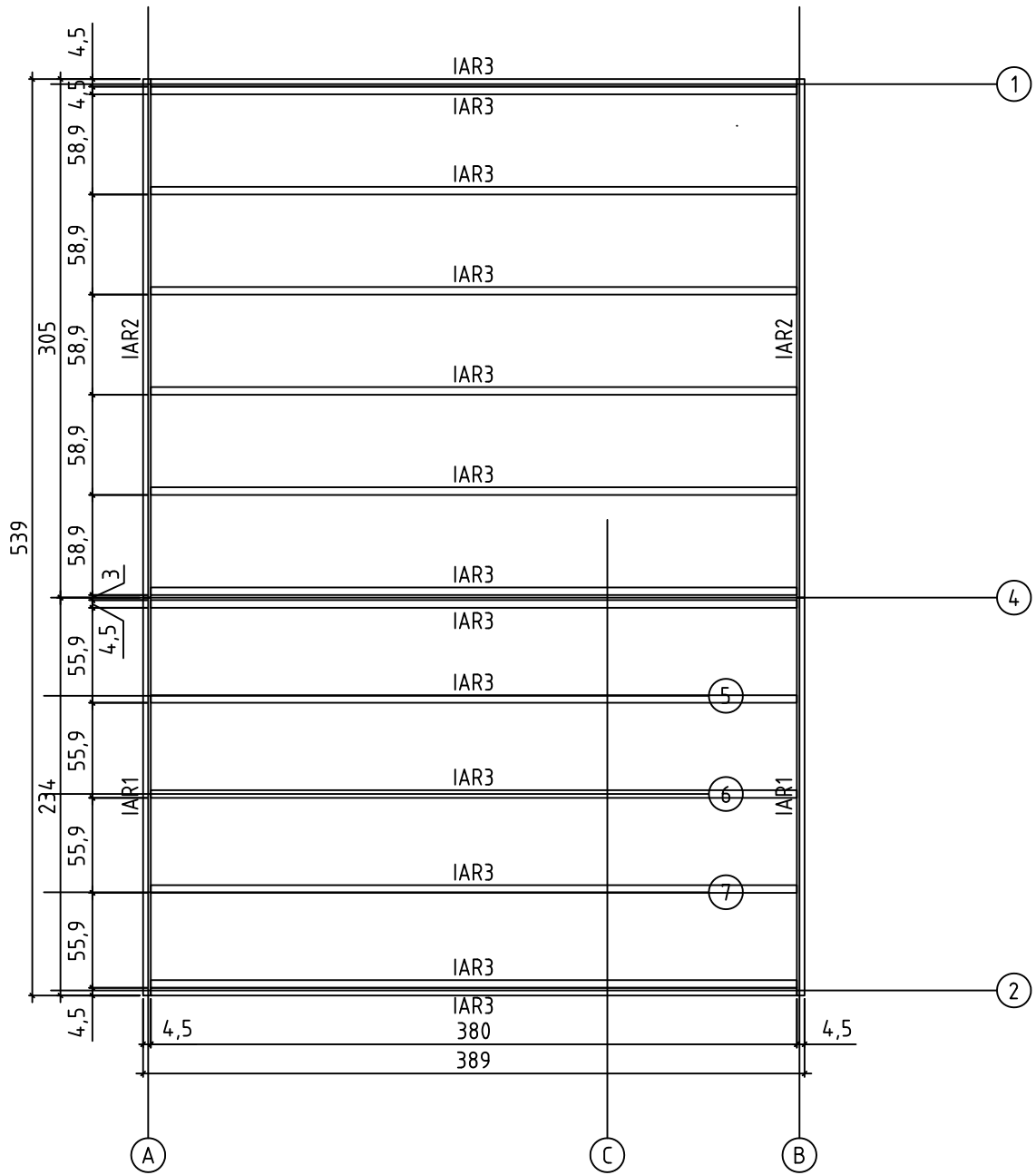

FLOOR BOARDS - FUSSBODENBRETTER - PLAN POSE PLANCHER

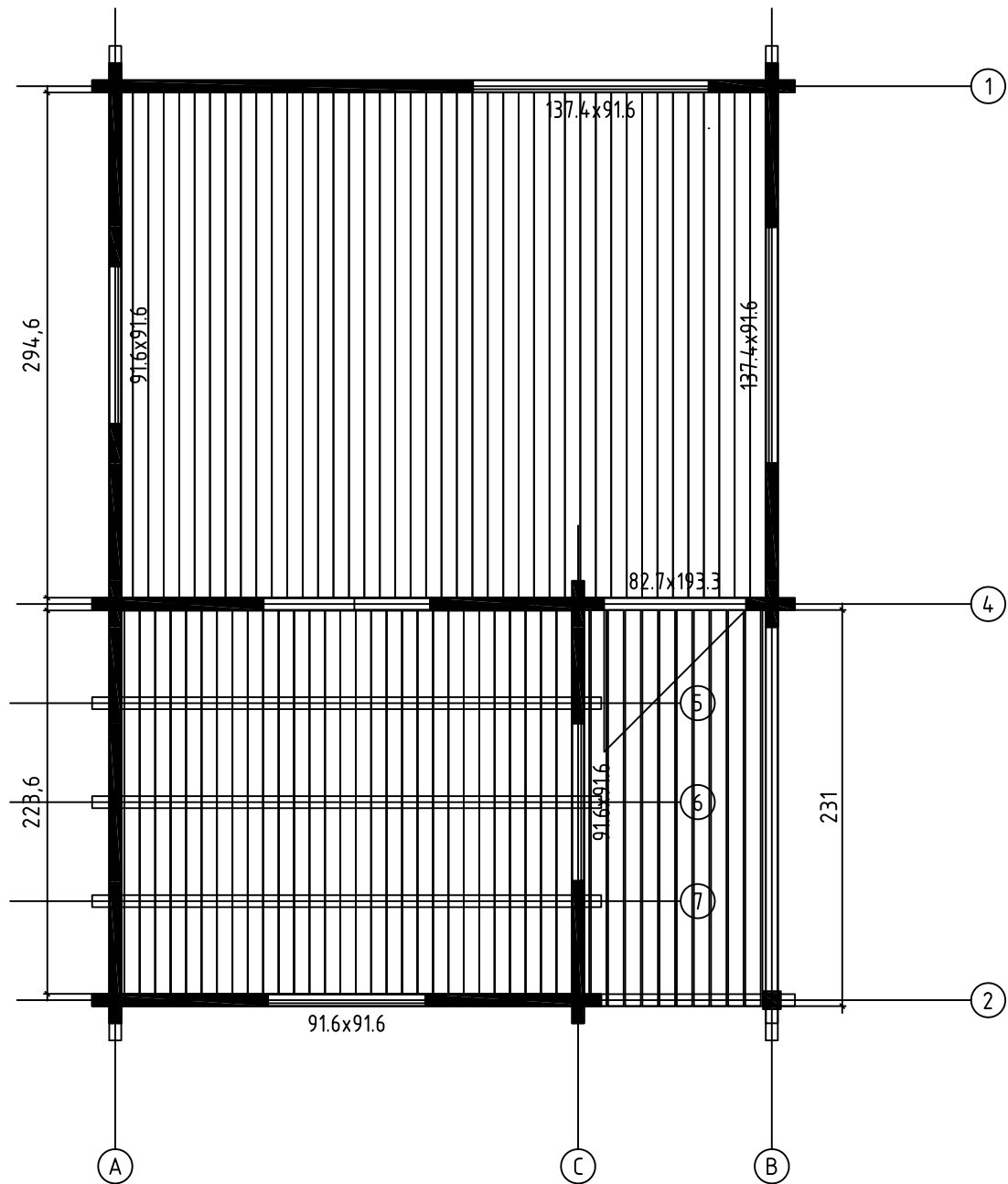

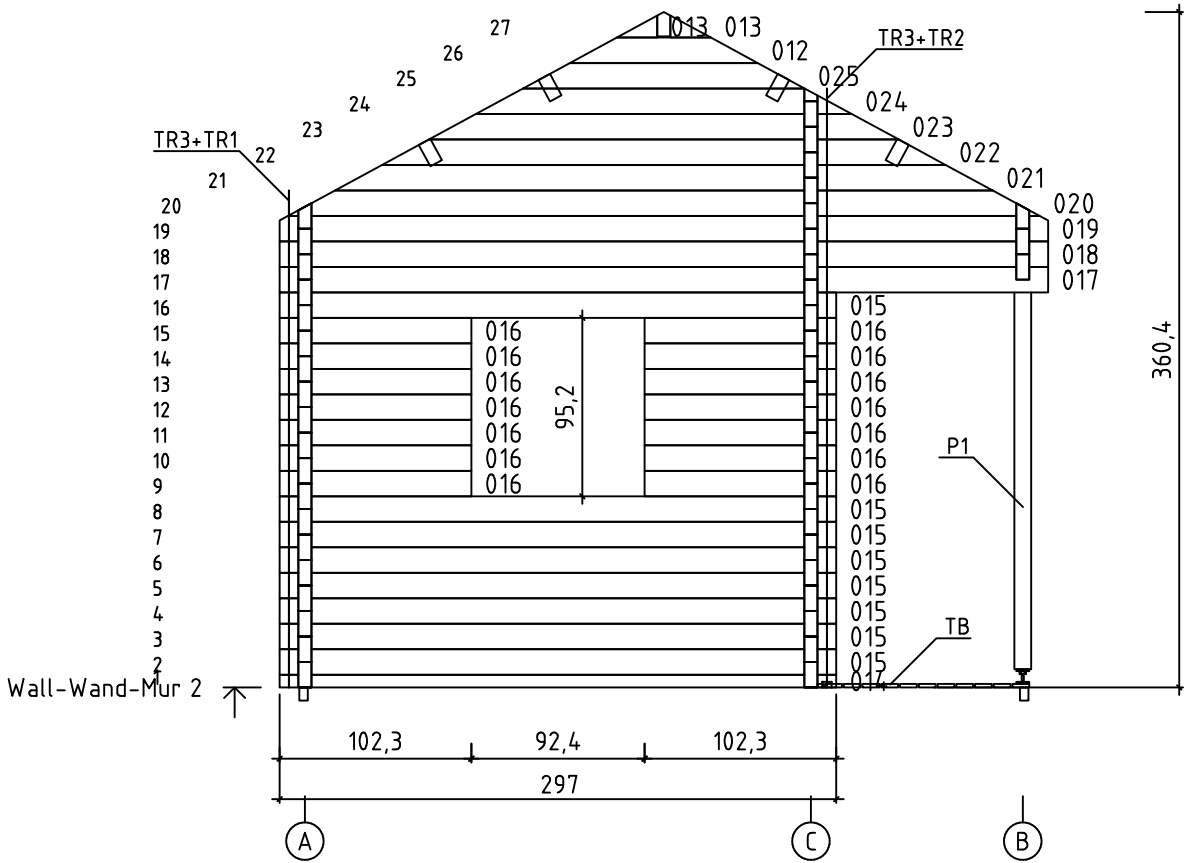
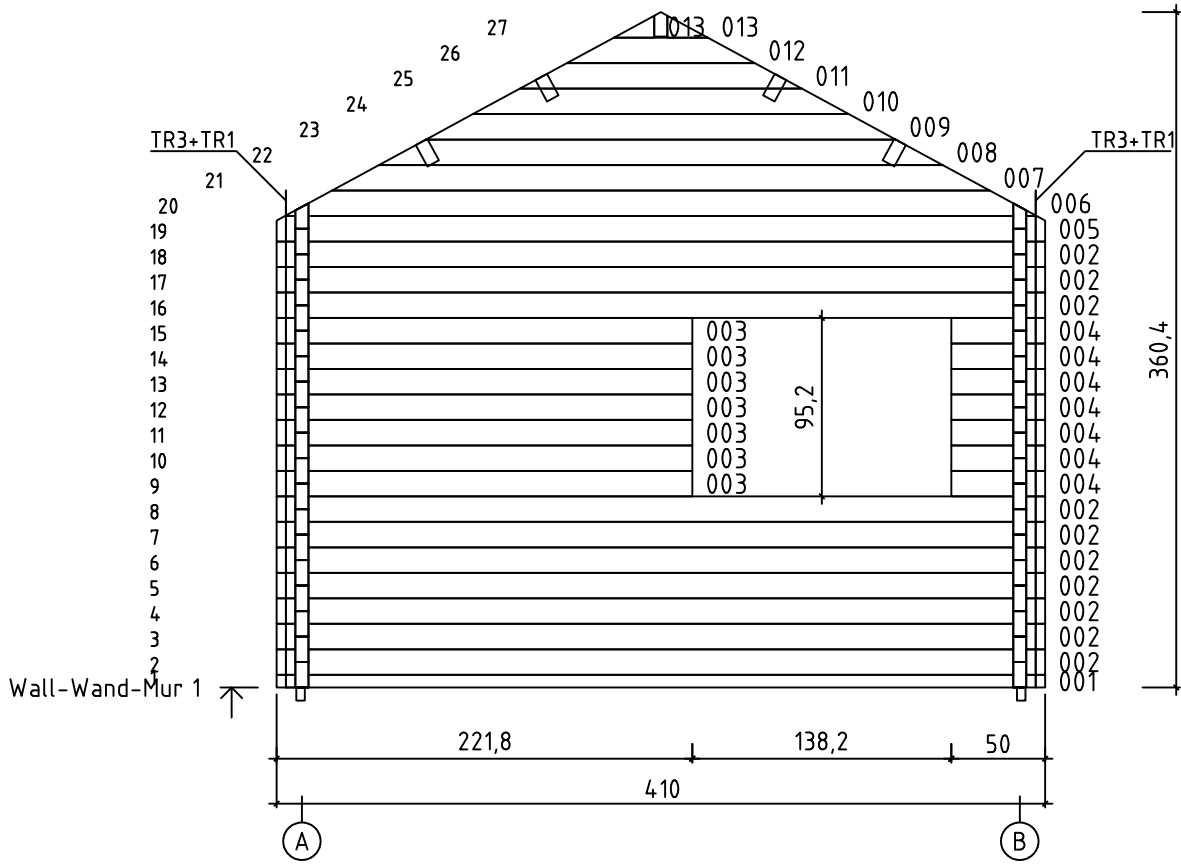

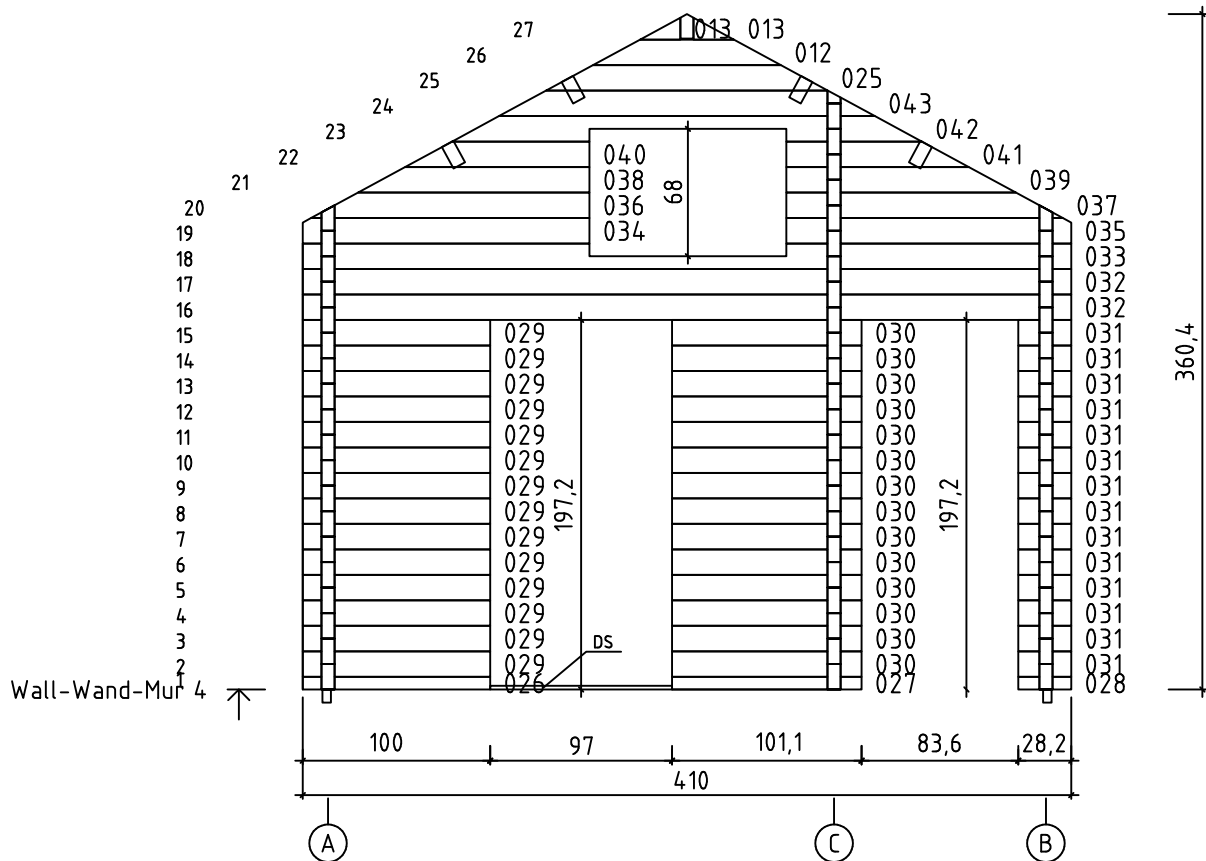

Wall-Wand-Mur 4

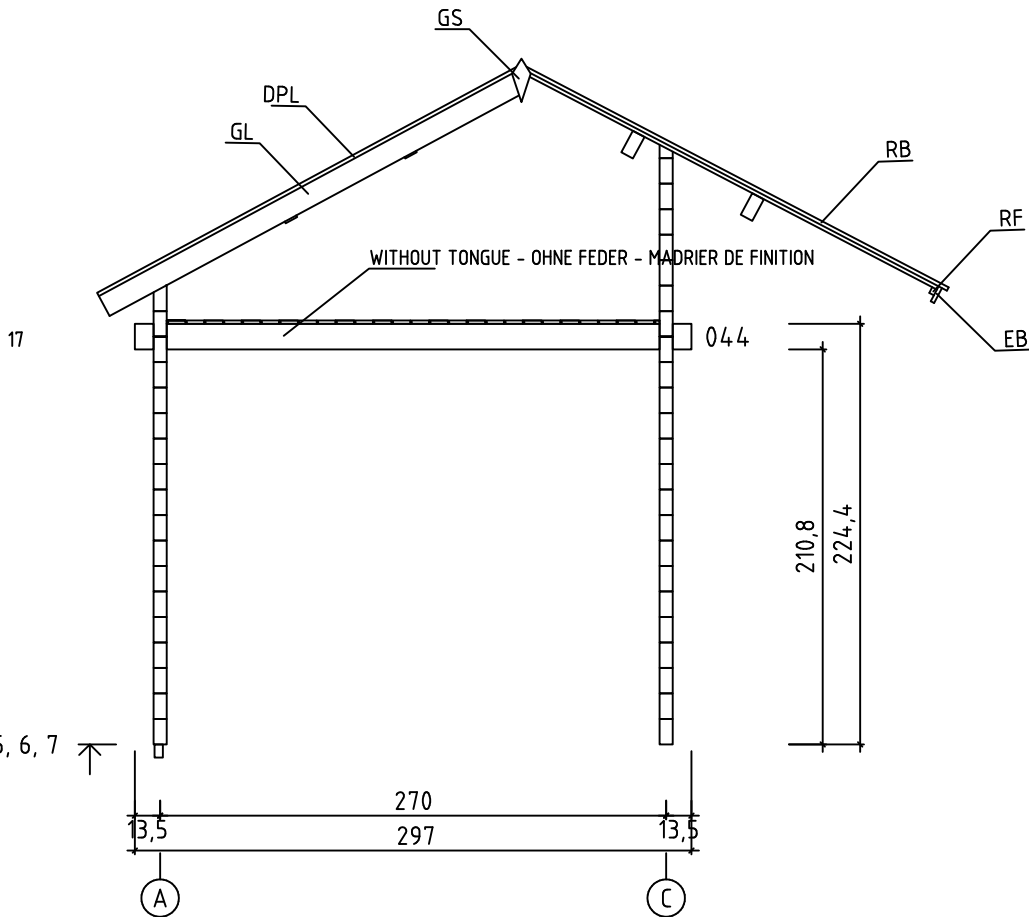

Wall-Wand-Mur 5, 6, 7

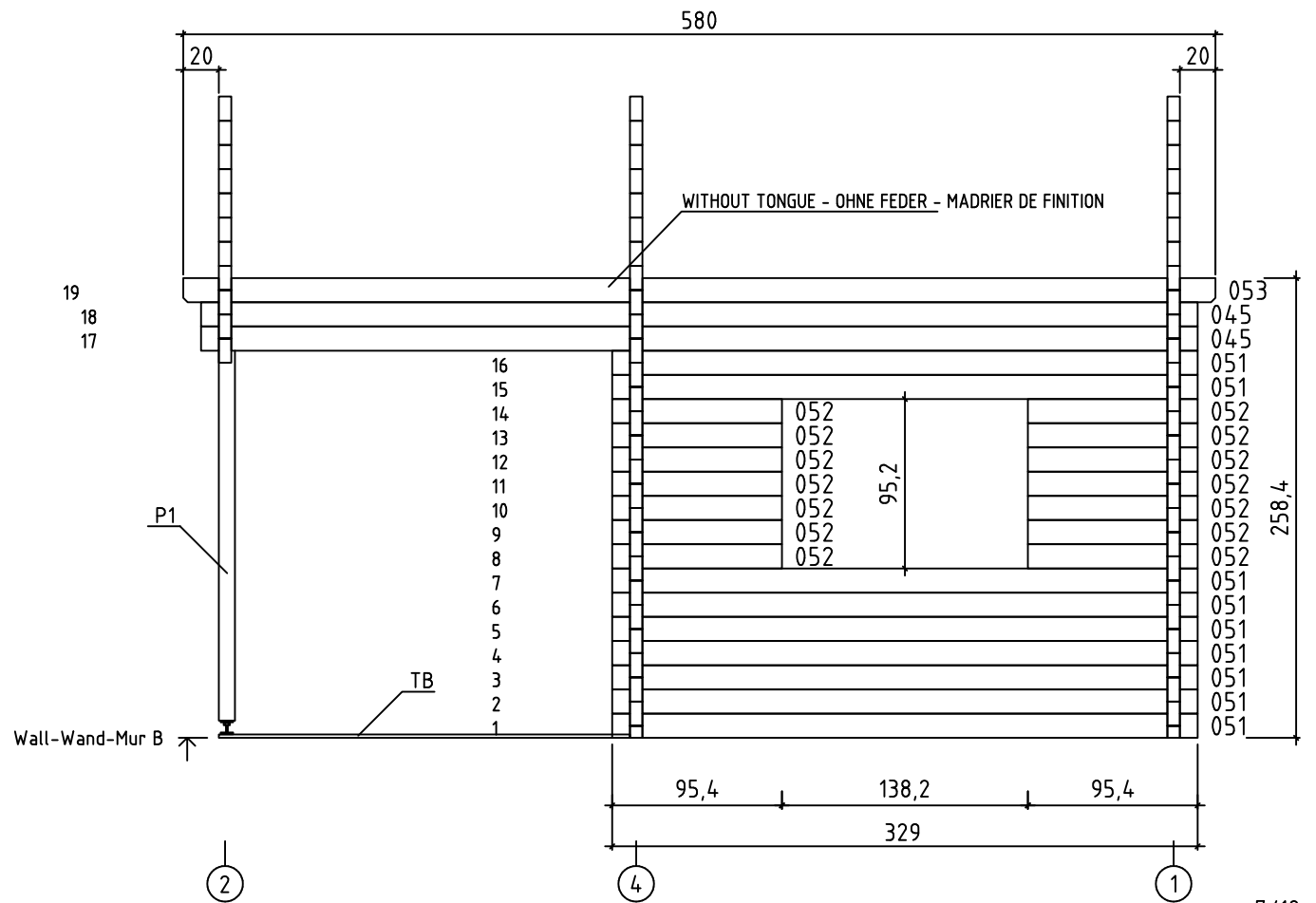
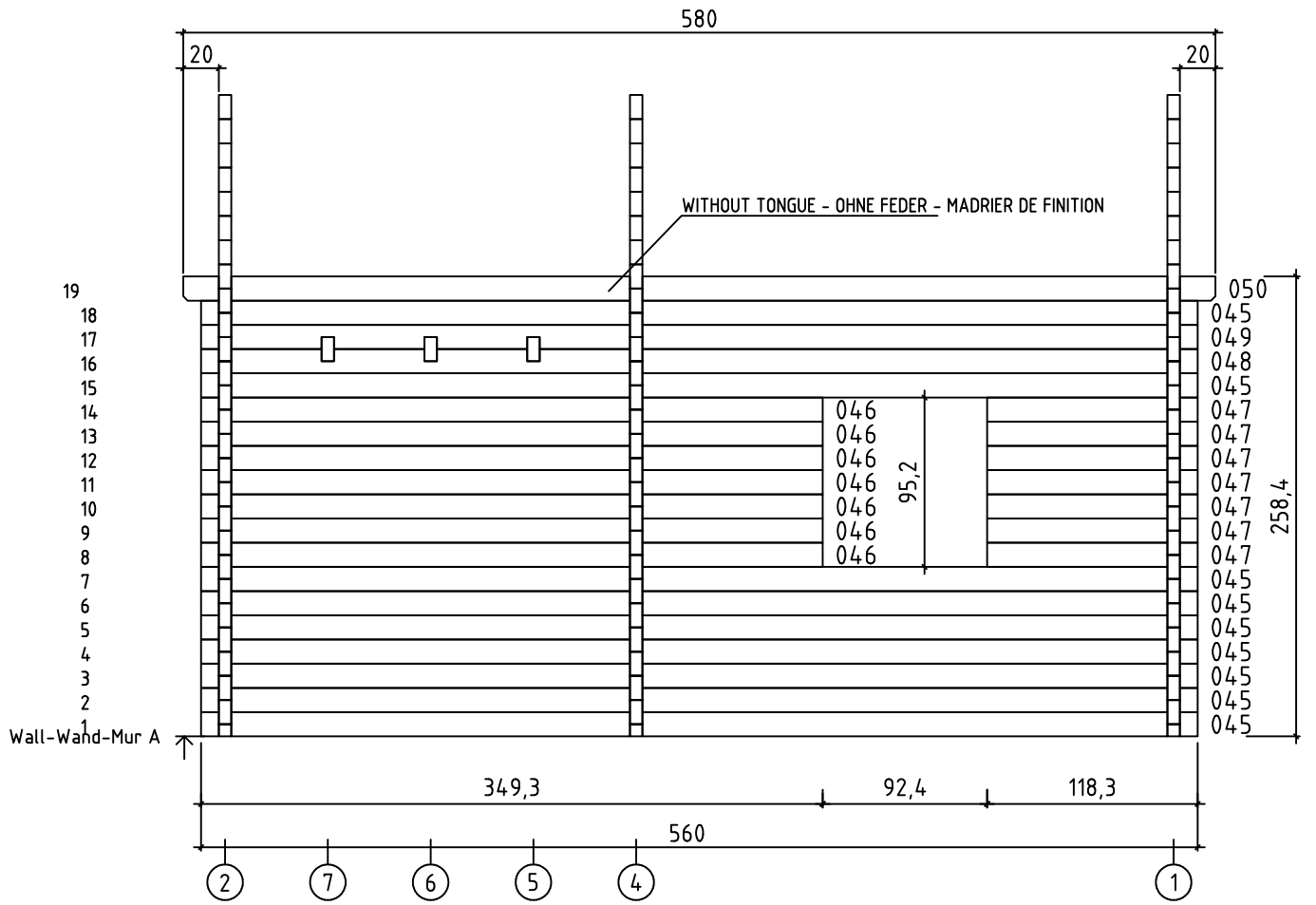

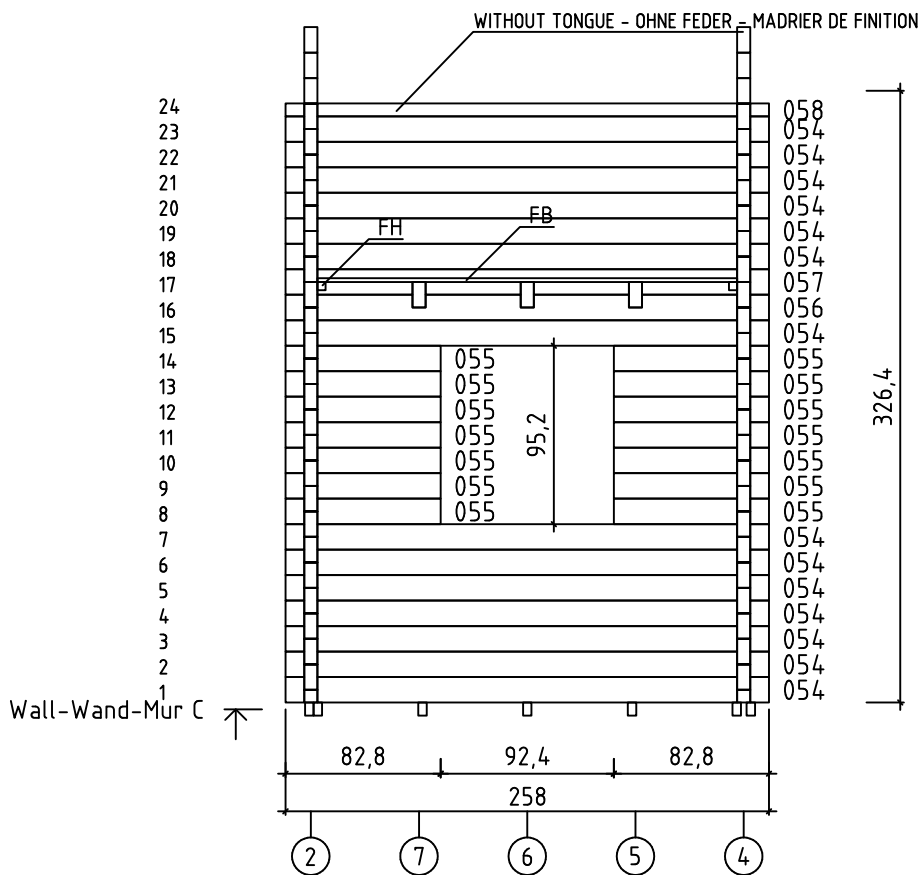



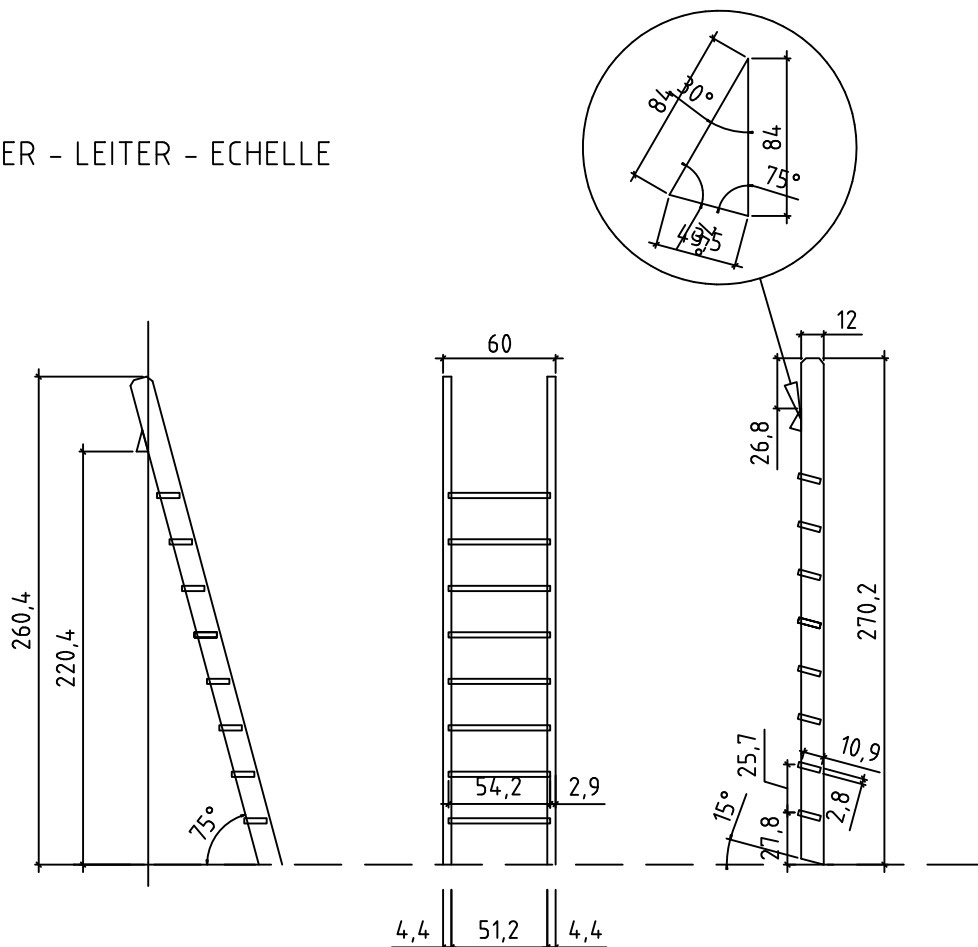



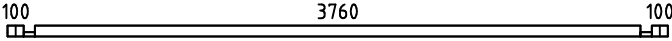
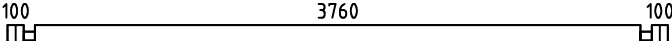
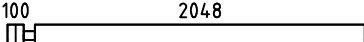

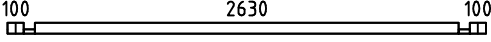
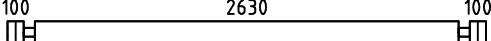
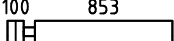
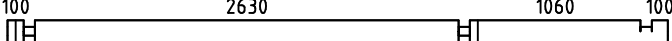
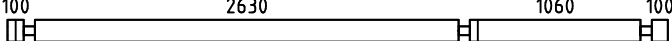
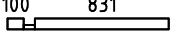
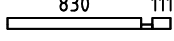

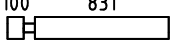
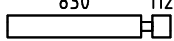

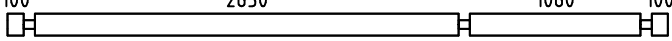
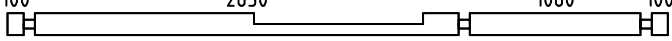
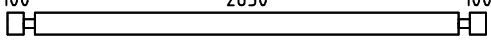
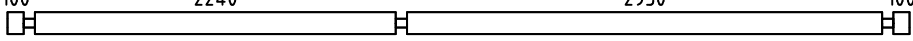
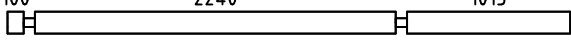
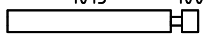
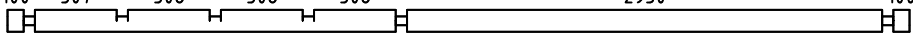
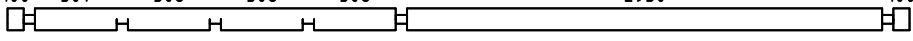
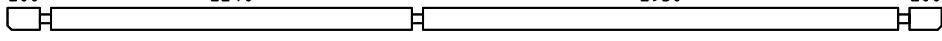
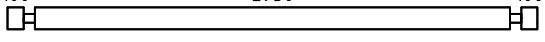

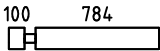
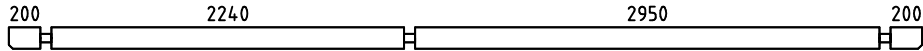
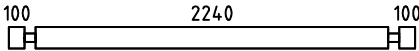
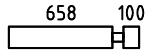
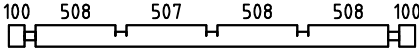
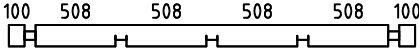
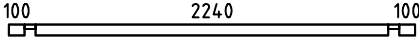
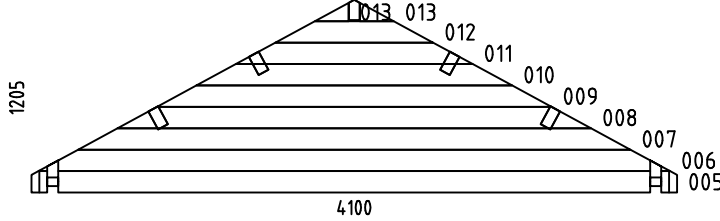
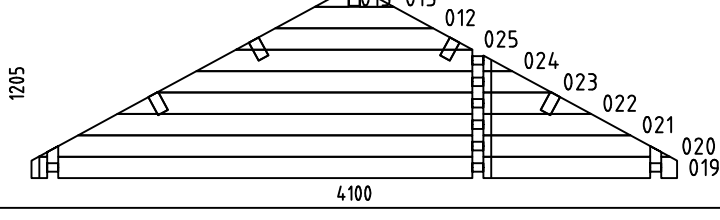
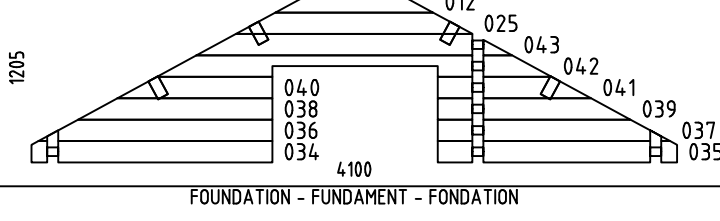



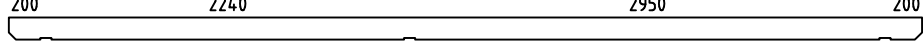
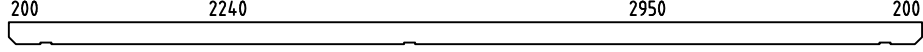







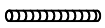

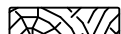

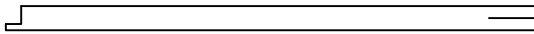
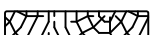

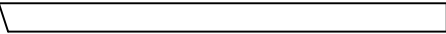



LADDER - LEITER - ECHELLE

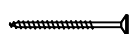

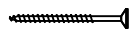
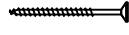

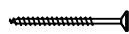





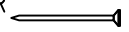
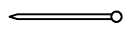

120x44 L= 2702 mm x 2
120x28 L= 542 mm x 8
120x44 L= 62.1 mm x 2

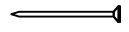
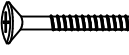
Pos	30.11.2010	ART.NR. 701302	9/12	Q.	P (mm)	L (mm)
001				1	70x68	4100
002				10	70x136	4100
003				7	70x136	2218
004				7	70x136	500
014				1	70x68	2970
015				8	70x136	2970
016				14	70x136	1023
017				1	70x136	4100
018				1	70x136	4100
026				1	70x68	1001
027				1	70x68	1011
028				1	70x68	282
029				14	70x136	1001
030				14	70x136	1011
031				14	70x136	282
032				2	70x136	4100
033				1	70x136	4100
044				3	70x136	2970
045				11	70x136	5600
046				7	70x136	3493
047				7	70x136	1183
048				1	70x136	5600
049				1	70x136	5600
050				1	70x136	5800
051				9	70x136	3290

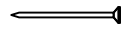
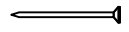
Pos	30.11.2010	ART.NR. 701302	10/12	Q.	P (mm)	L (mm)
052				14	70x136	954
053				1	70x136	5800
054				14	70x136	2580
055				14	70x136	828
056				1	70x136	2580
057				1	70x136	2580
058				1	70x69	2580
W1-1				1		
W2-1				1		
W4-1				1		
IAR3	FOUNDATION - FUNDAMENT - FONDATION 			13	45x70	3800
IAR2	FOUNDATION - FUNDAMENT - FONDATION 			2	45x70	3050
IAR1	FOUNDATION - FUNDAMENT - FONDATION 			2	45x70	2340
PR1	ROOF BEAM - DACHBALKEN - PANNE DE TOIT 			1	70x140	5800
PR1	ROOF BEAM - DACHBALKEN - PANNE DE TOIT 			4	70x140	5800
	FLOOR BOARDS - FUSSBODENBRETTER - LAME DE PLANCHER 			42	90x18	2946
FB	FLOOR BOARDS - FUSSBODENBRETTER - LAME DE PLANCHER 			60	90x18	2236
RB	ROOF BOARDS - DACHBRETTER - VOLIGES 			130	90x18	2500
TB	TERRACE BOARDS - TERRASSENBRETTER - PLANCHER DE TERRASSE 			12	90x19	2310
	FLOOR FILLET-FUSSBODENLEISTE - CORNIERE DE FINITION DU PLANCHER 				18x18	32.85

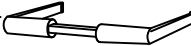
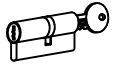
Pos	30.11.2010	ART.NR. 701302	11/12	Q.	P (mm)	L (mm)
TR1	TREADED ROD M12 - GEWINDESTANGE M12 - TIGE FILETÉE M12			3		540
TR2	TREADED ROD M12 - GEWINDESTANGE M12 - TIGE FILETÉE M12			1		1122
TR3	TREADED ROD M12 - GEWINDESTANGE M12 - TIGE FILETÉE M12			4		2000
DS	DOORSTEP - SWELLE - SEUIL DE PORTE			1	18x70	970
DPL	ROOFING FELT FILLET - DACHPAPPENLEISTE - BAGUETTE DE FIXATION DU FEUTRE BITUMEUX			4	18x58	2550
P1	POST - PFOSTEN - POTEAU			1	90x90	2095
EB	EAVES BOARD - TRAUFBRETT - BANDEAU DE TOIT			4	18x90	2900
RF	ROOF EDGE REINFORCEMENT - DACHRANDVERSTÄRKUNG - CORNIERE DE RENFORT DE BORD DE TOIT			4	28x34	2900
FH	FLOOR HOLDER - DACHBEFESTIGUNG - BAGUETTE DE SUPPORT DE PLAFOND			2	44x44	2628
GL	GABLE MOULDING - GIEBELLEISTE - PLANCHE DE RIVE			4	18x120	2550
	WINDOW HANDLE FITTINGS-FENSTERGRIF - POIGNÉE D'OUVERTURE DE FENETRE			5		
	LENGTHENING BOLT TREADED ROD - VERLÄNGERUNGSMUTTER FÜR GEWINDESTANGE - MANCHON DE RACCORDEMENT DE TIGE FILETÉE			4		
	DRIVE NUT TREADED ROD - EINSHLAGMUTTER FÜR GEWINDESTANGE - ÉCROU A FRAPPER POUR TIGE FILETÉE			4		
	NUT FOR TREADED ROD - MUTTER FÜR GEWINDESTANGE - ÉCROU POUR TIGE FILETÉE			4		
	PLAIN WASHER TREADED ROD - UNTERLEGSSCHEIBE FÜR GEWINDESTANGE - RONDELLE PLATE POUR TIGE FILETÉE			4		
	SCREW FOR GABLE SEGMENT - SCHRAUBEN FÜR DECKBLATT - VIS POUR FIXATION LOSANGE DE FINITION			4	3.5x35	
	SCREW FOR DOORSTEP - SCHRAUBEN FÜR SWELLE - VIS DE FIXATION DU SEUIL DE PORTE			3	3.5x50	
	SCREW FOR GABLE MOULDING - SCHRAUBEN FÜR GIEBELLEISTE - VIS DE FIXATION POUR PLANCHE DE RIVE			32	3.5x50	
	SCREW FOR FLOOR HOLDER - SCHRAUBE FÜR DACHBEFESTIGUNG VIS DE SUPPORT DE SOL			12	4.5x80	
	SCREW FOR STEPLADDER - SCHRAUBE FÜR LEITER VIS D'ASSEMBLAGE DES MARCHES DE L'ECHELLE			36	4x60	
	SCREW FOR POST - SCHRAUBEN FÜR PFOSTEN - VIS DE FIXATION DES POTEAUX			2	4.5x80	
	SCREW FOR EAVES BOARDS - SCHRAUBEN FÜR TRAUFBRETT - VIS DE FIXATION POUR BANDEAU DE TOIT			28	4x40	
	SCREW FOR ROOF EDGE REINFORCEMENT - SCHRAUBEN FÜR DACHRANDVERSTÄRKUNG - VIS POUR RENFORT DE BORD DE TOIT			28	4x40	
	SCREW FOR 1. WALL BEAM - SCHRAUBE FÜR 1. BOHLENREIHE - VIS DE FIXATION DES FONDATIONS			11	5x120	
	SCREW FOR ROOF BEAMS - SCHRAUBEN FÜR DACHBALKEN - VIS POUR PANNE DE TOIT			21	5x120	

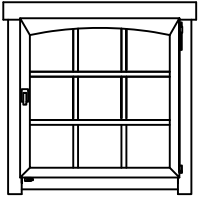
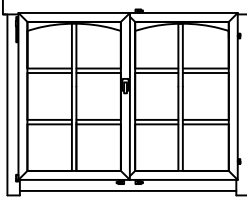
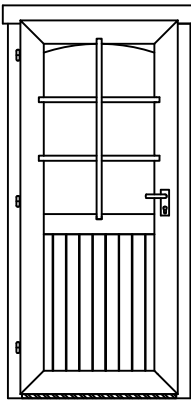
Pos	30.11.2010	ART.NR. 701302	12/12	Q.	P (mm)	L (mm)
	SCREW FOR GABLE - SCHRAUBEN FÜR GIEBEL - VIS POUR FIXATION DES PIGNONS			54	5x120	
	SCREW FOR FUNDAMENT - SCHRAUBEN ZUR BEFESTIGUNG FUNDAMENT - VIS POUR FONDATION			30	5x90	
	SCREW FOR POST HEIGHT ADJUSTMENT - SCHRAUBEN FÜR REGULIERUNGSSCHRAUBE FÜR PFOSTEN - VIS DE FIXATION DE SUPPORT RÉGLABLE DE POTEAU			8	6x50	
	ZN NAIL FOR TERRACE - ZN NÄGEL FÜR TERRASSENBRETT - POINTE POUR PLANCHER DE TERRASSE			120	2x50	
	ZN NAIL FOR FLOOR FILLET - ZN NÄGEL FÜR FUSSBODENLEISTE - POINTE POUR CORNIERE DE FINITION DU PLANCHER			66	1.4x40	
	HAMMER BLOCK - SCHLAGHOLZ - CALLE DE FRAPPE			1		
	ZN NAIL FOR ROOFING FELT FILLET - ZN NÄGEL FÜR DACHPAPPENLEISTE - POINTE POUR BAGUETTE FIXATION FEUTRE BITUMEUX			28	2x40	
	BOLT FOR WINDOW HANDLE FITTINGS - BOLZEN FÜR FENSTERGRIFF BESCHLAG - BOULON POUR POIGNÉE D'OUVERTURE DE FENETRE			10		
	LADDER - LEITER - ECHELLE			1		
GS	GABLE SEGMENT-DECKBLATT - LOSANGE DE FINITION			2		
	ZN NAIL FOR ROOF - ZN NÄGEL FÜR DACHBRETT - POINTE POUR TOIT			544	2x50	
	ZN NAIL FOR FLOOR - ZN NÄGEL FÜR FUSSBODENBRETT - CLOUS POUR PLANCHER			563	2x50	
	SET OF DOOR LOCK COVERS - SCHLOSSBLENDEN - SET DE GARNITURES DE SERRURE DE PORTE			1		
	DOOR HANDLE FITTINGS-TÜRGRIF - SET DE GARNITURES DE SERRURE DE PORTE			1		
	CYLINDER - ZYLINDERSCHLOSS - CYLINDRE DE SERRURE			1		
	POST HEIGHT ADJUSTMENT - REGULIERUNGSSCHRAUBE FÜR PFOSTEN - SUPPORT RÉGLABLE DE POTEAU			1		
	WINDOW-FENSTER-FENETRE 916x916		AK.1.109.PSP.K7	3		
	WINDOW-FENSTER-FENETRE 1374x916		TAK.1.106.PSV.K7	2		
	DOOR-TÜR-PORTE 827x1933		UK.2.056.PVV.MMK7	1		