

Brighton 44
Art. Nr. 4416902
1/10

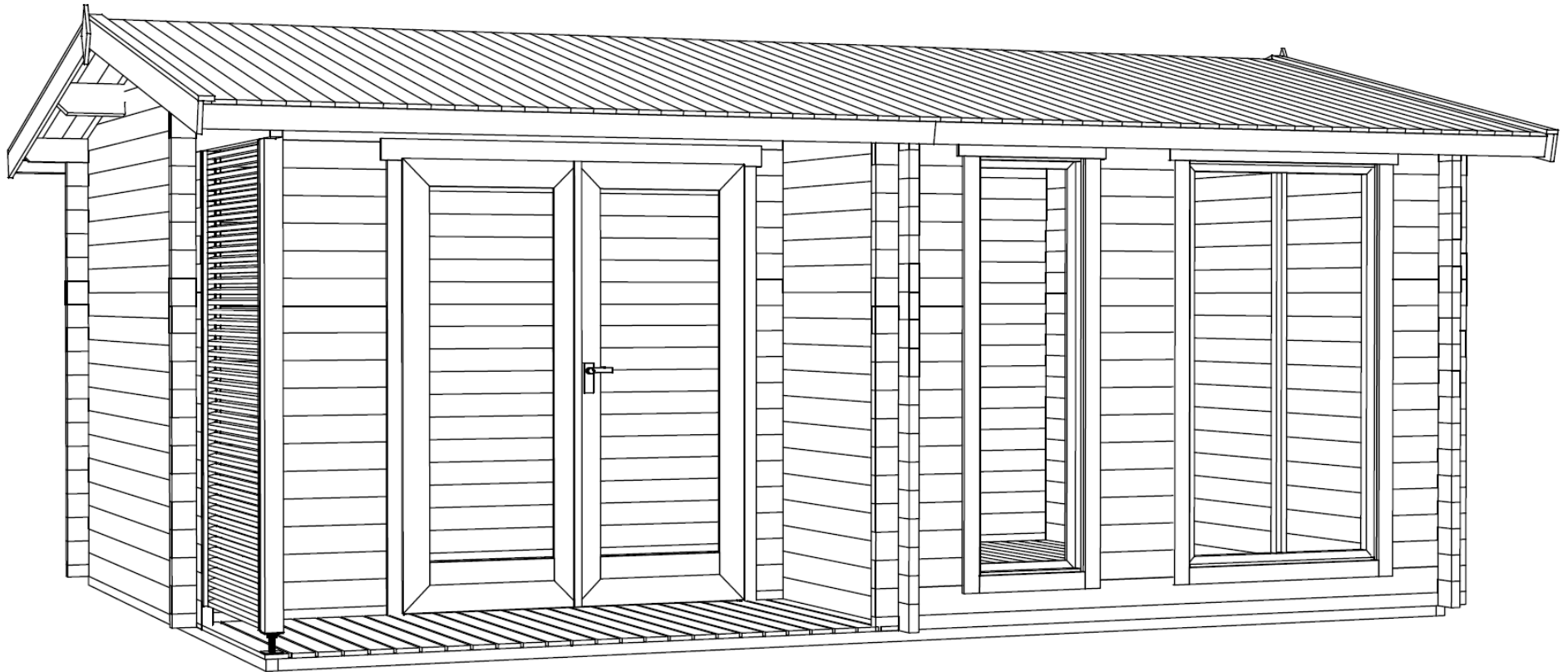

Art.Nr. 4416902
GROUNDPLAN - GRUNDPLAN - PLAN DE MASSE

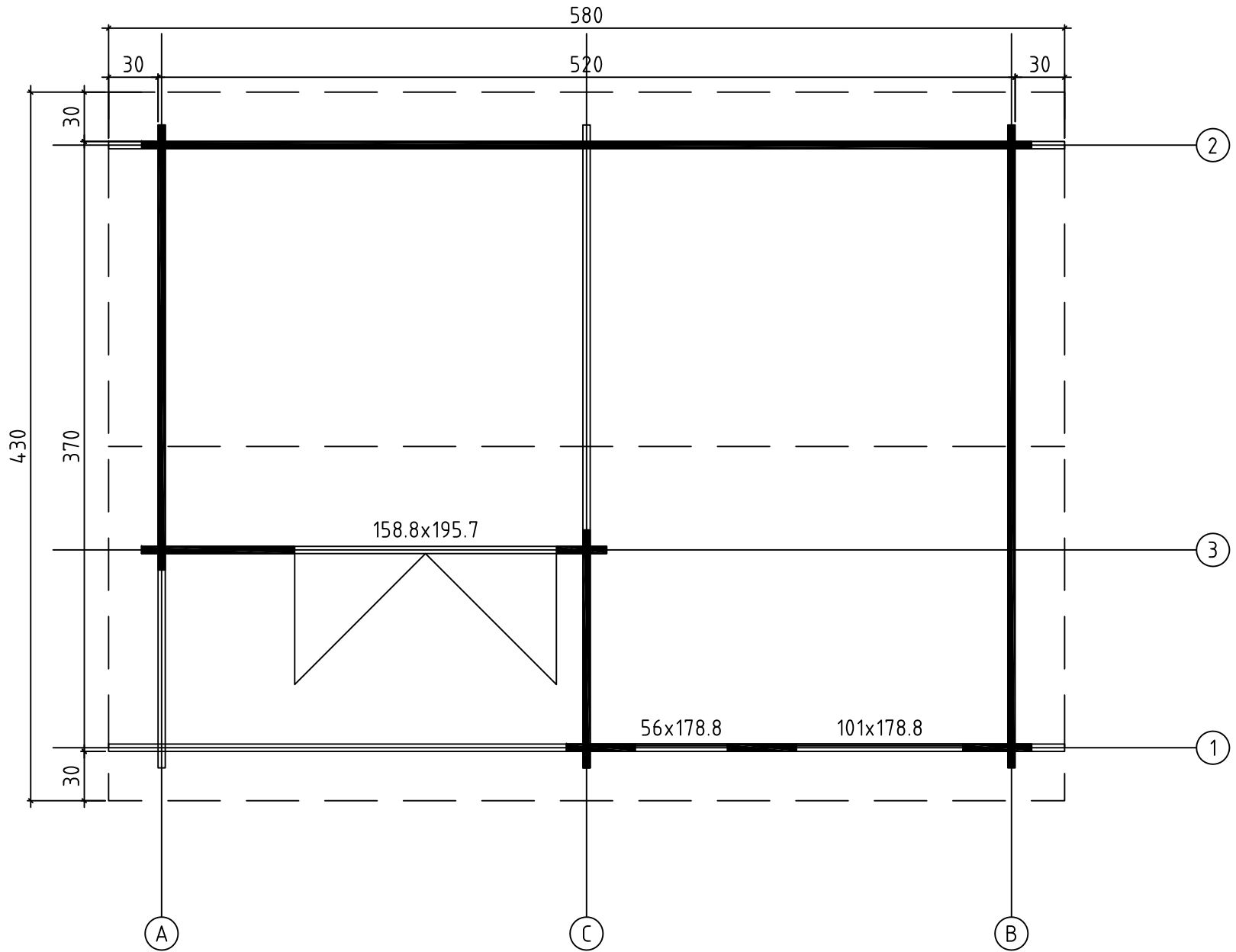

Art.Nr. 4416902
FOUNDATION - FUNDAMENT - FONDATION

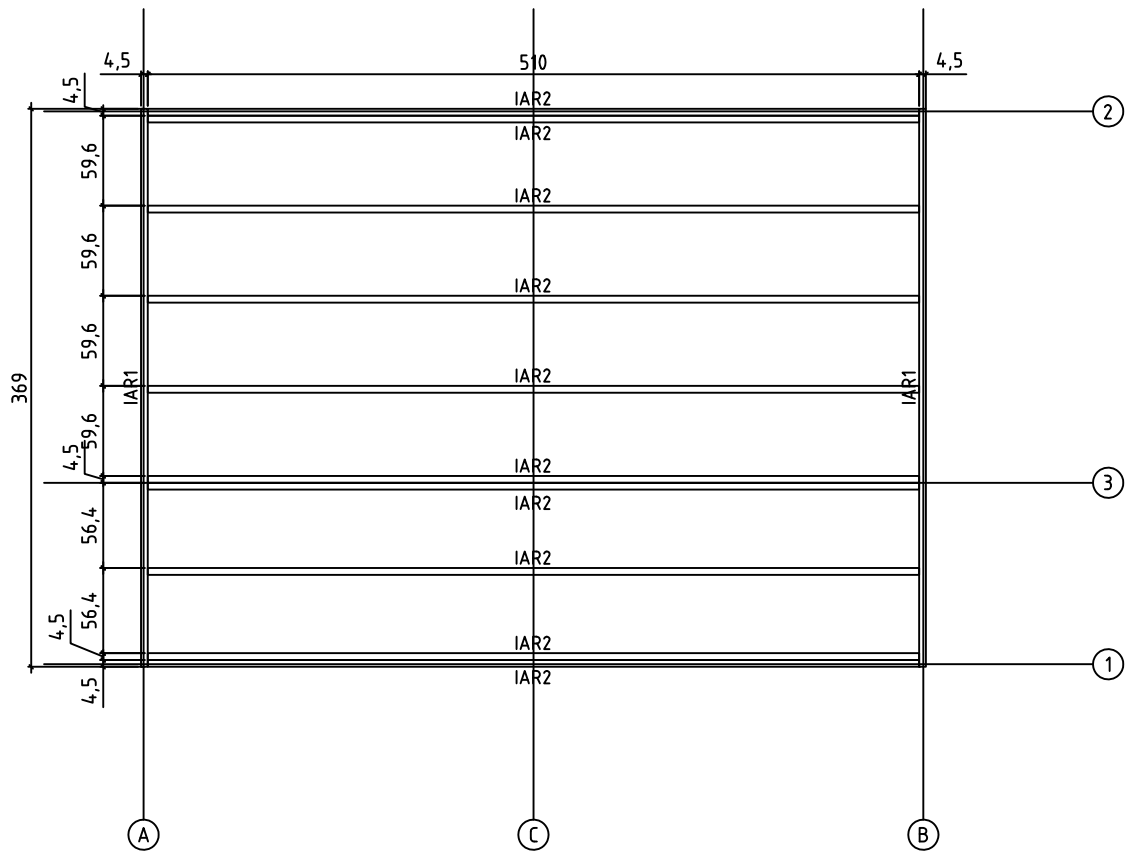

FLOOR BOARDS - FUSSBODENBRETTNER - LAME DE PLANCHER
TERRACE BOARDS - TERRASSENBRETTNER - PLANCHER DE TERRASSE

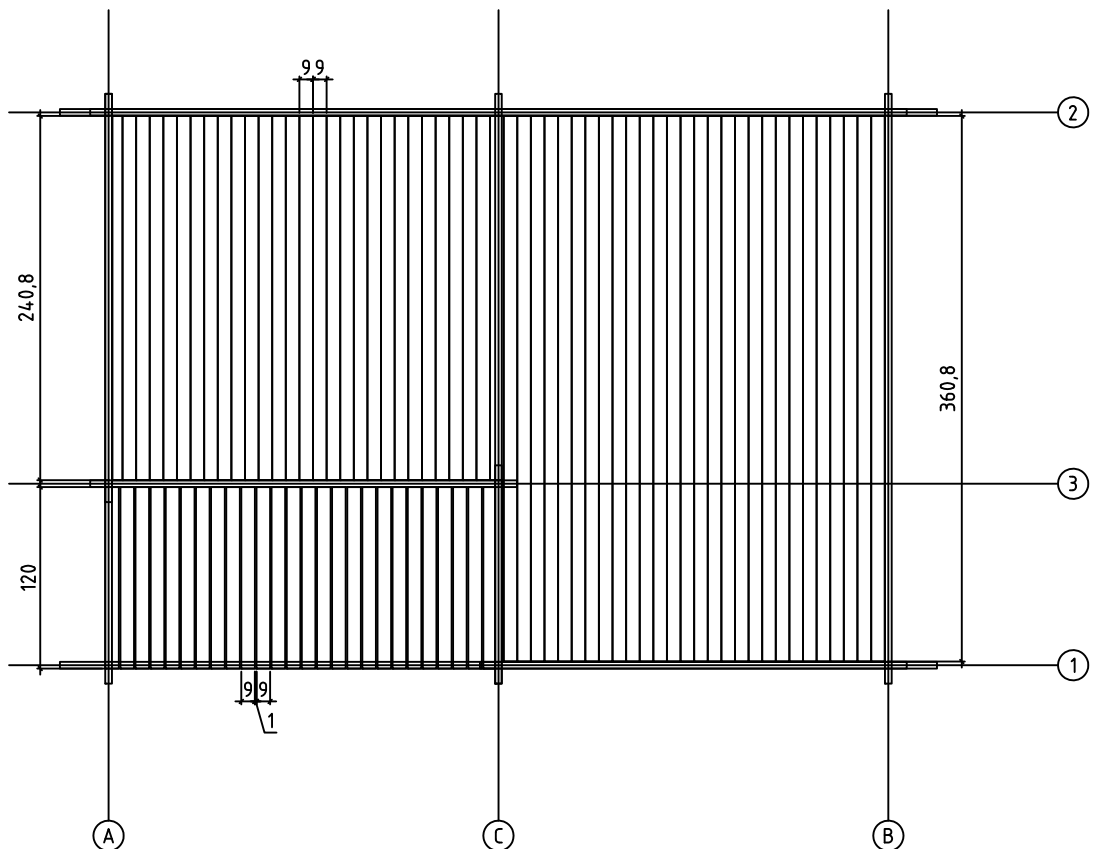

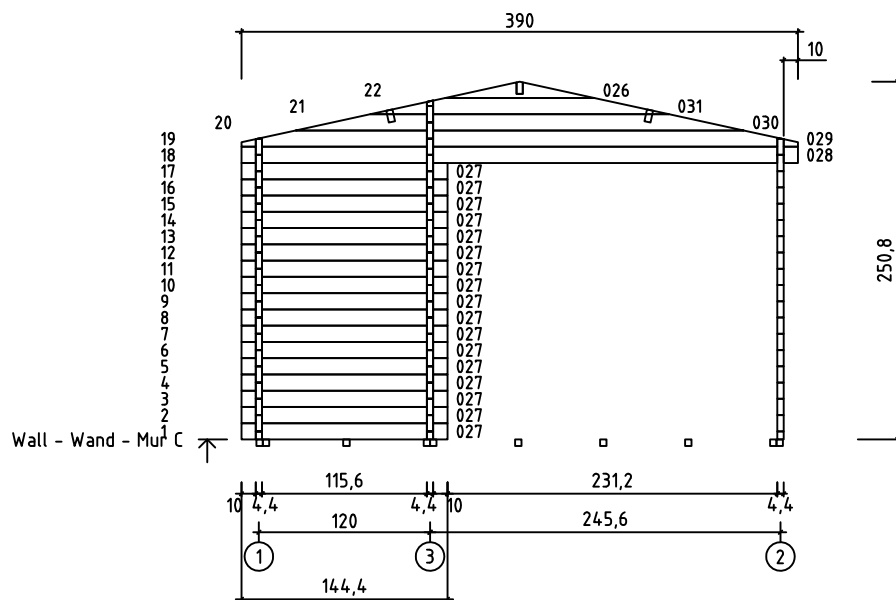
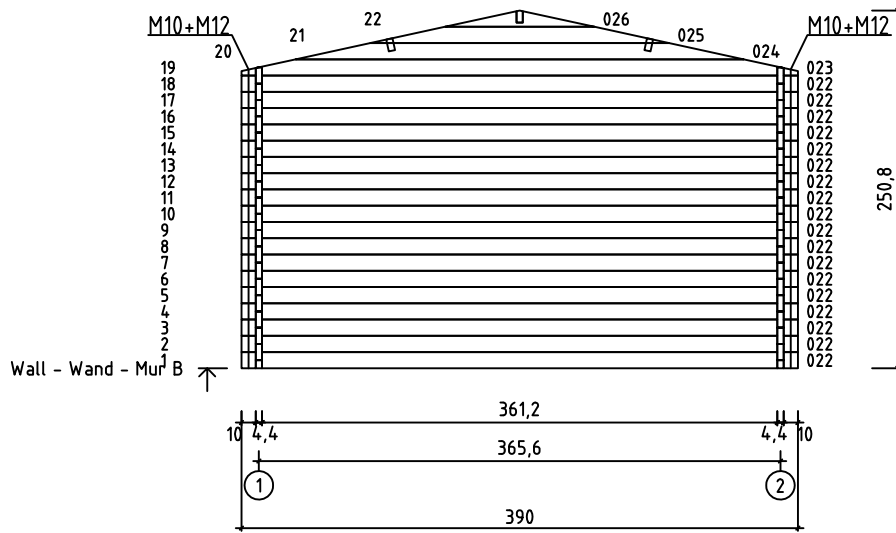
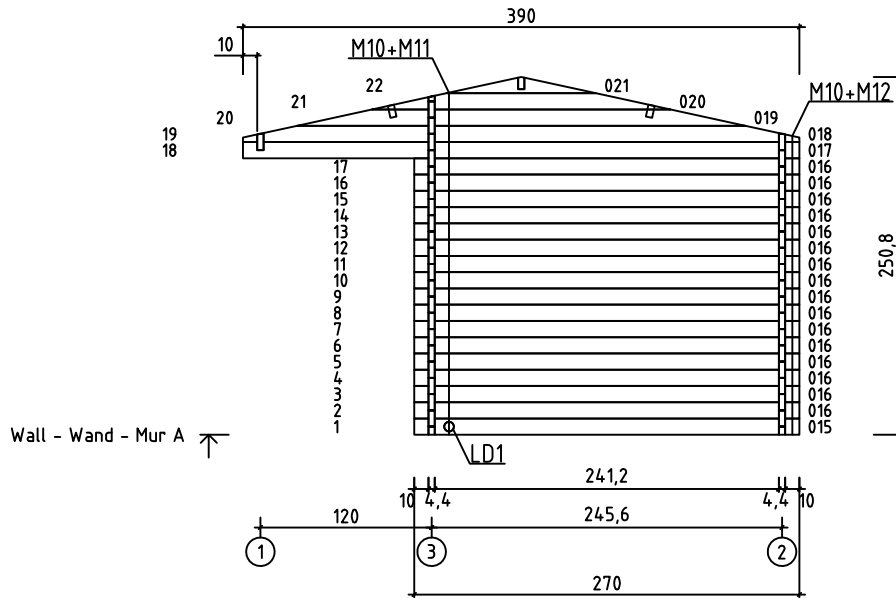

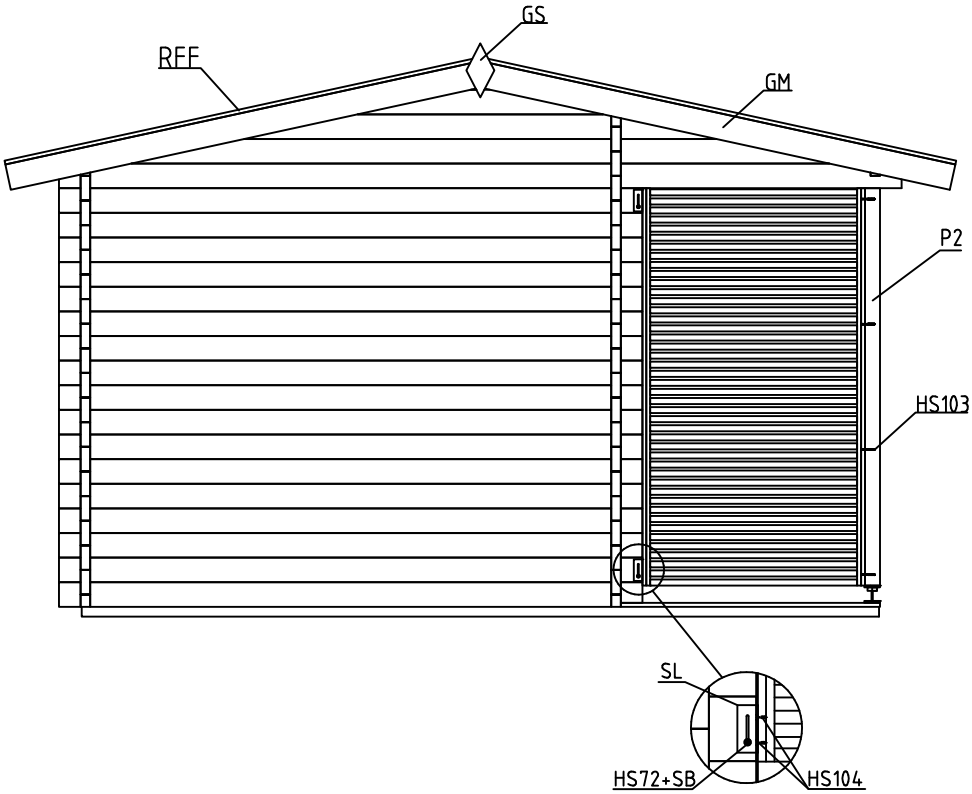



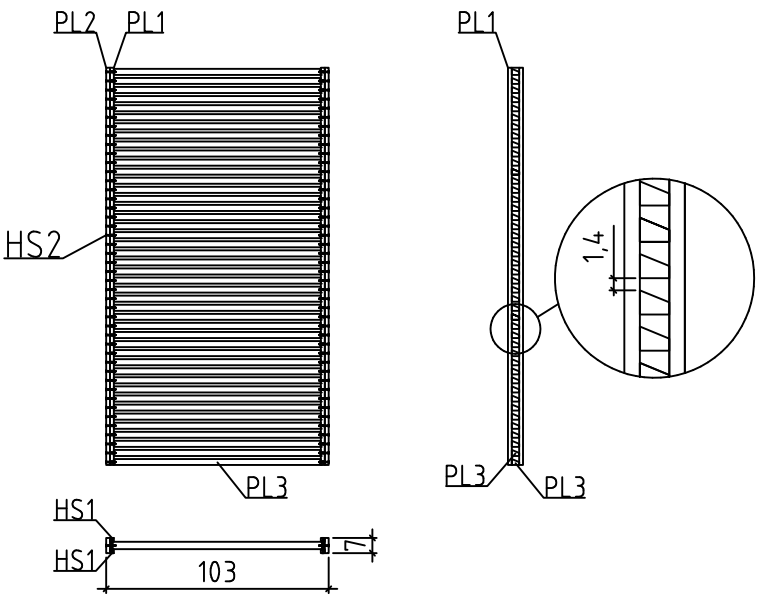

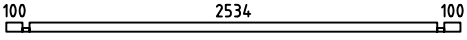
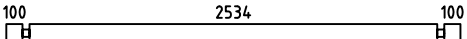

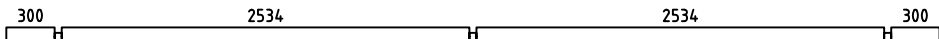
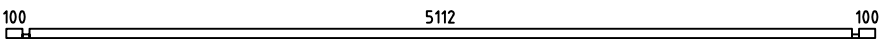
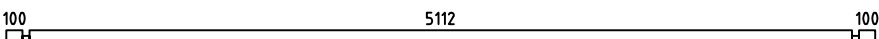
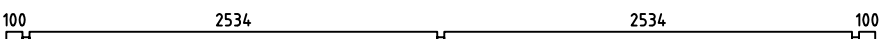

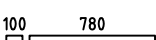

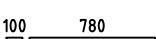

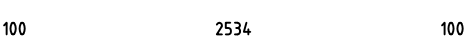
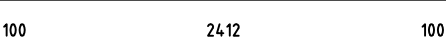
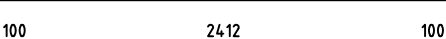
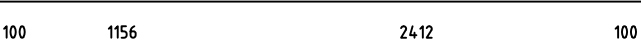
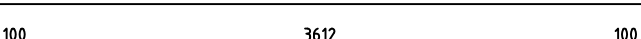
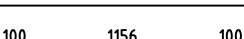
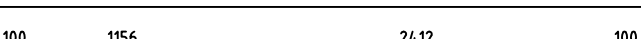
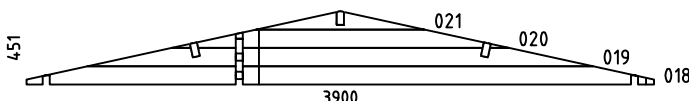
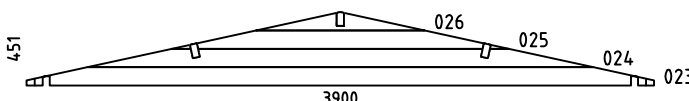



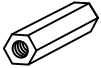
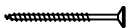

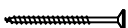
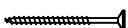



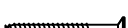















TERRACE RAILING -
TERRASSE GARDE -
CORPS DE TERRASSE

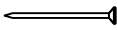
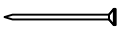

Pos	7.10.2014	Piece list - Stückliste - Liste des pièces Art.Nr. 4416902	7/10	Q.	P (mm)	L (mm)
001				1	44x57	2822
002				4	44x114	2822
003				32	44x114	416
004				16	44x114	416
005				1	44x114	5800
006				1	44x57	5400
007				16	44x114	5400
008				1	44x114	5400
009				1	44x114	5800
010				1	44x57	924
011				1	44x57	300
012				17	44x114	924
013				17	44x114	300
014				1	44x39	2822
015				1	44x114	2700
016				16	44x114	2700
017				1	44x114	3900
022				18	44x114	3900
027				17	44x114	1444
028				1	44x114	3900
WA-1				1		
WB-1				1		

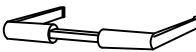
Pos	7.10.2014	Piece list - Stückliste - Liste des pièces Art.Nr. 4416902	8/10	Q.	P (mm)	L (mm)
WC-1				1		
IAR2		FOUNDATION - FUNDAMENT - FONDATION 		10	45x45	5100
IAR1		FOUNDATION - FUNDAMENT - FONDATION 		2	45x45	3690
PR1		ROOF BEAM - DACHBALKEN - PANNE DE TOIT 		1	44x140	5800
A-PR1		ROOF BEAM - DACHBALKEN - PANNE DE TOIT 		2	44x140	5800
		FLOOR BOARDS - FUSSBODENBRETTER - LAME DE PLANCHER 		29	90x18	3608
		FLOOR BOARDS - FUSSBODENBRETTER - LAME DE PLANCHER 		28	90x18	2408
		TERRACE BOARDS - TERRASSENBRETTER - PLANCHER DE TERRASSE 		26	90x19	1200
		ROOF BOARDS - DACHBRETTER - VOLIGES 		130	90x18	2200
		FLOOR FILLET - FUSSBODENLEISTE - CORNIERE DE FINITION DU PLANCHER 			18x18	17.43
RFF		ROOFING FELT FILLET - DACHPAPPENLEISTE - BAGUETTE DE FIXATION DU FEUTRE BITUMEUX 		4	18x58	2250
M12		TREADED ROD M10 - GEWINDESTANGE M10 - TIGE FILETÉE M10 		3		125
M11		TREADED ROD M10 - GEWINDESTANGE M10 - TIGE FILETÉE M10 		1		371
M10		TREADED ROD M10 - GEWINDESTANGE M10 - TIGE FILETÉE M10 		4		2000
PL1		FILLE FOR TERRACE RAILING - LEISTE FÜR TERRASSE - BAGUETTE POUR CORPS DE TERRASSE 		4	18x18	1839
PL2		FILLE FOR TERRACE RAILING - LEISTE FÜR TERRASSE - BAGUETTE POUR CORPS DE TERRASSE 		2	18x70	1839
PL3		FILLE FOR TERRACE RAILING - LEISTE FÜR TERRASSE - BAGUETTE POUR CORPS DE TERRASSE 		44	28x34	994
P2		POST - PFOSTEN - POTEAU 		1	70x70	1896
		FASCIA BOARD - TRAUFBRETT - BANDEAU DE TOIT 		4	18x90	2900
		ROOF EDGE REINFORCEMENT - DACHRANDVERSTÄRKUNG - CORNIERE DE RENFORT DE BORD DE TOIT 		4	28x34	2900
GM		GABLE MOULDING - GIEBELLEISTE - PLANCHE DE RIVE 		4	18x120	2250
		WINDOW HANDLE FITTINGS - FENSTERGRIFF - POIGNÉE D'OUVERTURE DE FENETRE 		2		
		BOLT FOR WINDOW HANDLE FITTINGS - BOLZEN FÜR FENSTERGRIFF BESCHLAG - BOULON POUR POIGNÉE D'OUVERTURE DE FENETRE 		4		
LD1		LID FOR TREADED ROD HOLE - ABDECKUNG FÜR GEWINDESTANGENÖFFNUNG - COUVERCLE POUR ACCÈS RÉGLAGÉ TIGE FILETÉE 		1		

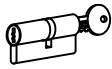
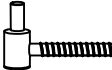
Pos	7.10.2014	Piece list - Stückliste - Liste des pièces Art.Nr. 4416902	9/10	Q.	P (mm)	L (mm)
		LENGTHENING BOLT FOR TREADED ROD - VERLÄNGERUNGSMUTTER FÜR GEWINDESTANGE - MANCHON DE RACCORDEMENT DE TIGE FILETÉE		4		
HS104		SCREW FOR SLIDING WALL TIE - SCHIEBEREGLER FÜR WAND - SABOT MÉTALLIQUE POUR FIXATION MUR		8	3.5x20	
		SCREW FOR GABLE SEGMENT - SCHRAUBEN FÜR DECKBLATT - VIS POUR FIXATION LOSANGE DE FINITION		4	3.5x35	
		SCREW FOR POST - SCHRAUBEN FÜR PFOSTEN - VIS DE FIXATION DES POTEAUX		2	3.5x50	
		SCREW FOR GABLE MOULDING - SCHRAUBEN FÜR GIEBELLEISTE - VIS DE FIXATION POUR PLANCHE DE RIVE		24	3.5x50	
HS1		SCREW FOR FIXING TERRACE RAILING - SCHRAUBE FÜR TERRASSE VIS DE FIXATION DE GARDE-CORPS DE TERRASSE		20	3x30	
		SCREW FOR DOOR FILLET - SCHRAUBE ZUR BEFESTIGUNG TÜRLEISTE - VIS D'ASSEMBLAGE DU CADRE DE PORTE		5	3x30	
HS2		SCREW FOR FIXING TERRACE RAILING - SCHRAUBE FÜR TERRASSE VIS DE FIXATION DE GARDE-CORPS DE TERRASSE		88	4x40	
		SCREW FOR FASCIA BOARDS - SCHRAUBEN FÜR TRAUFBRETTER - VIS DE FIXATION POUR BANDEAU DE TOIT		28	4x40	
		SCREW FOR ROOF EDGE REINFORCEMENT - SCHRAUBEN FÜR DACHRANDVERSTÄRKUNG - VIS POUR RENFORT DE BORD DE TOIT		28	4x40	
HS103		SCREW FOR FIXING TERRACE RAILING - SCHRAUBE FÜR TERRASSE VIS DE FIXATION DE GARDE-CORPS DE TERRASSE		4	4.5x80	
		SCREW FOR ROOF BEAMS - SCHRAUBEN FÜR DACHBALKEN - VIS POUR PANNE DE TOIT		17	5x120	
		SCREW FOR GABLE - SCHRAUBEN FÜR GIEBEL - VIS POUR FIXATION DES PIGNONS		16	5x120	
		SCREW FOR 1. WALL BEAM - SCHRAUBE FÜR 1. BOHLENREIHE - VIS DE FIXATIONS 1ERE RANGÉE DE MADRIERS AVEC POUTRELLES DE FONDATIONS		10	5x90	
		SCREW FOR FOUNDATION - SCHRAUBEN ZUR BEFESTIGUNG FUNDAMENT - VIS DE FIXATIONS DES POUTRELLES DE FONDATIONS		32	5x90	
		SCREW FOR DOOR JAMB - SCHRAUBE FÜR TÜRRAHMEN - VIS DE FIXATION POUR MONTANT DE PORTE		4	5x90	
HS72		SCREW FOR SLIDING WALL TIE - SCHIEBEREGLER FÜR WAND - SABOT MÉTALLIQUE POUR FIXATION MUR		2	6x40	
		SCREW FOR POST HEIGHT ADJUSTMENT - SCHRAUBEN FÜR REGULIERUNGSSCHRAUBE FÜR PFOSTEN - VIS DE FIXATION DE SUPPORT REGLABLE DE POTEAU		8	6x50	
		SCREW FOR DOORSTEP - SCHRAUBEN FÜR SWELLE - VIS DE FIXATION DU SEUIL DE PORTE		3	4.5x65	
		ZN NAIL FOR FLOOR FILLET - ZN NÄGEL FÜR FUSSBODENLEISTE - POINTE POUR CORNIERE DE FINITION DU PLANCHER		35	1.4x40	
		HAMMER BLOCK - SCHLAGHOLZ - CALLE DE FRAPPE		1		
		DRIVE NUT TREADED ROD - EINSHLAGMUTTER FÜR GEWINDESTANGE - ÉCROU A FRAPPER POUR TIGE FILETÉE		4		
		NUT FOR TREADED ROD - MUTTER FÜR GEWINDESTANGE - ÉCROU POUR TIGE FILETÉE		4		
		ZN NAIL FOR TERRACE - ZN NÄGEL FÜR TERRASSENBRETT - POINTE POUR PLANCHER DE TERRASSE		156	2.1x50	
		ZN NAIL FOR ROOF - ZN NÄGEL FÜR DACHBRETT - POINTES DE FIXATIONS DES VOLIGES DE TOIT		404	2x50	

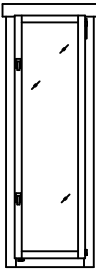
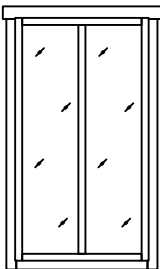
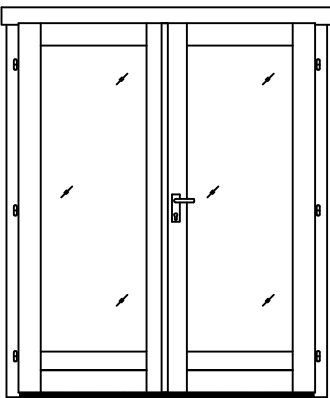
Pos	7.10.2014	Piece list - Stückliste - Liste des pièces Art.Nr. 4416902	10/10	Q.	P (mm)	L (mm)
		ZN NAIL FOR FLOOR - ZN NÄGEL FÜR FUSSBODENBRETT - CLOUS POUR PLANCHER		350	2x50	
		ZN NAIL FOR ROOFING FELT FILLET - ZN NÄGEL FÜR DACHPAPPENLEISTE - POINTE POUR BAGUETTE FIXATION FEUTRE BITUMEUX		24	2x40	
GS		GABLE SEGMENT - DECKBLATT - LOSANGE DE FINITION		2		
		PLAIN WASHER TREADED ROD - UNTERLEGSSCHEIBE FÜR GEWINDESTANGE - RONDELLE PLATE POUR TIGE FILETÉE		4		
SB		PLAIN WASHER - UNTERLEGSSCHEIBE - RONDELLE PLATE		2		
SL		SLIDING WALL TIE - SCHIEBEREGLER FÜR WAND - SABOT MÉTALLIQUE POUR FIXATION MUR		2		
		DOOR HANDLE FITTINGS - TÜRGRIFF - SET DE GARNITURES DE SERRURE DE PORTE		1		
		SET OF DOOR LOCK COVERS - SCHLOSSBLENDEN - SET DE GARNITURES DE SERRURE DE PORTE		1		
		CYLINDER LOCK - ZYLINDERSCHLOSS - CYLINDRE DE SERRURE		1		
		MALE BOLT HINGE FOR DOOR - TÜRRIEGEL - PARTIE MALE DE CHARNIERE DE PORTE		6		
		POST HEIGHT ADJUSTMENT - REGULIERUNGSSCHRAUBE FÜR PFOSTEN - SUPPORT RÉGLABLE DE POTEAU		1		
		WINDOW - FENSTER - FENETRE 560x1788		AK.1.100.PSP DGP	1	
		WINDOW - FENSTER - FENETRE 1010x1788		TAK.1.100.PM0.e DGP	1	
		DOOR - TÜR - PORTE 1588x1957		TUK.1.100.PVP.MM DGP	1	