

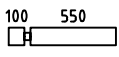

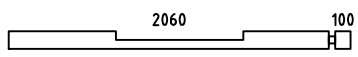
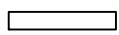
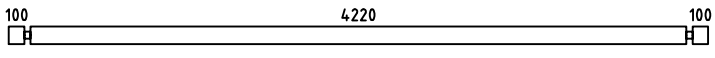
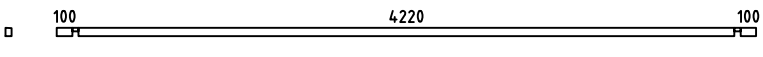
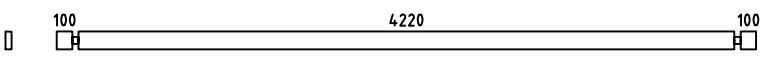
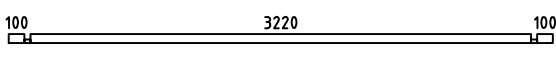
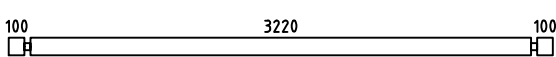
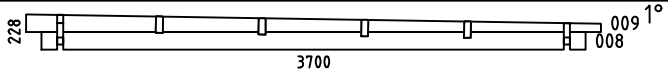
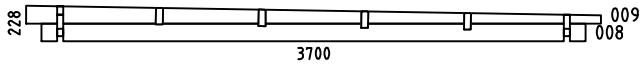
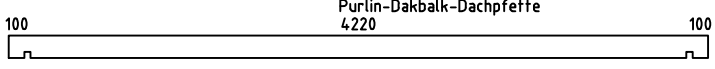

Charlie40 ISO

| Pos                   | Specification-Spezifikation-Specificatie                                                                                                    | St.  | Profile (mm)      | Length (mm) |
|-----------------------|---------------------------------------------------------------------------------------------------------------------------------------------|------|-------------------|-------------|
| 001                   |                                                            | 33   | 40x114            | 690         |
| 002                   |                                                            | 1    | 40x114            | 2200        |
| 003                   |                                                            | 16   | 40x114            | 690         |
| 004                   |                                                           | 20   | 40x114            | 4500        |
| 005                   |                                                           | 1    | 40x54             | 4500        |
| 006                   |                                                           | 1    | 40x114            | 4500        |
| 007                   |                                                            | 2    | 40x57             | 3500        |
| 008                   |                                                            | 34   | 40x114            | 3500        |
| WA-1                  |                                                           | 1    |                   |             |
| WB-1                  |                                                           | 1    |                   |             |
| PR1                   |                                                          | 4    | 44x14.4           | 4500        |
| DP-1                  | Roof board-Dachbrett-Dakplank                          | 52   | 88x18             | 3700        |
| L-1                   | Eave Board-Traufenblende-Afdeklank                     | 2    | 18x120            | 4540        |
| L-2                   | Facia Board-Giebelblende-Gevelplank                    | 2    | 18x120            | 3740        |
|                       | Double Door Set ISO-Doppeltür<br>Satz-Dubbele Deur Set  | 1    |                   |             |
| W0 8<br>0x18<br>5 ISO | WINDOW 800x1850 ISO TEMPERED<br>                         | 1    |                   |             |
|                       |                                                                                                                                             |      |                   |             |
|                       |                                                                                                                                             |      |                   |             |
|                       |                                                                                                                                             |      |                   |             |
|                       |                                                                                                                                             |      |                   |             |
| Kood                  | Materjal                                                                                                                                    | File | Charlie40 ISO.dwg | Leht 1/2    |

| Pos                    | Specification-Spezifikation-Specificatie                                                                                                         | St.                    | Profile (mm) | Length (mm) |
|------------------------|--------------------------------------------------------------------------------------------------------------------------------------------------|------------------------|--------------|-------------|
| DD08<br>160x190<br>ISO | <p style="text-align: center;">DOOR 1600x1900 ISO TEMPERED</p>  | 1                      |              |             |
|                        |                                                                                                                                                  |                        |              |             |
|                        |                                                                                                                                                  |                        |              |             |
|                        |                                                                                                                                                  |                        |              |             |
|                        |                                                                                                                                                  |                        |              |             |
|                        |                                                                                                                                                  |                        |              |             |
|                        |                                                                                                                                                  |                        |              |             |
|                        |                                                                                                                                                  |                        |              |             |
|                        |                                                                                                                                                  |                        |              |             |
|                        |                                                                                                                                                  |                        |              |             |
|                        |                                                                                                                                                  |                        |              |             |
|                        |                                                                                                                                                  |                        |              |             |
|                        |                                                                                                                                                  |                        |              |             |
|                        |                                                                                                                                                  |                        |              |             |
|                        |                                                                                                                                                  |                        |              |             |
|                        |                                                                                                                                                  |                        |              |             |
|                        |                                                                                                                                                  |                        |              |             |
|                        |                                                                                                                                                  |                        |              |             |
|                        |                                                                                                                                                  |                        |              |             |
|                        |                                                                                                                                                  |                        |              |             |
|                        |                                                                                                                                                  |                        |              |             |
|                        |                                                                                                                                                  |                        |              |             |
|                        |                                                                                                                                                  |                        |              |             |
| Kood                   | Materjal                                                                                                                                         | File Charlie40 ISO.dwg | Leht 2/2     |             |

H = 1.500 m  
 TOTAL: 13.59 m<sup>2</sup>

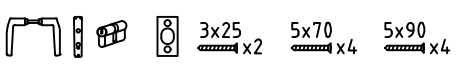
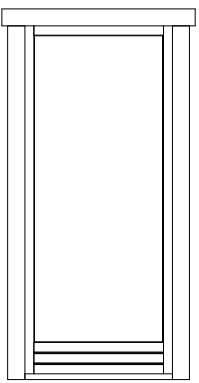
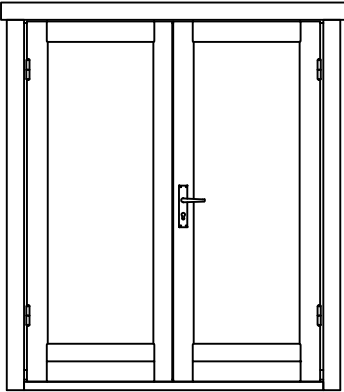
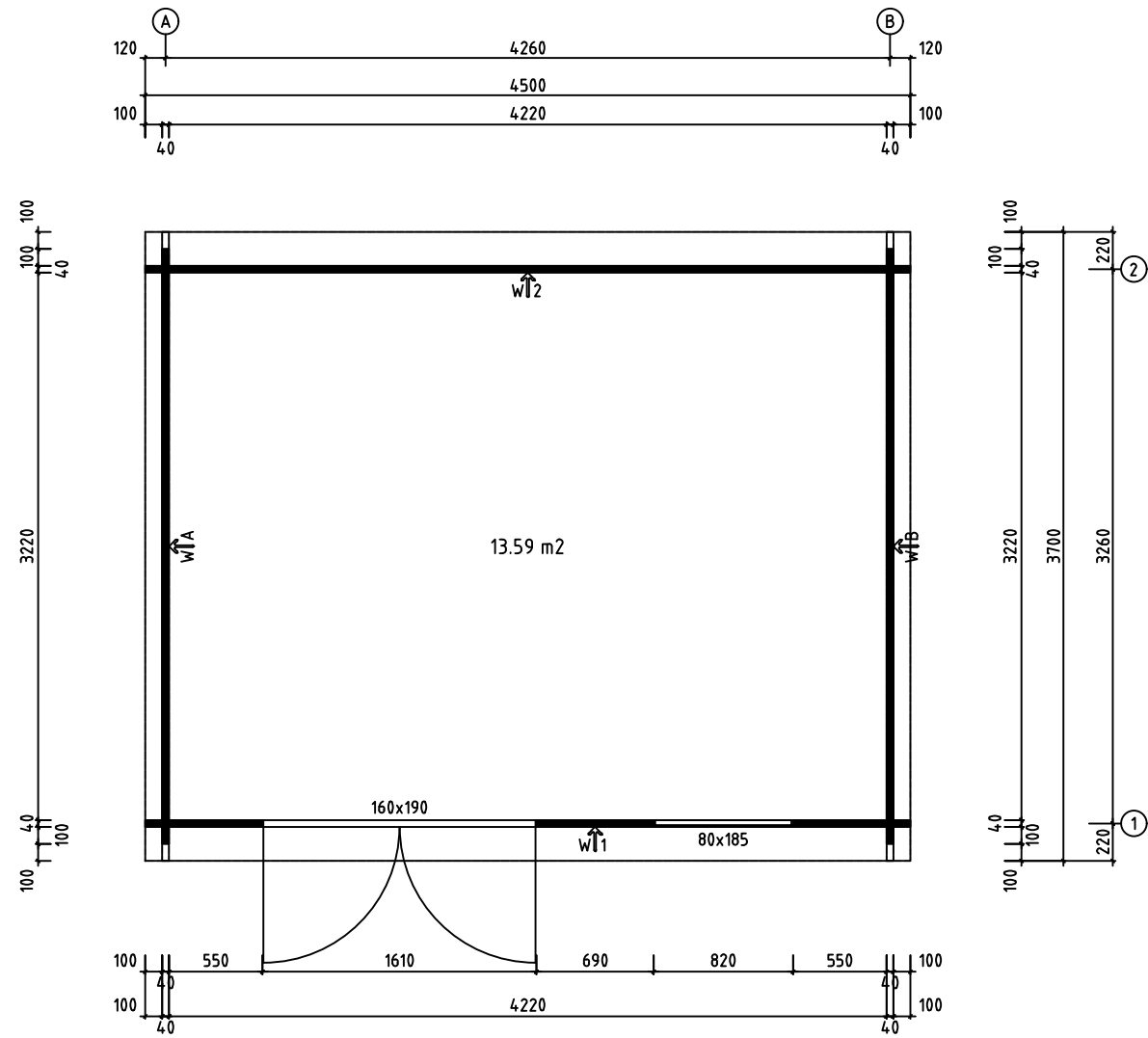

|          |               |       |                   |
|----------|---------------|-------|-------------------|
| Model    | Charlie40 ISO | Page  | PLAN              |
| Client   |               | Scale | 1:30              |
| Material | 40x114        | Date  | 25.12.2019        |
| Company  |               | File  | Charlie40 ISO.dwg |

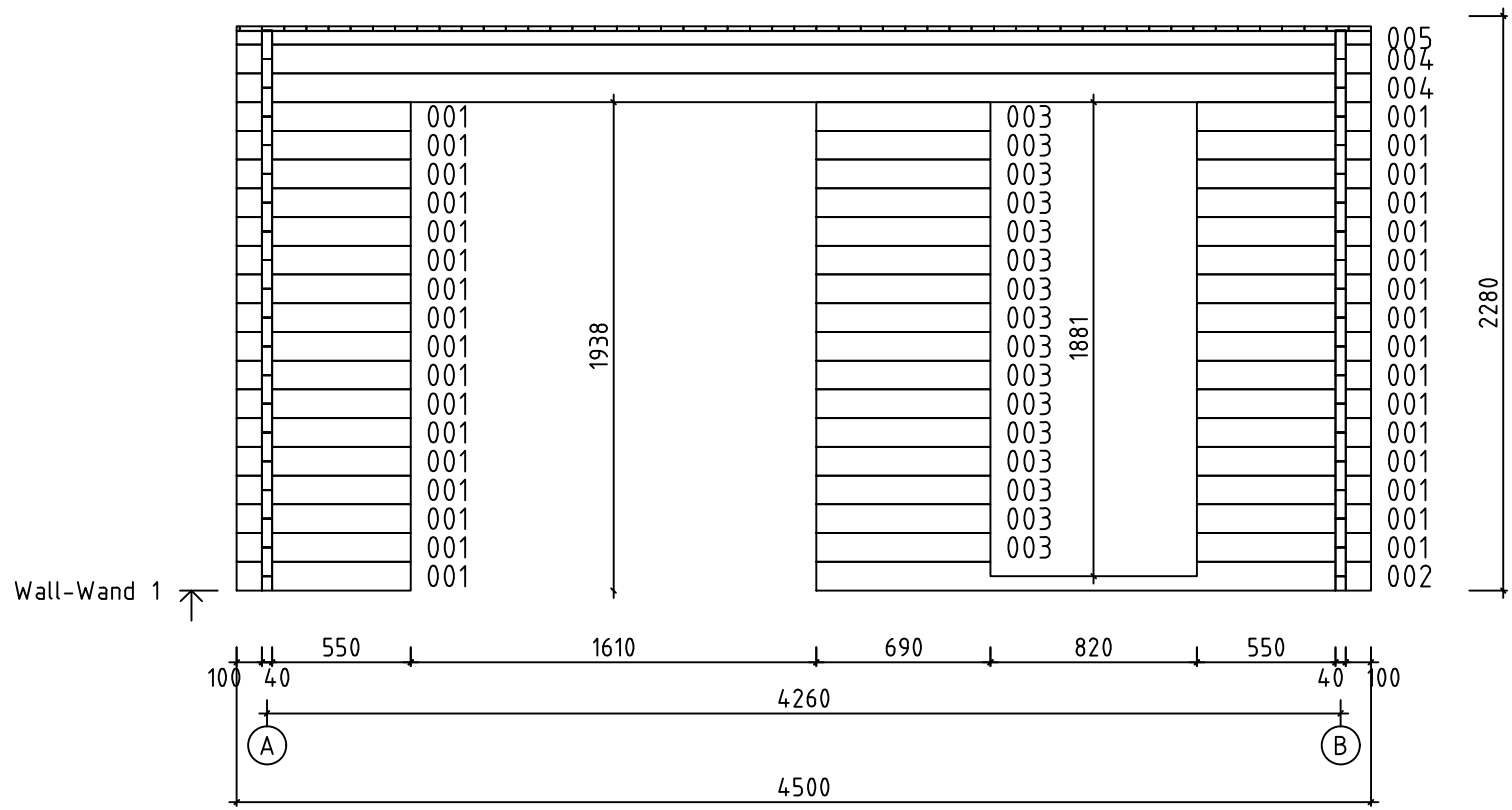

|          |               |       |                   |
|----------|---------------|-------|-------------------|
| Model    | Charlie40 ISO | Page  | 4                 |
| Client   |               | Scale | 1:30              |
| Material | 4x11.4        | Date  | 25.12.2019        |
| Company  |               | File  | Charlie40 ISO.dwg |

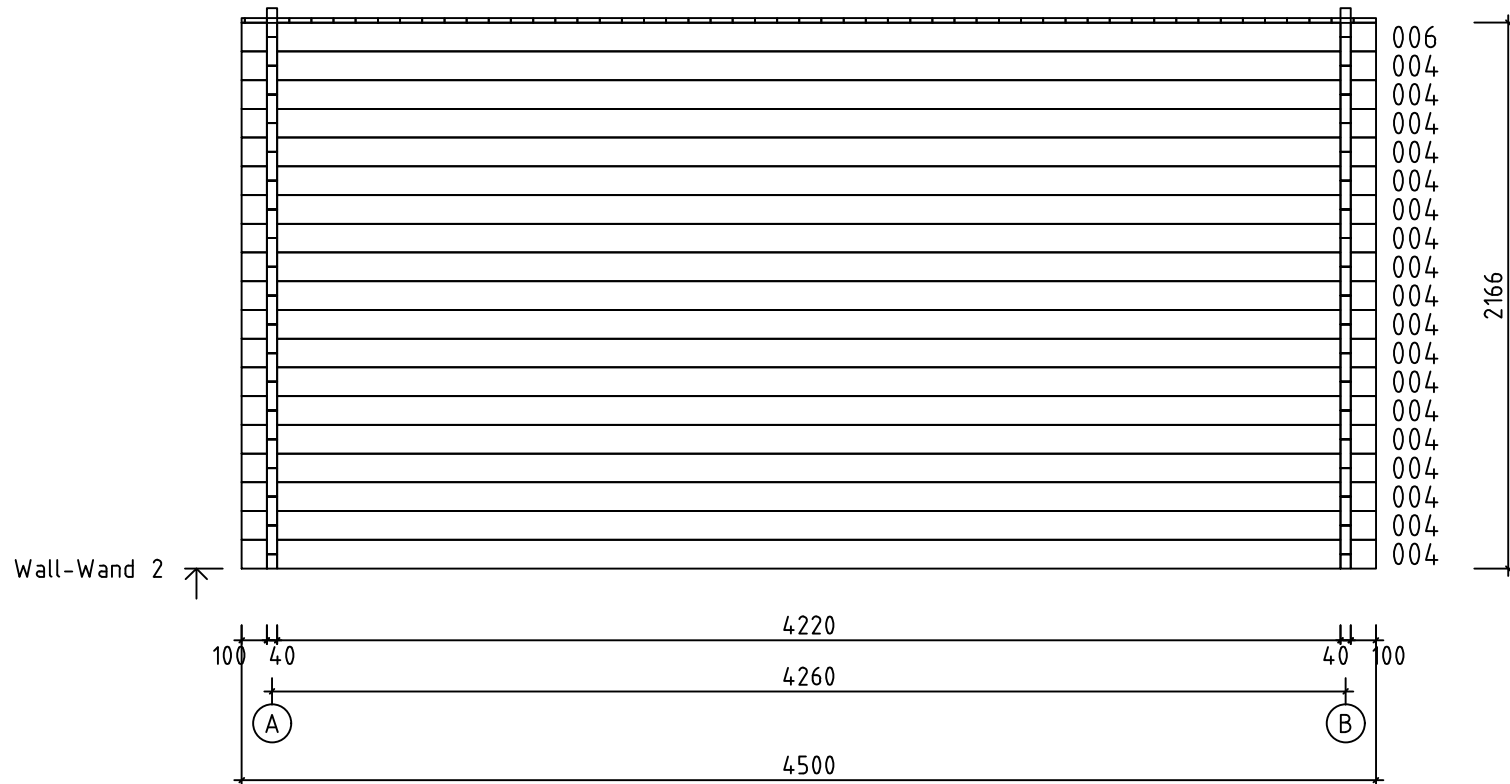

|                     |  |                        |
|---------------------|--|------------------------|
| Model Charlie40 ISO |  | Page 5                 |
| Client              |  | Scale 1:30             |
| Material 4x11.4     |  | Date 25.12.2019        |
| Company             |  | File Charlie40 ISO.dwg |

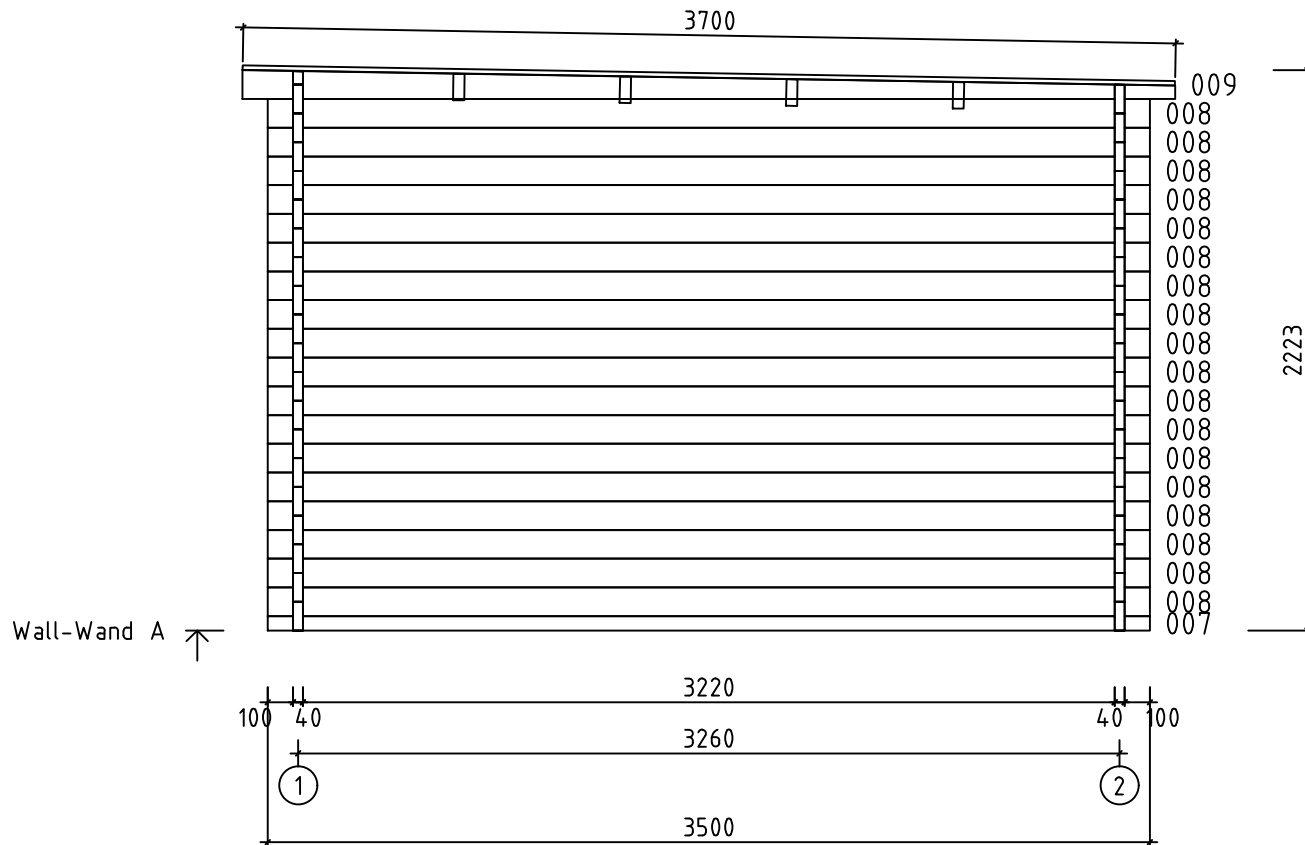

|          |               |       |                   |
|----------|---------------|-------|-------------------|
| Model    | Charlie40 ISO | Page  | 2                 |
| Client   |               | Scale | 1:30              |
| Material | 4x11.4        | Date  | 25.12.2019        |
| Company  |               | File  | Charlie40 ISO.dwg |

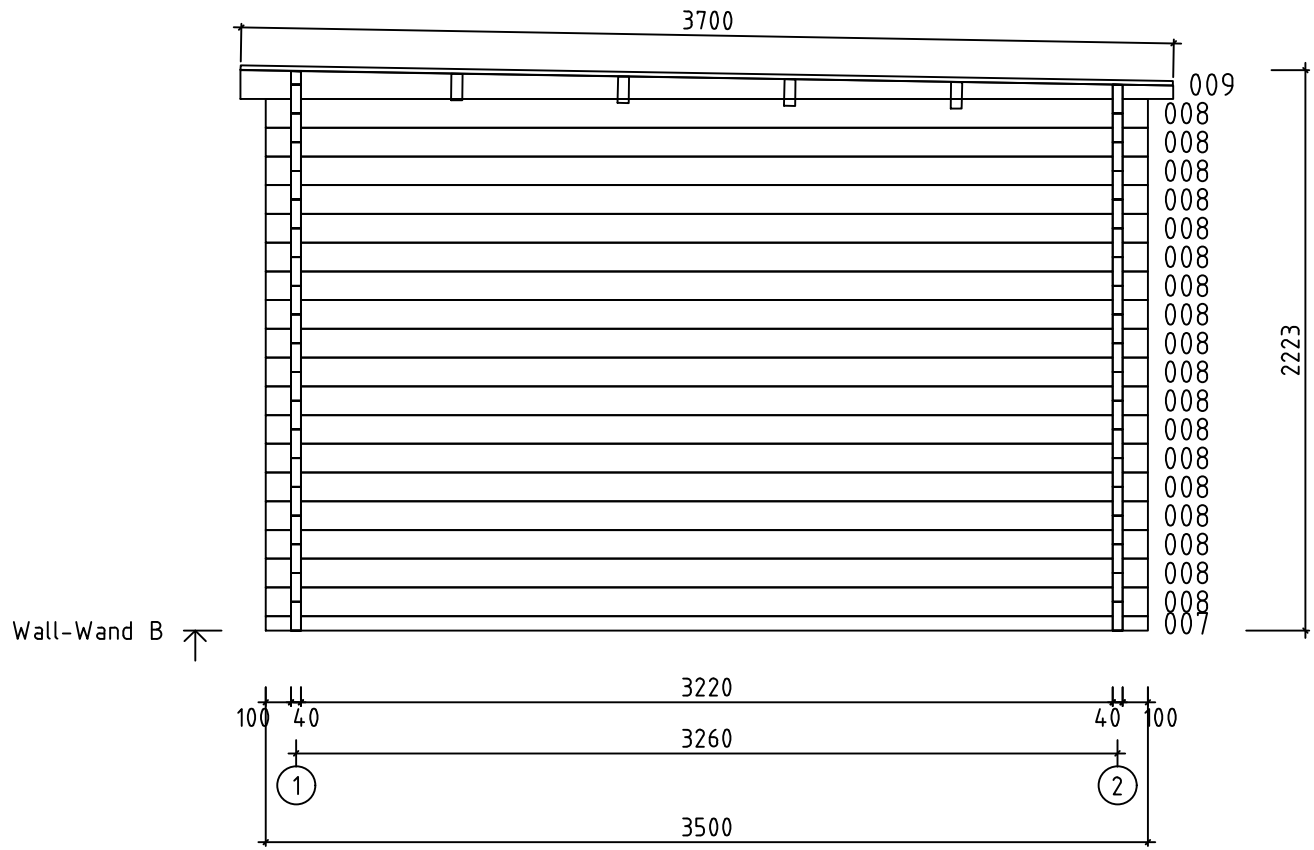

|          |               |       |                   |
|----------|---------------|-------|-------------------|
| Model    | Charlie40 ISO | Page  | 3                 |
| Client   |               | Scale | 1:30              |
| Material | 4x11.4        | Date  | 25.12.2019        |
| Company  |               | File  | Charlie40 ISO.dwg |



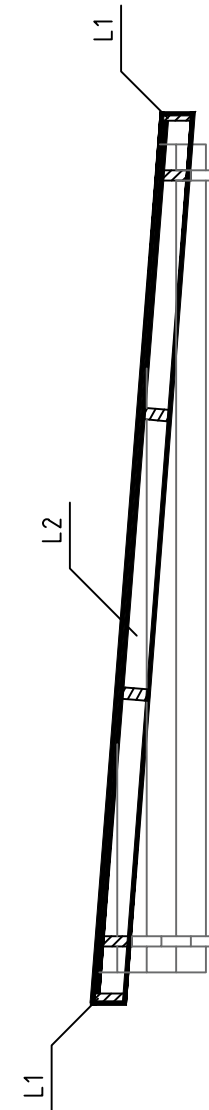

|          |               |       |                   |
|----------|---------------|-------|-------------------|
| Model    | Charlie40 ISO | Page  | ROOF              |
| Client   |               | Scale | 1:30              |
| Material | 40x114        | Date  | 25.12.2019        |
| Company  |               | File  | Charlie40 ISO.dwg |

The guide is illustrative. This guide is not project specification.  
 Der Leitfaden ist illustrativ. Dieser Leitfaden ist keine Projektspezifikation.  
 De gids is illustratief. Deze gids is geen projectspecificatie.

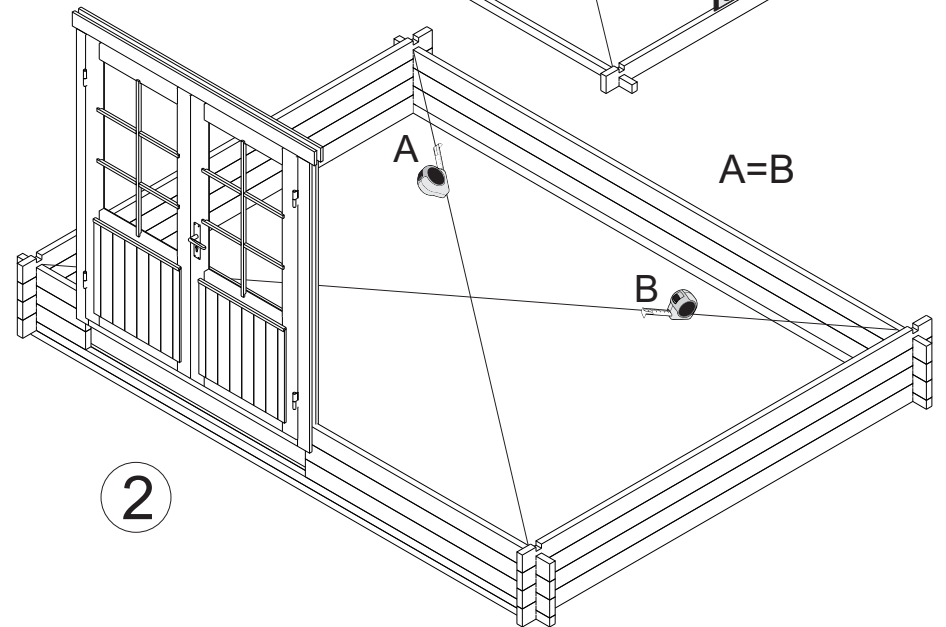
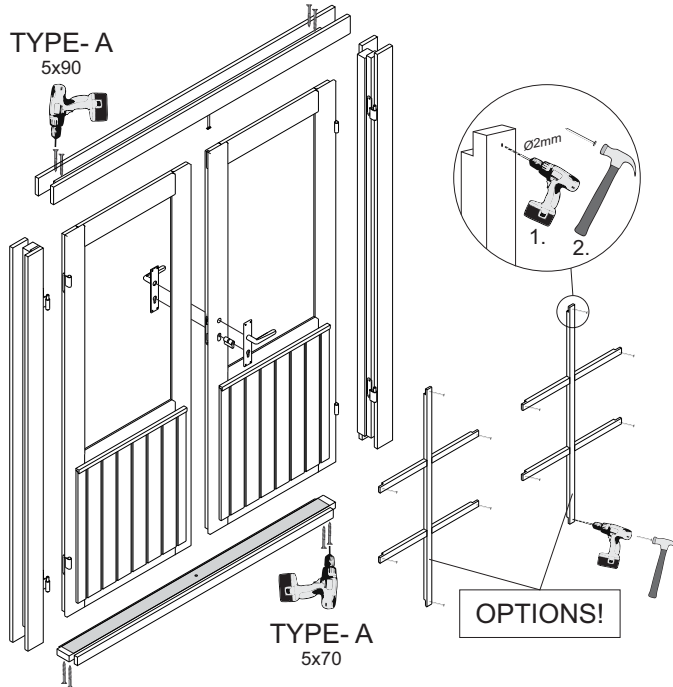
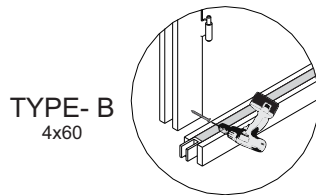
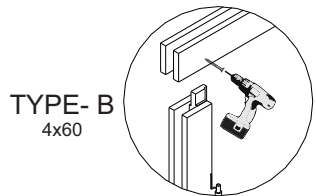
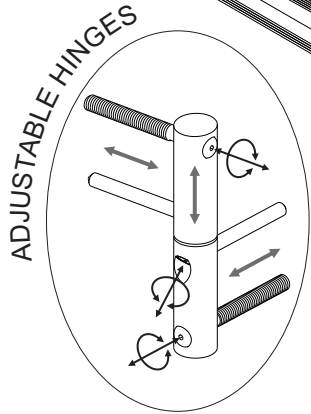
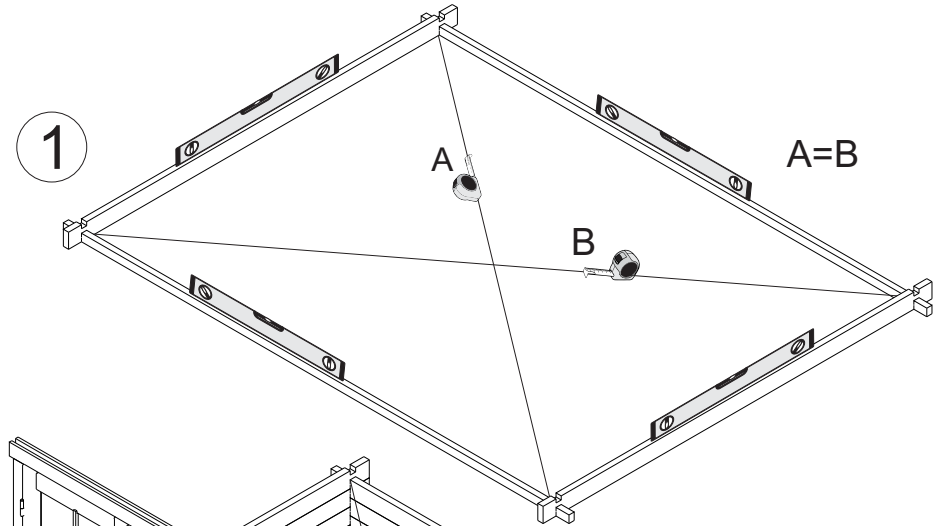
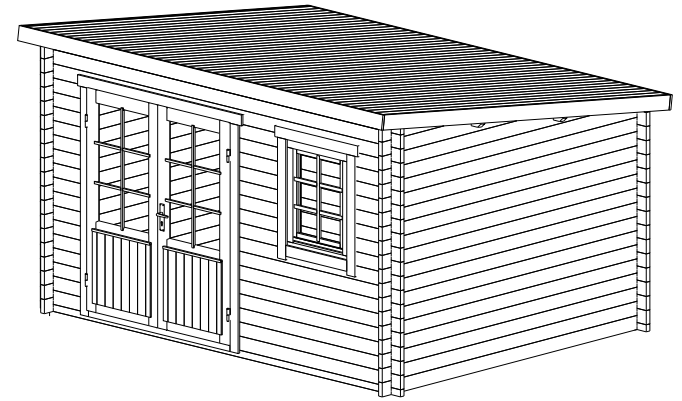
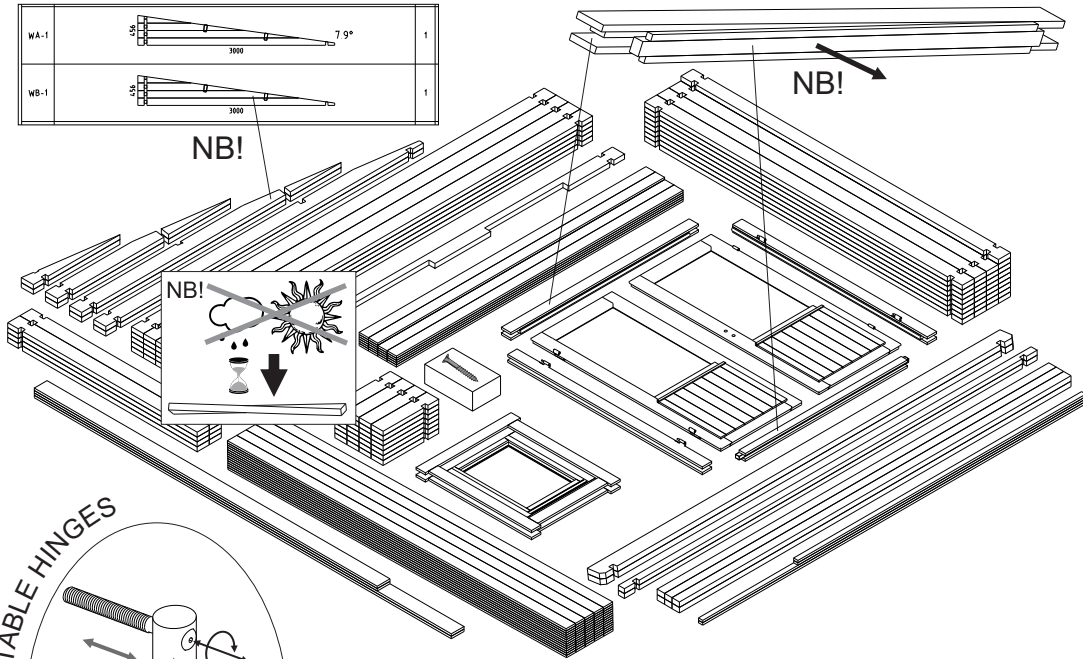
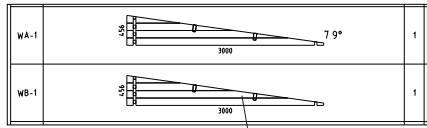

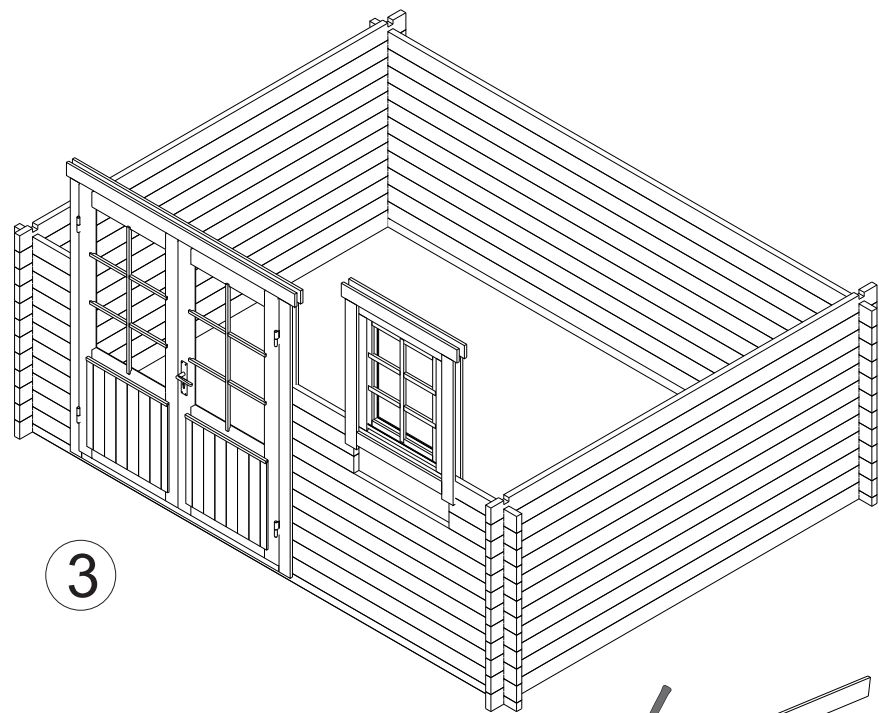

4

