

*Alex*  
*Art. Nr. 4414440*  
*1/8*

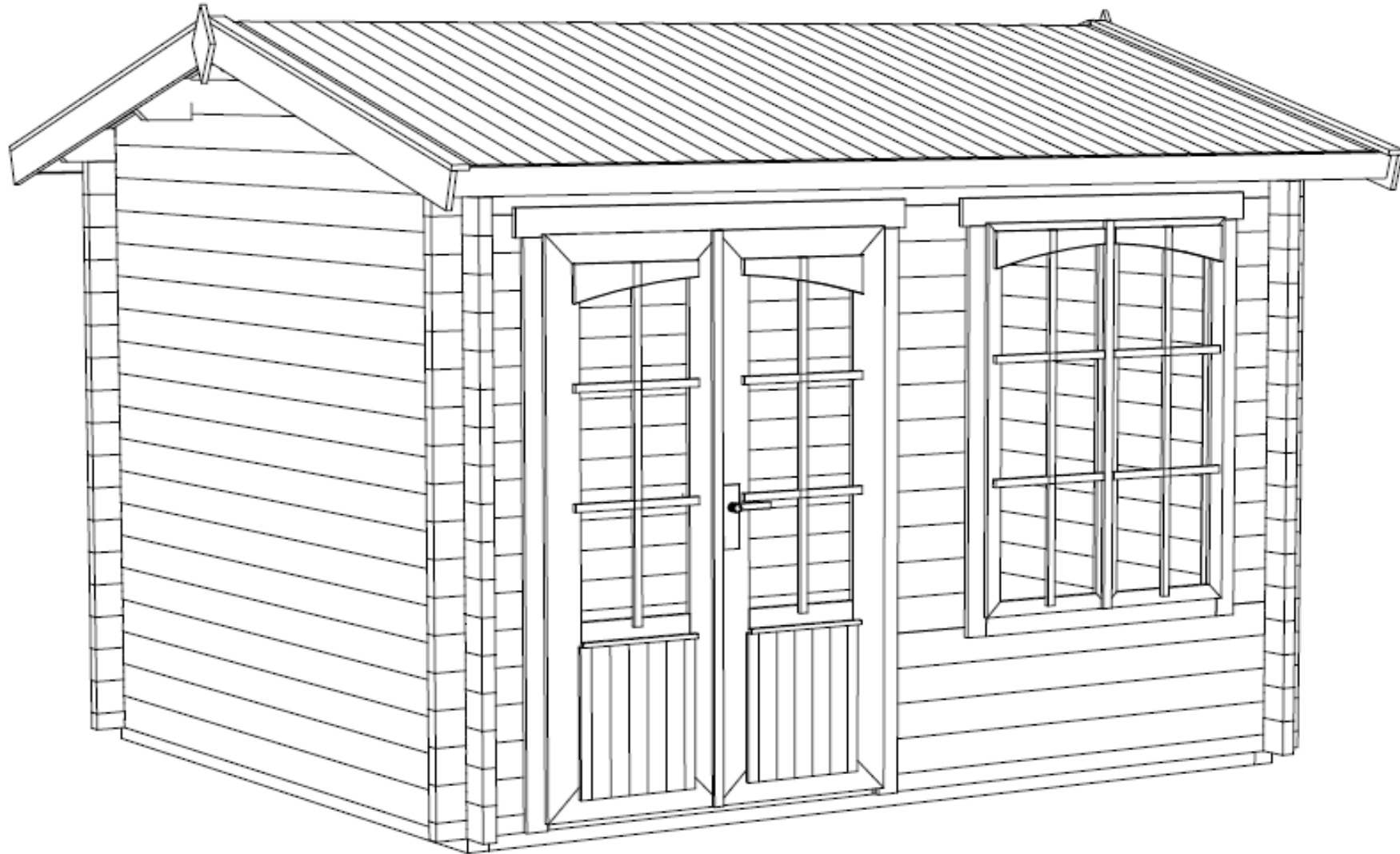

10.09.2013

Art.Nr. 4414440

GROUNDPLAN - GRUNDPLAN - PLAN DE MASSE

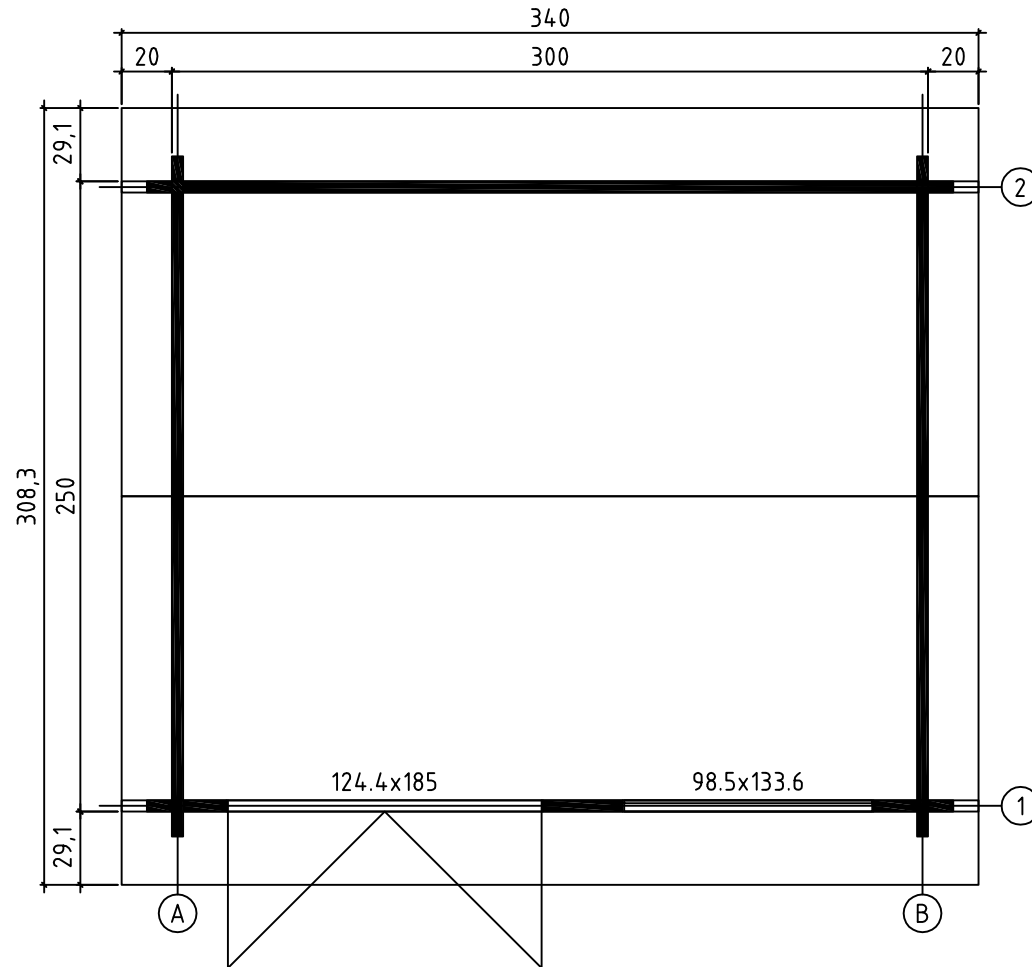

Art.Nr. 4414440

FOUNDATION - FUNDAMENT - FONDATION

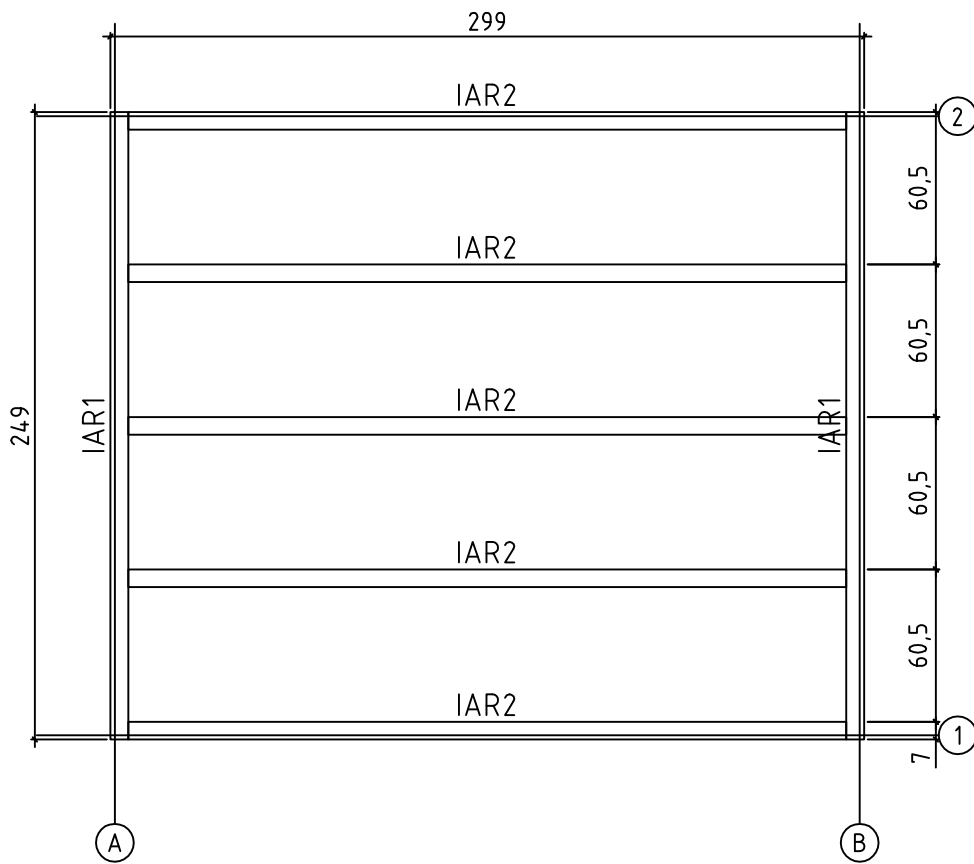

FLOOR BOARDS - FUSSBODENBRETTER - PLAN POSE PLANCHER

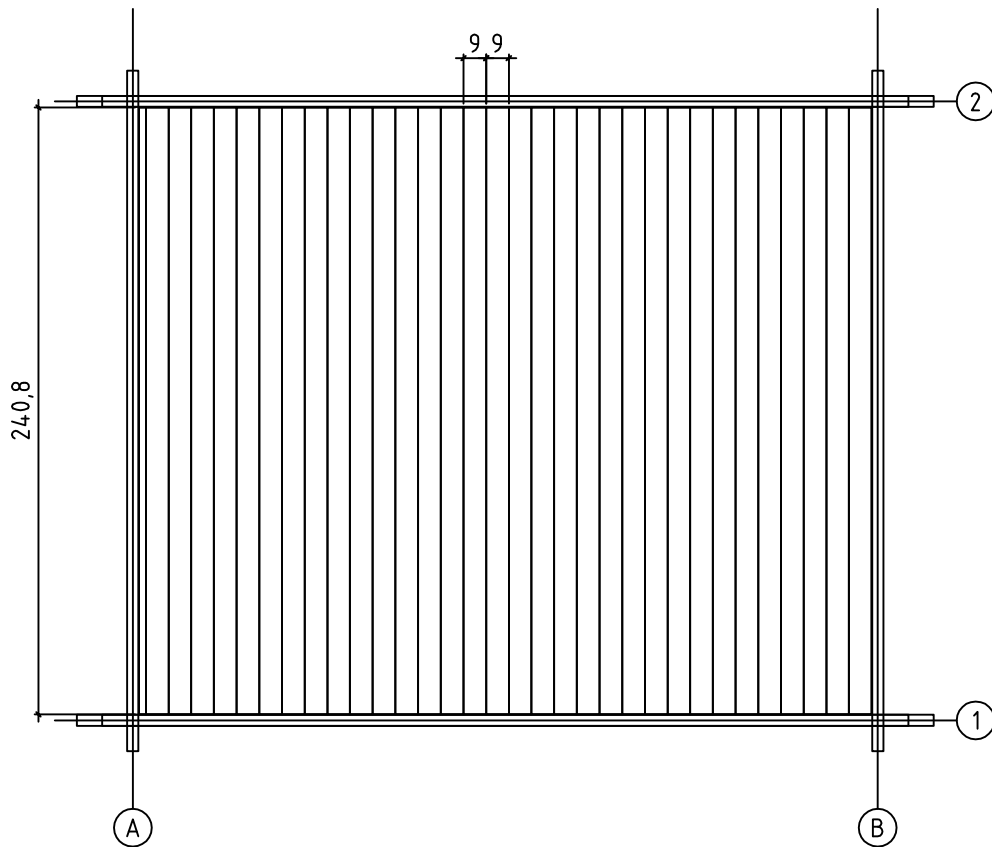



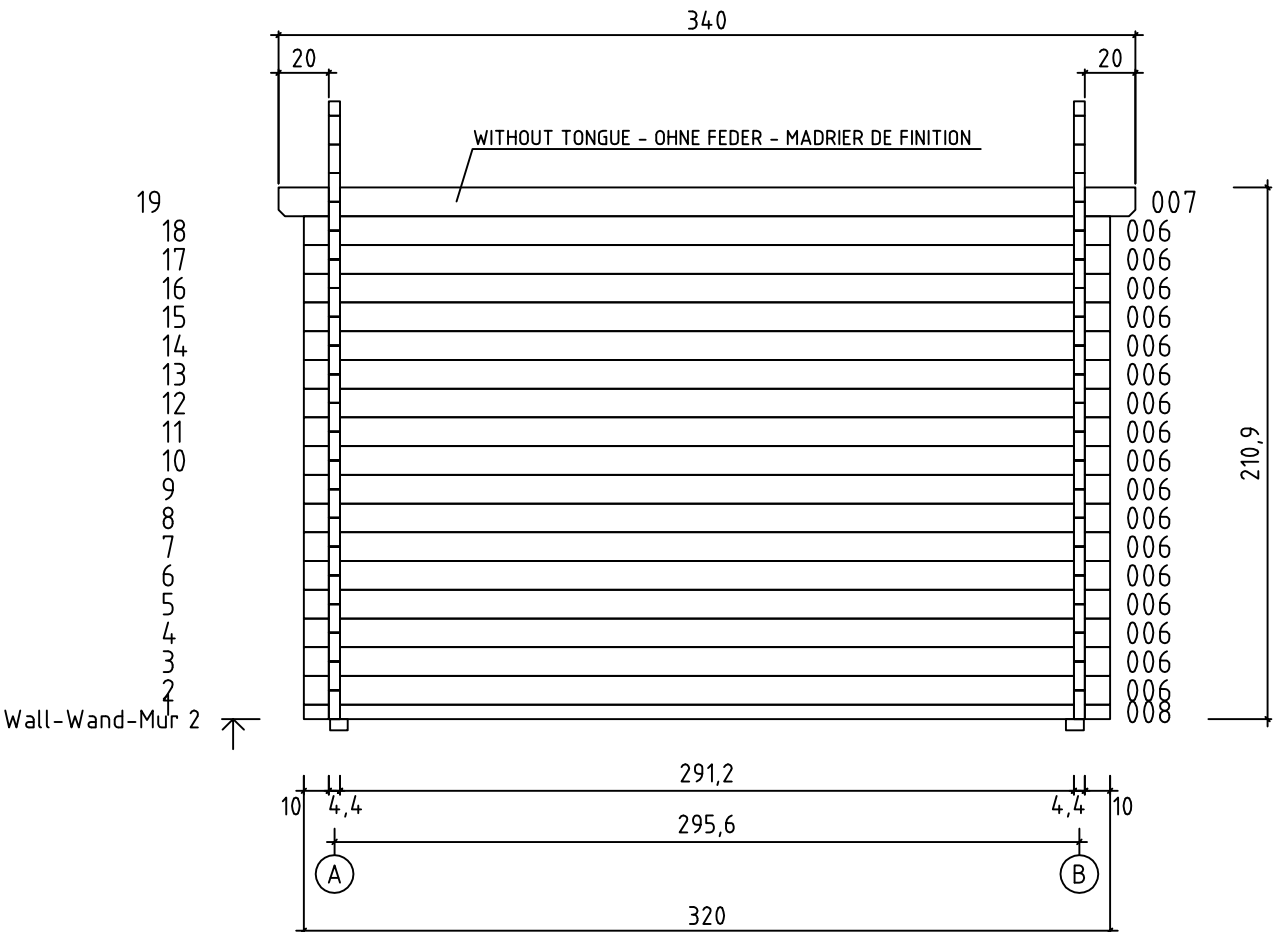
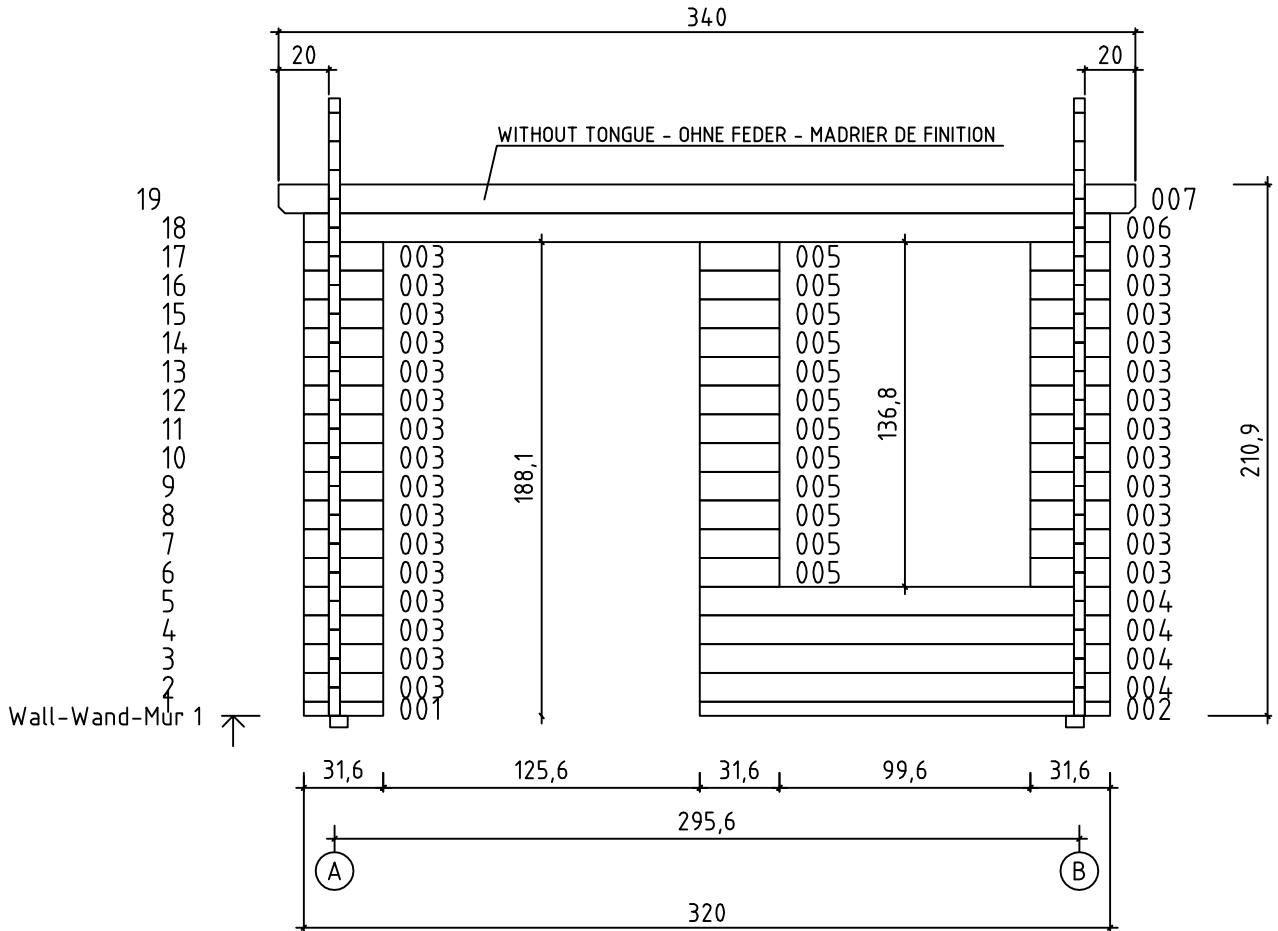



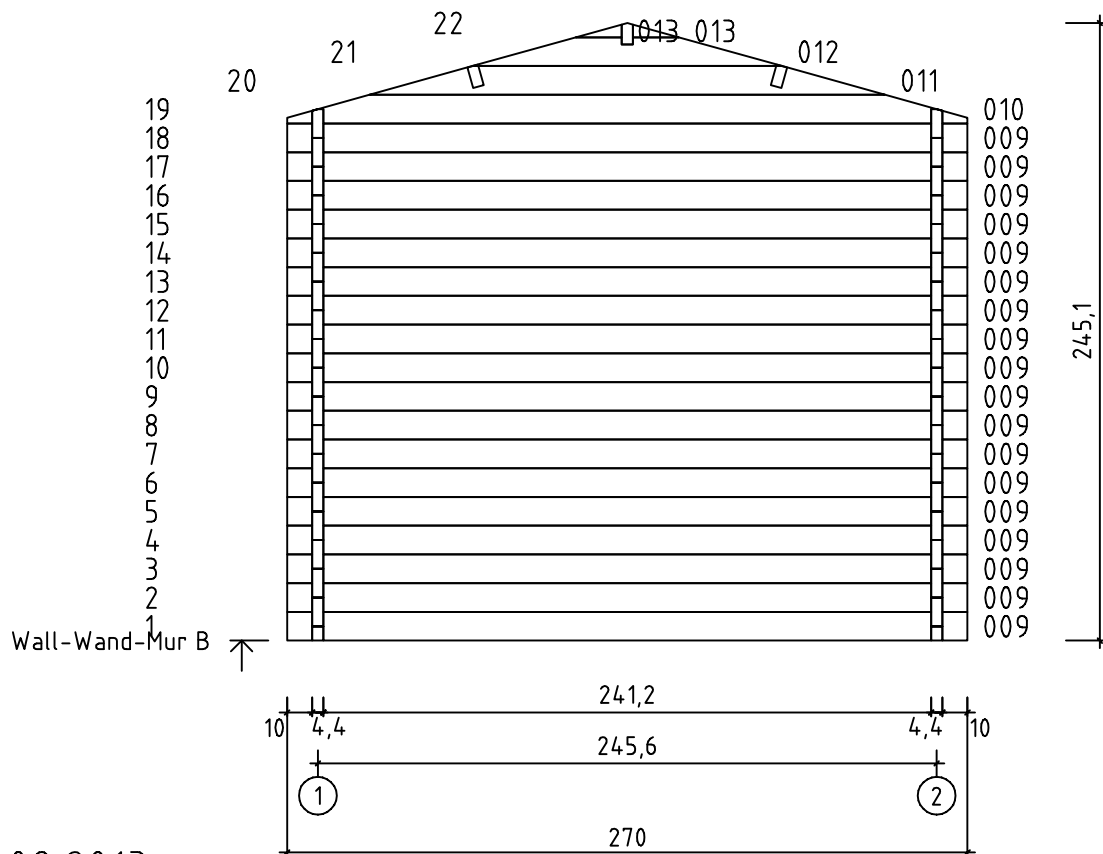
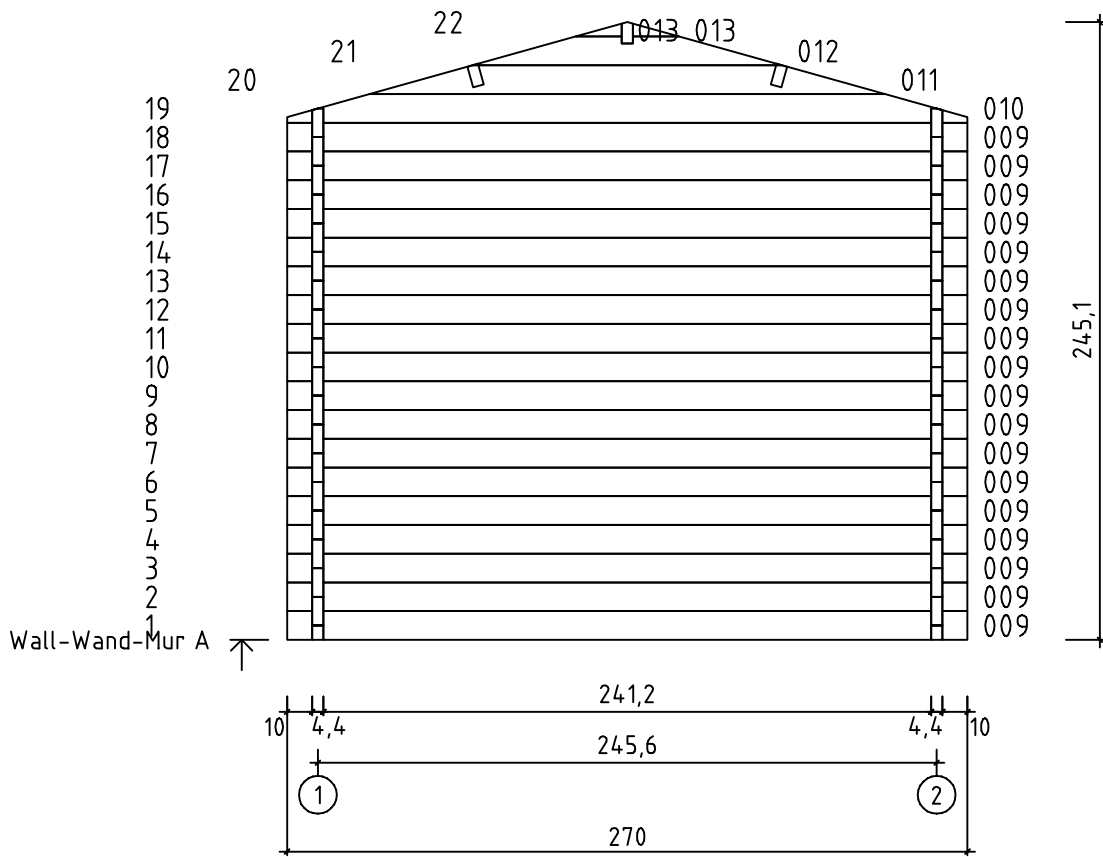

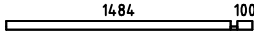

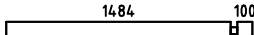

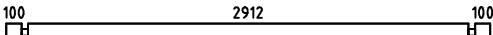
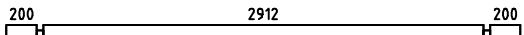
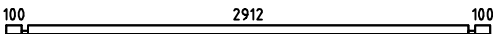
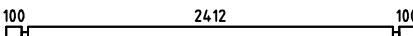
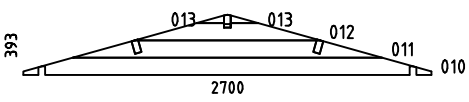
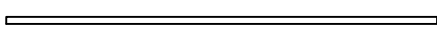
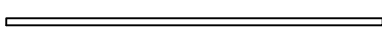
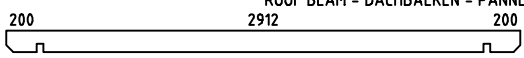
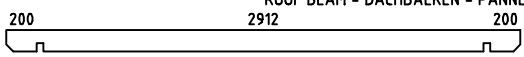



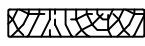

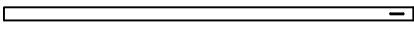
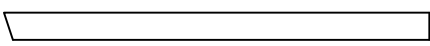
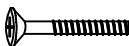



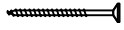
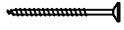
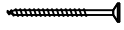
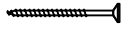

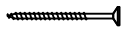

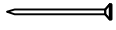
Art.Nr. 4414440

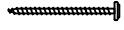

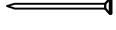
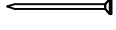
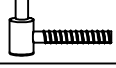
Art.Nr. 4414440

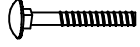

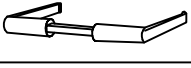
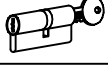
Pos	10.09.2013	Piecelist - Stücklist - Liste des composants Art.Nr. 4414440	6/8	Q.	P. (mm)	L. (mm)
001				1	44x57	316
002				1	44x57	1628
003				28	44x114	316
004				4	44x114	1628
005				12	44x114	316
006				18	44x114	3200
007				2	44x120	3400
008				1	44x57	3200
009				36	44x114	2700
WA-1 WB-1				1 1		
IAR2		FOUNDATION - FUNDAMENT - FONDATION		5	70x45	2850
IAR1		FOUNDATION - FUNDAMENT - FONDATION		2	70x45	2490
PR1		ROOF BEAM - DACHBALKEN - PANNE DE TOIT		1	44x140	3400
A-PR1		ROOF BEAM - DACHBALKEN - PANNE DE TOIT		2	44x140	3400
	FLOOR BOARDS - FUSSBODENBRETT - LAME DE PLANCHER			33	90x18	2408
	ROOF BOARDS - DACHBRETT - VOLIGES			76	90x18	1600
	FLOOR FILLET-FUSSBODENLEISTE - CORNIERE DE FINITION DU PLANCHER				18x18	10.63
	ROOFING FELT FILLET - DACHPAPPENLEISTE - BAGUETTE DE FIXATION DU FEUTRE BITUMEUX			4	18x58	1650
	EAVES BOARD - TRAUFBRETT - BANDEAU DE TOIT			2	18x90	3400
	ROOF EDGE REINFORCEMENT - DACHRANDVERSTÄRKUNG - CORNIERE DE RENFORT DE BORD DE TOIT			2	28x34	3400
	STORM PROTECTION - STURMLEISTE - - LATTE ANTI-TEMPETE			4	22x45	2050
	GABLE MOULDING - GIBELLEISTE - - PLANCHE DE RIVE			4	18x120	1650
	BOLT FOR WINDOW HANDLE FITTINGS - BOLZEN FÜR FENSTERGRIFF BESCHLAG - BOULON POUR POIGNÉE D'OUVERTURE DE FENETRE			4		
	SCREW FOR ROOF BEAMS - SCHRAUBEN FÜR DACHBALKEN - VIS POUR PANNE DE TOIT			10	5x120	

Pos	10.09.2013	Piecelist - Stücklist - Liste des composants Art.Nr. 4414440	7/8	Q.	P. (mm)	L. (mm)
		SCREW FOR 1. WALL BEAM - SCHRAUBE FÜR 1. BOHLENREIHE - VIS DE FIXATION DES FONDATIONS		6	5x90	
		SCREW FOR DOOR JAMB - SCHRAUBE FÜR TÜRRAHMEN - VIS DE FIXATION POUR MONTANT DE PORTE		4	5x90	
		SCREW FOR GABLE SEGMENT - SCHRAUBEN FÜR DECKBLATT - VIS POUR FIXATION LOSANGE DE FINITION		4	3.5x50	
		SCREW FOR GABLE MOULDING - SCHRAUBEN FÜR GIEBELLEISTE - VIS DE FIXATION POUR PLANCHE DE RIVE		24	3.5x50	
		SCREW FOR DOOR FILLET - SCHRAUBE ZUR BEFESTIGUNG TÜRLEISTE - VIS D'ASSEMBLAGE DU CADRE DE PORTE		5	3x30	
		SCREW FOR EAVES BOARDS - SCHRAUBEN FÜR TRAUFBRETTER - VIS DE FIXATION POUR BANDEAU DE TOIT		16	4x40	
		SCREW FOR FUNDAMENT - SCHRAUBEN ZUR BEFESTIGUNG FUNDAMENT - VIS POUR FONDATION		10	5x120	
		WINDOW HANDLE FITTINGS - FENSTERGRIFF - POIGNÉE D'OUVERTURE DE FENETRE		2		
		ZN NAIL FOR FLOOR FILLET - ZN NÄGEL FÜR FUSSBODENLEISTE - POINTE POUR CORNIERE DE FINITION DU PLANCHER		21	1.4x40	
		SET OF DOOR LOCK COVERS - SCHLOSSBLENDEN - SET DE GARNITURES DE SERRURE DE PORTE		1		
		HAMMER BLOCK - SCHLAGHOLZ - CALLE DE FRAPPE		1		
		SCREW FOR DOORSTEP - SCHRAUBEN FÜR SWELLE - VIS DE FIXATION DU SEUIL DE PORTE		3	4.5x65	
		NUT FOR STORM PROTECTION - SCHRAUBENMUTTER FÜR STURMLEISTE - ÉCROU POUR LAME ANTI-TEMPETE		8		
		ZN NAIL FOR ROOF - ZN NÄGEL FÜR DACHBRETTER - POINTES DE FIXATIONS DES VOLIGES DE TOIT		242	2x50	
		ZN NAIL FOR FLOOR - ZN NÄGEL FÜR FUSSBODENBRETTER - CLOUS POUR PLANCHER		170	2x50	
		ZN NAIL FOR ROOFING FELT FILLET - ZN NÄGEL FÜR DACHPAPPENLEISTE - POINTE POUR BAGUETTE FIXATION FEUTRE BITUMEUX		16	2x40	
		MALE BOLT HINGE FOR DOOR - TÜRRIEGEL - PARTIE MALE DE CHARNIERE DE PORTE		6		
		SCREW FOR ROOF EDGE REINFORCEMENT - SCHRAUBEN FÜR DACHRANDVERSTÄRKUNG - VIS POUR RENFORT DE BORD DE TOIT		16	4x40	
		BOLT FOR STORM PROTECTION - BOLZEN FÜR STURMLEISTE - VIS POUR LAME ANTI-TEMPETE		8	8x80	
		GABLE SEGMENT - DECKBLATT - LOSANGE DE FINITION		2		
		WASHER FOR STORM PROTECTION - DICHTSCHEIBE FÜR STURMLEISTE - RONDELLE POUR LAME ANTI-TEMPETE		8		
		DOOR HANDLE FITTINGS - TÜRGRIFF - SET DE GARNITURES DE SERRURE DE PORTE		1		
		CYLINDER LOCK - ZYLINDERSCHLOSS - CYLINDRE DE SERRURE		1		
		SCREW FOR GEORGIAN BARS - SCHRAUBE FÜR SPROSSEN - VIS DE BARRES GEORGIENNE		36	2.5x20	

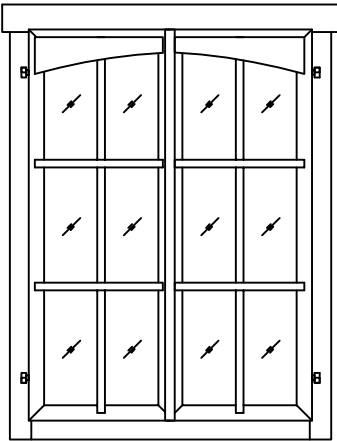
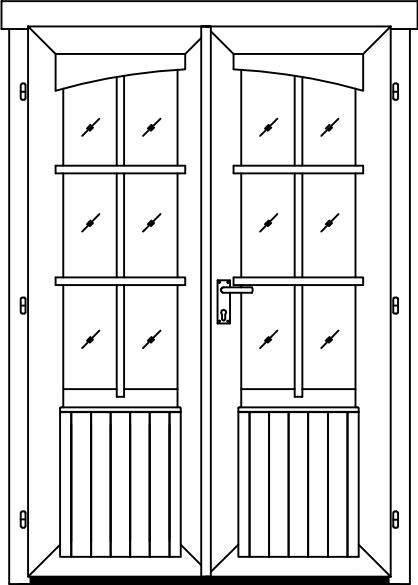
Pos	10.09.2013 Piecelist - Stücklist - Liste des composants Art.Nr. 4414440	8/8	Q.	P. (mm)	L. (mm)
	<p data-bbox="233 197 817 226">WINDOW - FENSTER - FENETRE 985x1336 DGC+UK</p> <p data-bbox="987 197 1189 226">TAK.1.106.PVP.Kf</p> 	1			
	<p data-bbox="233 750 711 779">DOOR - TÜR - PORTE 1244x1850 DGC+UK</p> <p data-bbox="919 750 1189 779">TUK.2.066.PVP.MMKWe</p> 	1			