

Art. Nr. 3416000

1/8

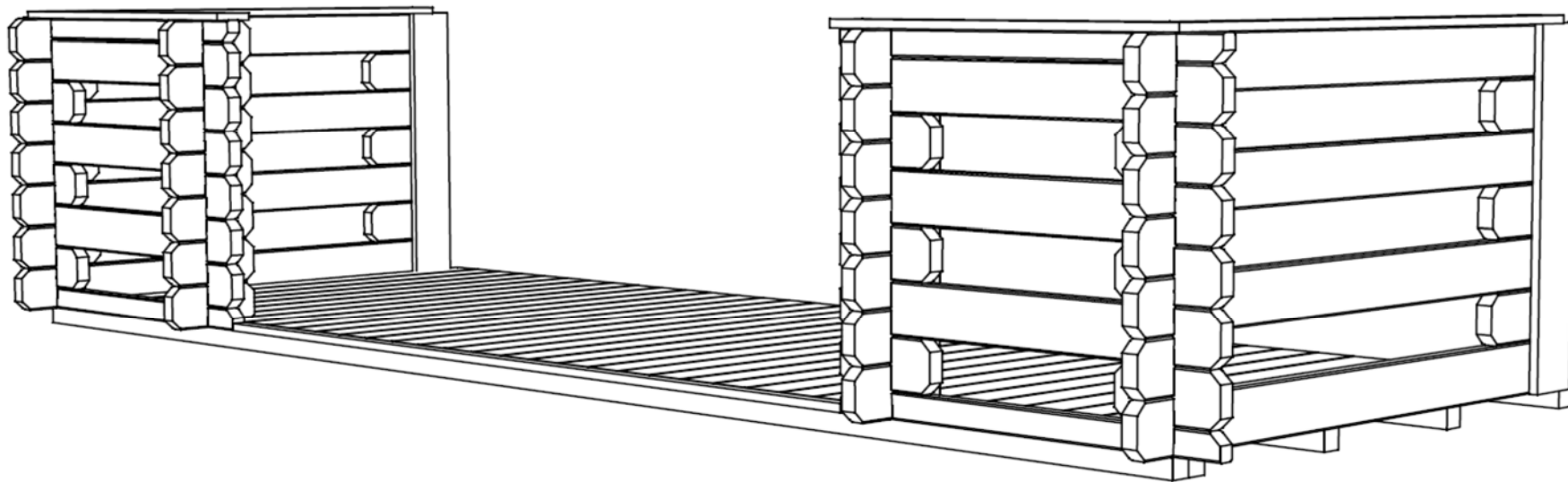

10.11.2017

Art.Nr 3416000

Groundplan - Grundplan - Plan de masse - Planimetria - Plattegrond -
Põhiplaan

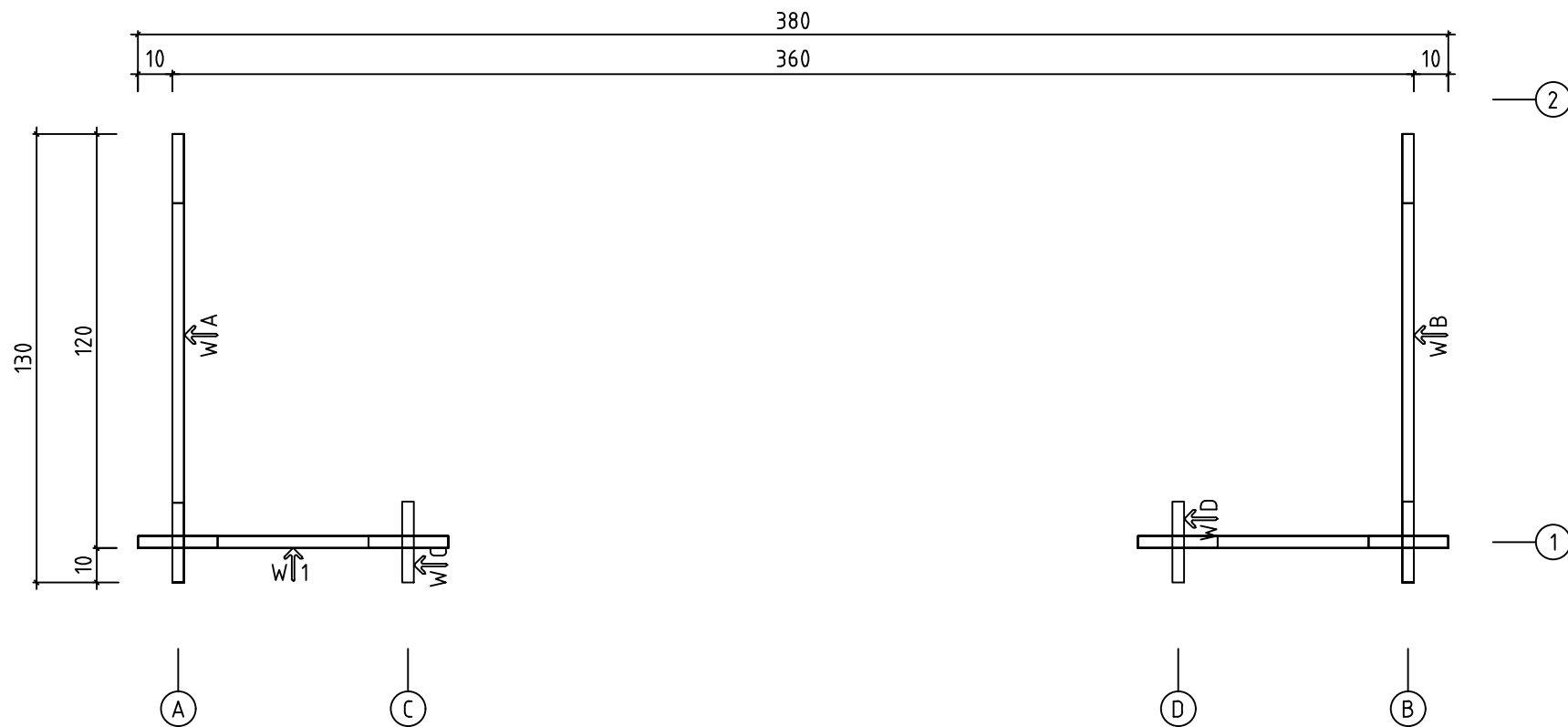

Art.Nr 3416000

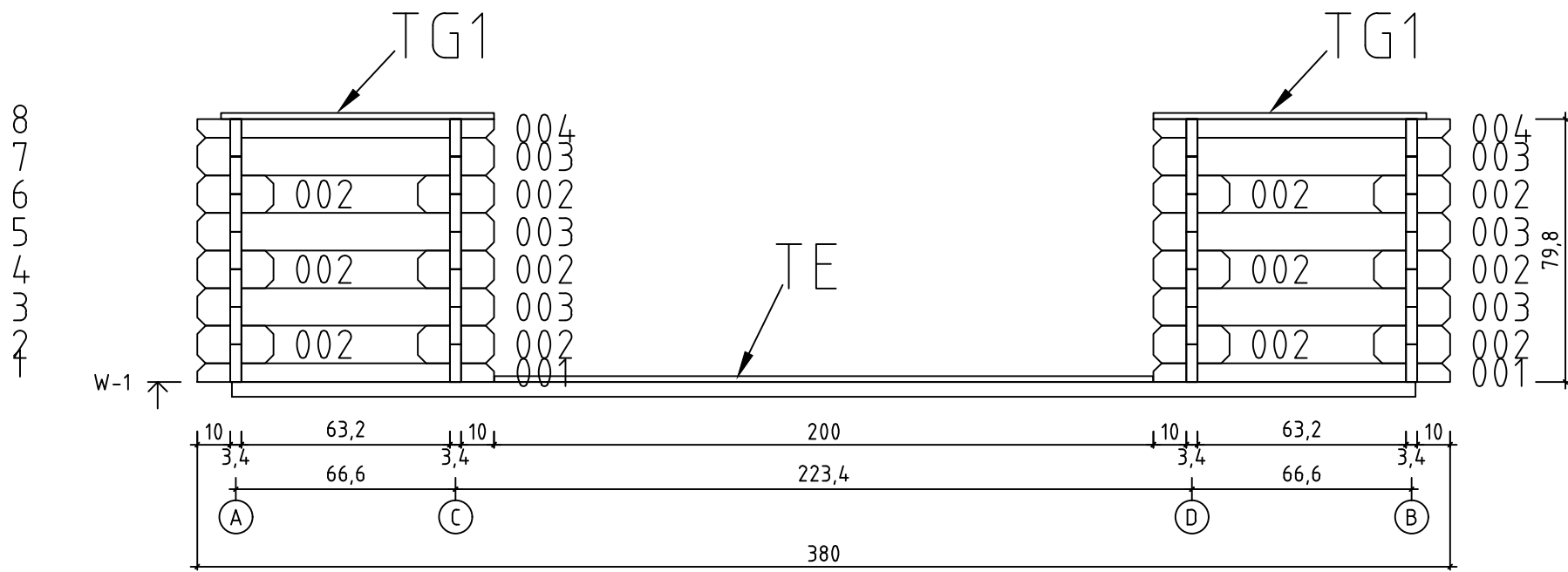

Art.Nr 3416000

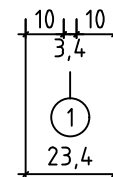
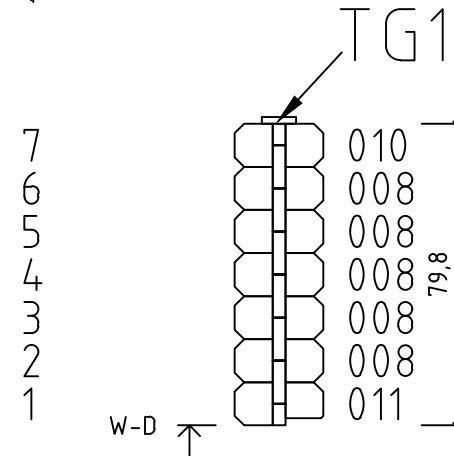
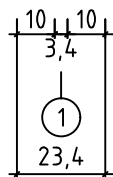
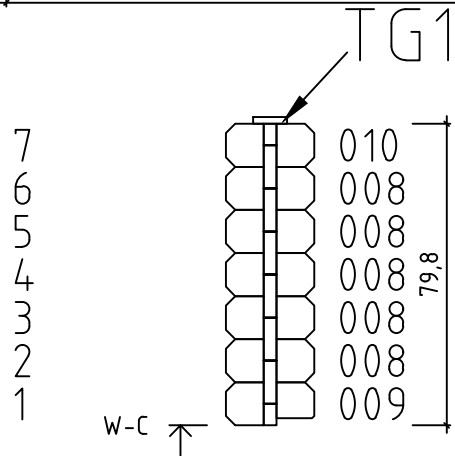
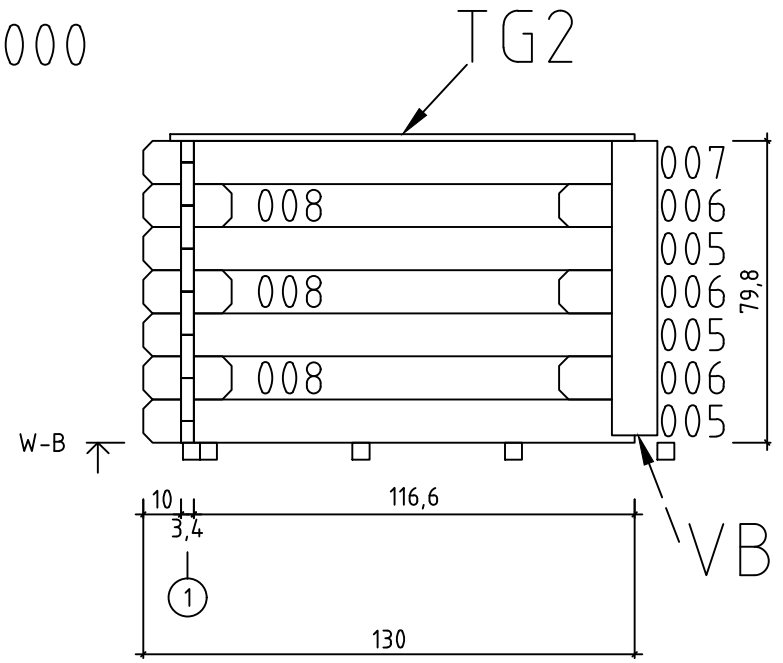
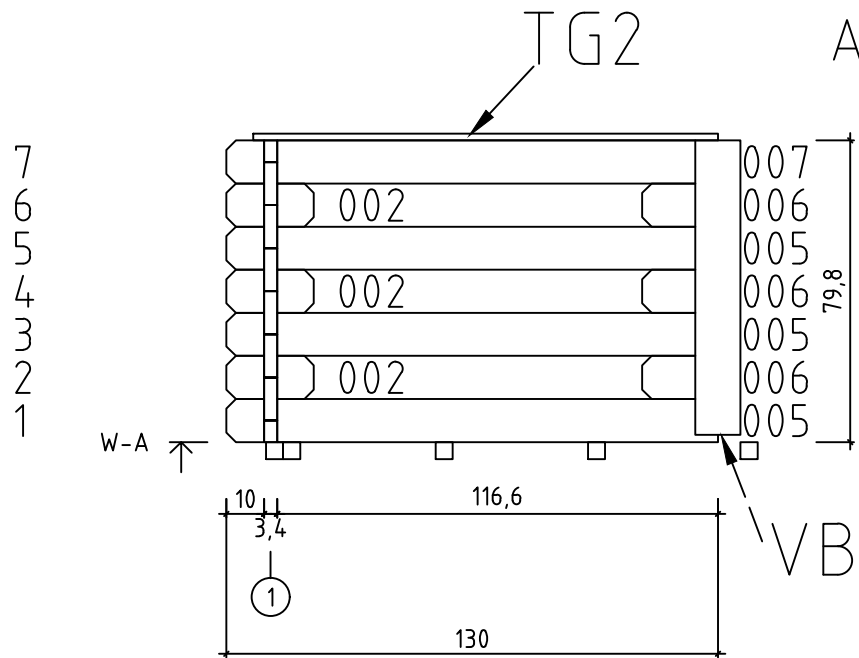

Art.Nr 3416000



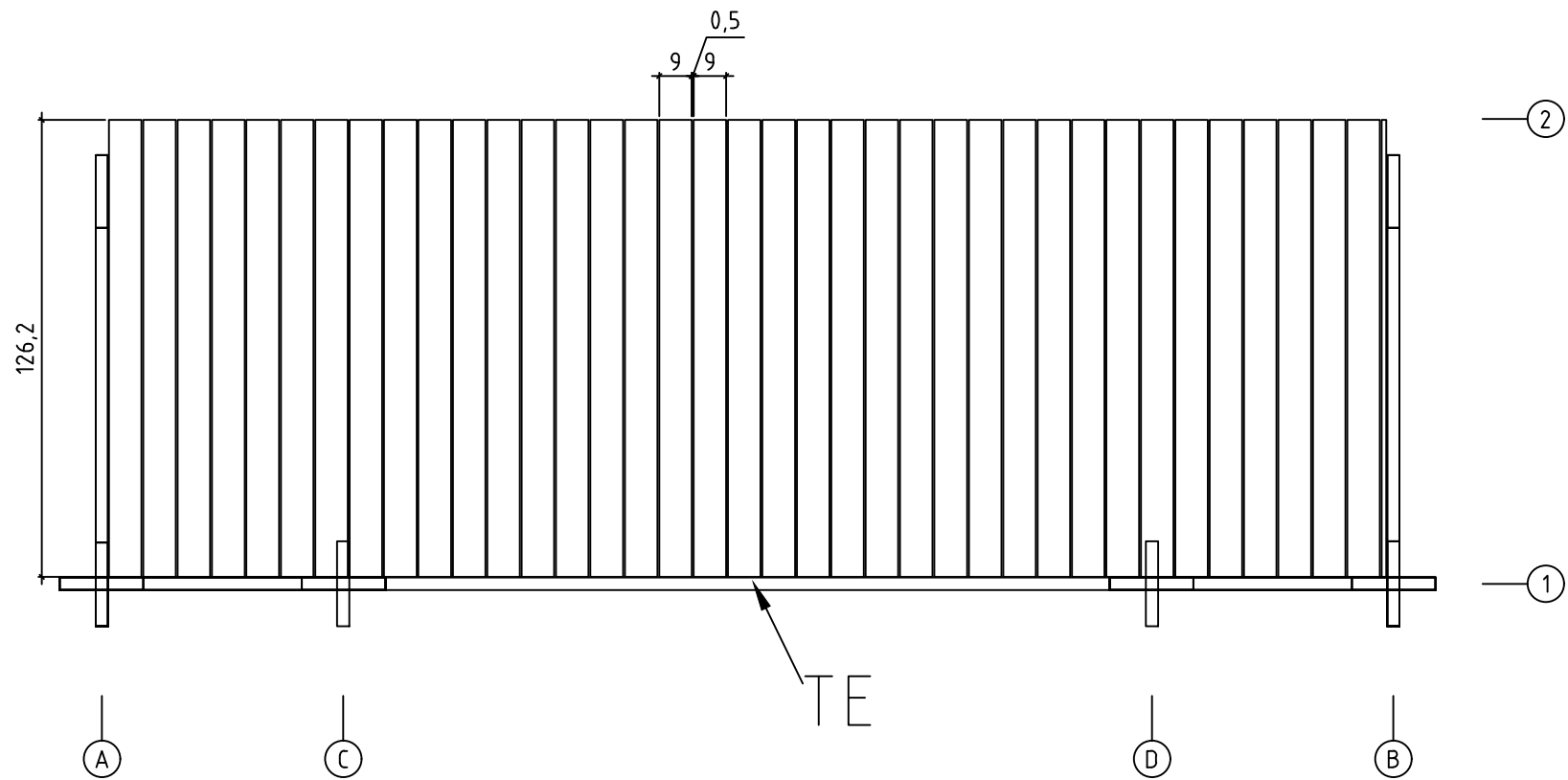





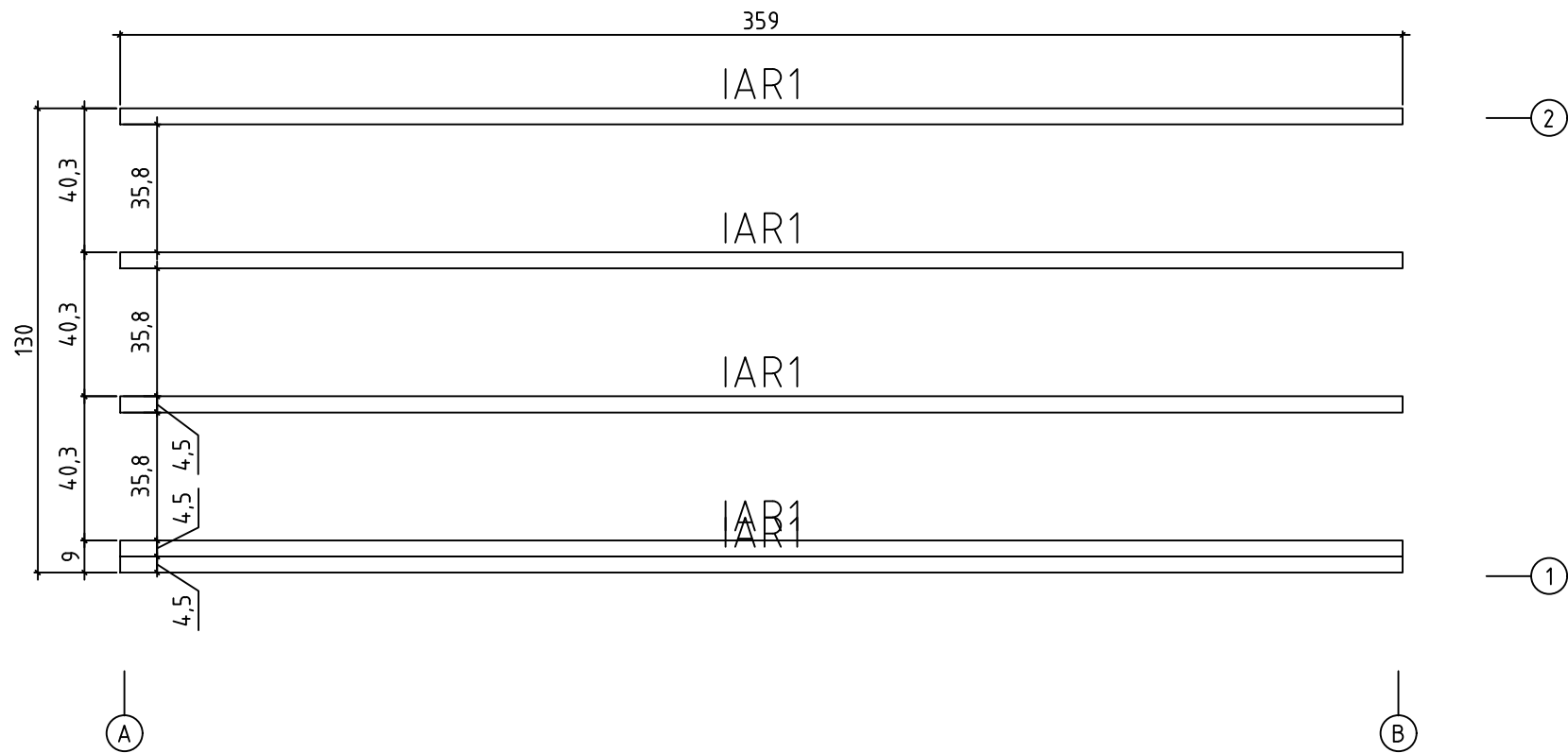

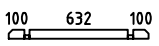

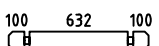
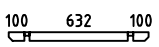
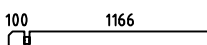

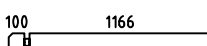



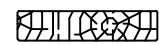

Terrace boards - Terrassenbretter - Plancher de terrasse - Piattaforme
terrazzo - Terrasvloer - Terrassilaud

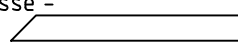
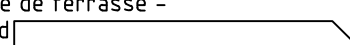

Art.Nr 3416000

Foundation - Fundament - Fondation - Fondamenta - Fundering - Immutatud
alusraam



Pos	Piece list - Stückliste - Liste des pièces - Elementi - Stuklijst - Tükítabel 10.11.2017 Art.Nr 3416000	7/8	Q	P (mm)	L (mm)
001			2	34x57	900
002	10097 		15	34x114	231
003			6	34x114	900
004			2	34x57	900
005			6	34x114	1300
006			6	34x114	200
007			2	34x114	1300
008	100100 		13	34x114	234
009	100100 		1	34x114	234
010	100100 		2	34x114	234
011	100100 		1	34x114	234
IAR1	Foundation - Fundament - Fondation - Fondamenta - Fundering - Immutatud alusraam 		5	45x45	3590
	Terrace boards - Terrassenbretter - Plancher de terrasse - Piattaforme terrazzo - Terrasvloer - Terrasilaud 		38	90x19	1262
TE	Terrace edge board - Terrassenbrett, eingang - Lamé de seuil d'entree de terrasse - Terrazzo uso abitacolo - Terrasvloer dorpel - Terrassi servaliist 		1	19x34	1998
TG1	Guard-rail for terrace - Terrassengeländer - Main courante de terrasse - Guardrail per terrazzo - Terras leuning - Terrassi äärelaud 		2	18x90	828
TG2	Guard-rail for terrace - Terrassengeländer - Main courante de terrasse - Guardrail per terrazzo - Terras leuning - Terrassi äärelaud 		2	18x90	1228
VB	Terrace joint boards - Verbindungsbrett - Profil de jonction pour fixer la terrasse au mur - Assi del terrazzo che compongono il pavimento - Terras verbindingsplank - Terrassi ühenduslaud 		4	18x120	779
HS9	Screw for terrace joint boards - Schrauben für Verbindungsbrett - Vis de fixation profil de jonction terrasse - Vite per unire delle assi del terrazzo - Schroef voor bevestigen verbindingshout - Kruvi terrassi ühenduseks seinaga 		20	3.5x50	
HS12	Screws for terrace edge board - Schrauben für Terrassenbrett - Vis de fixation de lamé de seuil d'entree de terrasse - Vite per unire delle assi del terrazzo - Schroeven voor terrashout - Kruvi terrassi servaliistule 		6	4x40	
HS12	Screw for terrace rear boards - Schrauben für Terrassenrand - Vis de fixation pour main courante de terrasse - Vite per il piano posteriore della terrazzo - Schroef voor terras afsluitplint (achterzijde) - Kruvi terrassi äärelauale 		14	4x40	
HS16	Screw for 1. wall beam - Schraube für 1. Bohlenreihe - Vis de fixations 1ere rangée de madriers avec poutrelles de fondations - Vite fissaggio alle fondamenta - Schroef voor 1 wandbalk - Kruvi poollauale 		6	5x90	
HS16	Screw for foundation - Schrauben zur Befestigung Fundament - Vis de fixations des poutrelles de fondations - Viti x fondamenta - Schroef voor fundering - Kruvi alusraamile 		3	5x90	
HS22	Screw for 1. wall beam - Schraube für 1. Bohlenreihe - Vis de fixations 1ere rangée de madriers avec poutrelles de fondations - Vite fissaggio alle fondamenta - Schroef voor 1 wandbalk - Kruvi poollauale 		4	6x150	

