

# ASSEMBLY INSTRUCTIONS

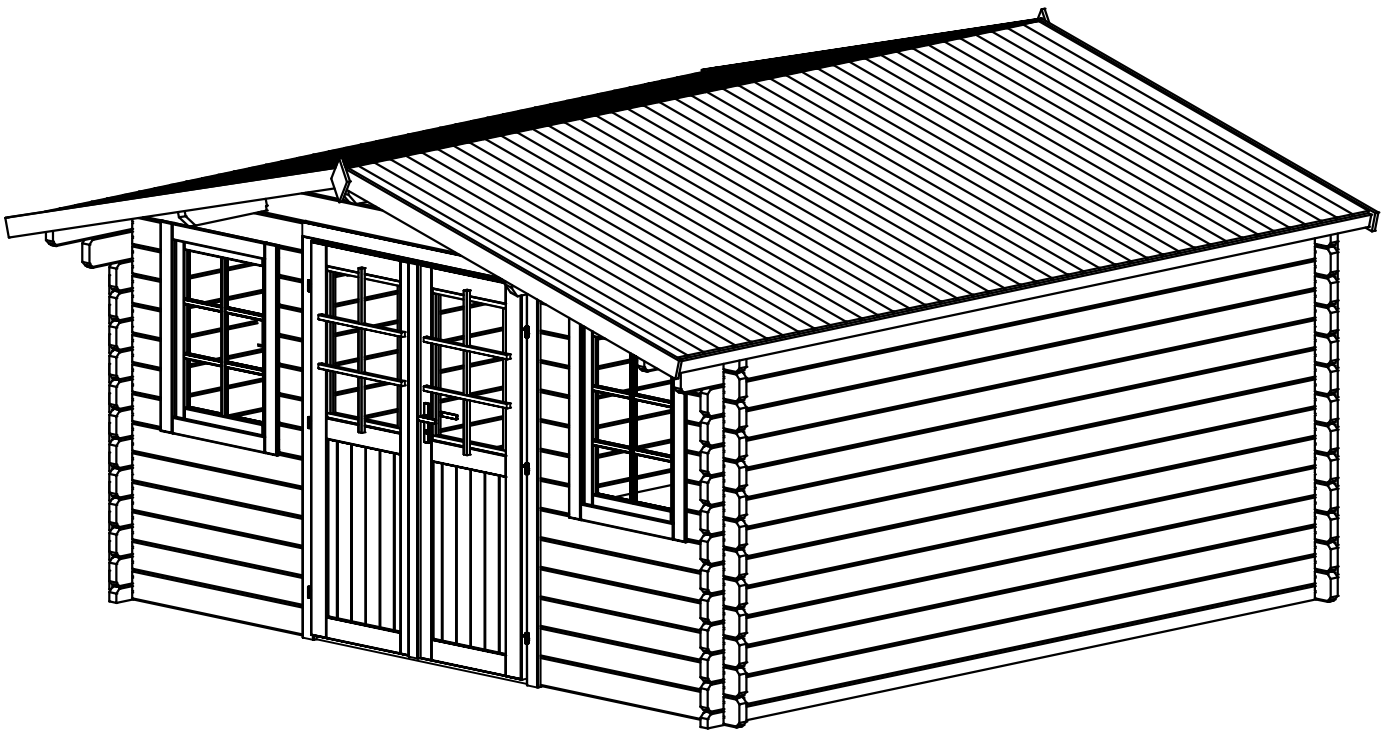





## München 5 ISO

### 3.98 x 3.98 m, 44mm

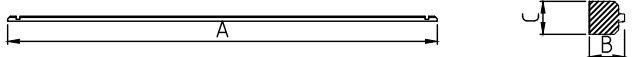



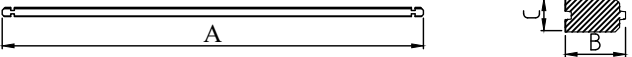
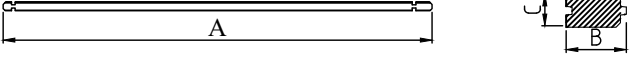
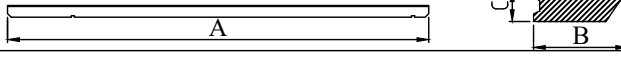
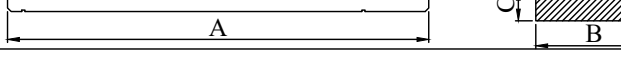
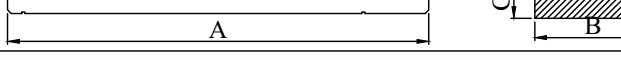
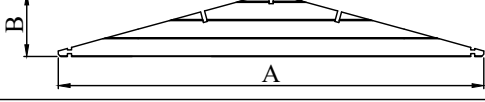
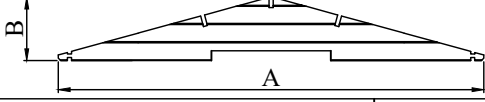
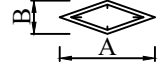
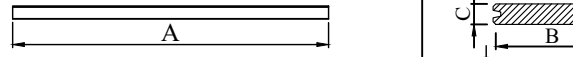
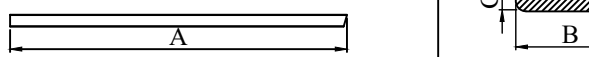
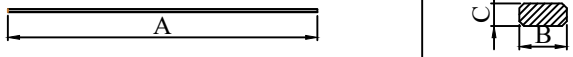
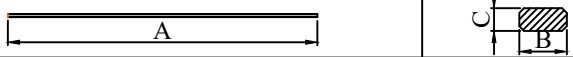
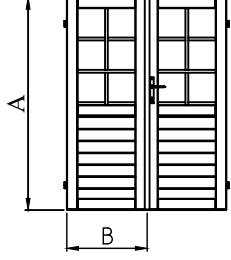

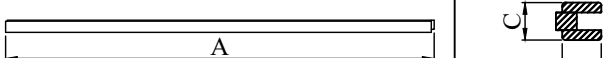
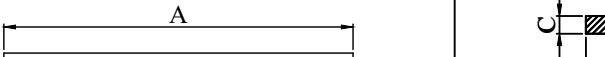
Before beginning the assembly of your garden shed, please read the instructions carefully and follow them closely. By doing so you will avoid unnecessary problems and save time. It is recommended to start the assembly process only once all the components of your shed have been identified, analyzed and classified.

# LIST OF ALL PARTS

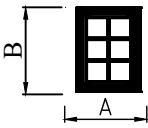
Nr.	Quantity	Dimension, mm			Details
		A	B	C	
A1	x 2	3980	67,5	44	
A2	x 12	1280	135	44	
A3	x 14	350	135	44	
A4	x 14	215	135	44	
A5	x 35+1	3980	135	44	
A6	x 2	4180	135	44	
A7	x 1+1	4480	135	44	
1	x 2	4480	140	44	
2	x 1	4480	140	44	
3	x 1	3980	540	44	
4	x 1	3980	540	44	
5	x 2	220	100	19	
6	x 100+2	2100	90	17	
7	x 2+2	2140	90	19	
8	x 6	1490	40	16	
9	x 4	2240	75	19	
10	x 1+1	1820	665	40	
B1	x 1	1524	82	90	
B2	x 2	1860	90	82	
B3	x 1	1320	44	40	

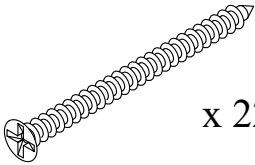
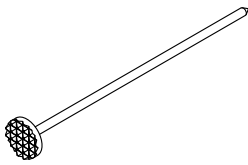
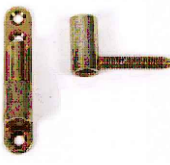
## LIST OF ALL PARTS

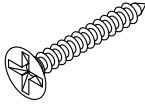
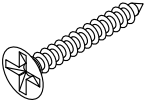
11	x 2	775	1410	82		
----	-----	-----	------	----	---	--

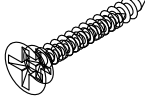
5 x 90	2 x 40	09 13 GZN	501/33Fe/HME
 x 22	 x 310	 x 6	 x 2
4 x 30	3,5 x 35	WRO50	AH9213
 x 76	 x 32	 x 2	 x 1
3 x 20			
 x 12			

# Assembly of walls and the frame of door

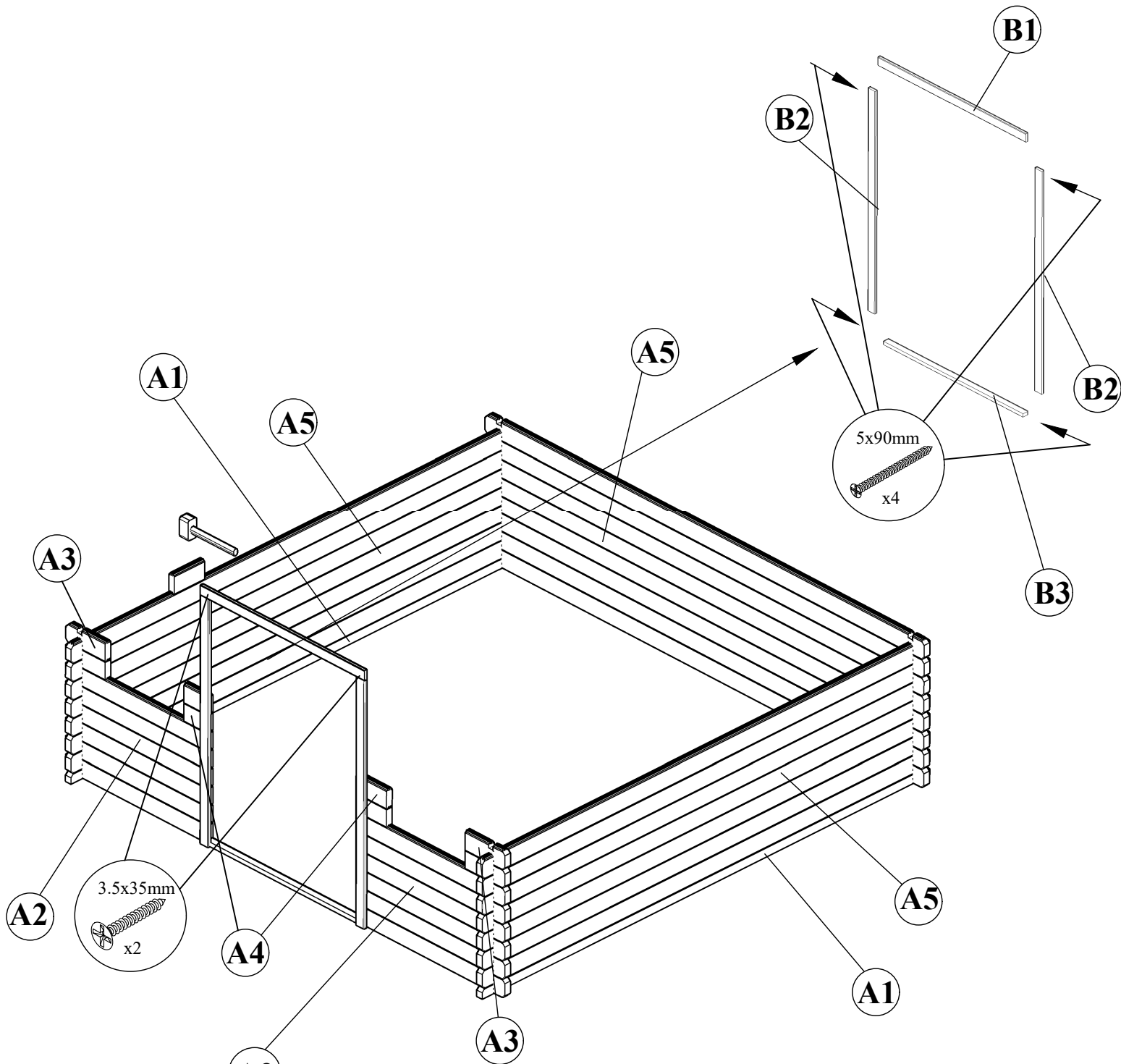

Position	Dimension (mm)	Quantity
A1	3980 x 67.5 x 44	2
A2	1280 x 135 x 44	12
A3	350 x 135 x 44	14
A4	215 x 135 x 44	14
A5	3980 x 135 x 44	35 + 1
B1	1524 x 90 x 82	1
B2	1860 x 90 x 82	2
B3	1320 x 40 x 44	1

# Assembly of top wall-boards

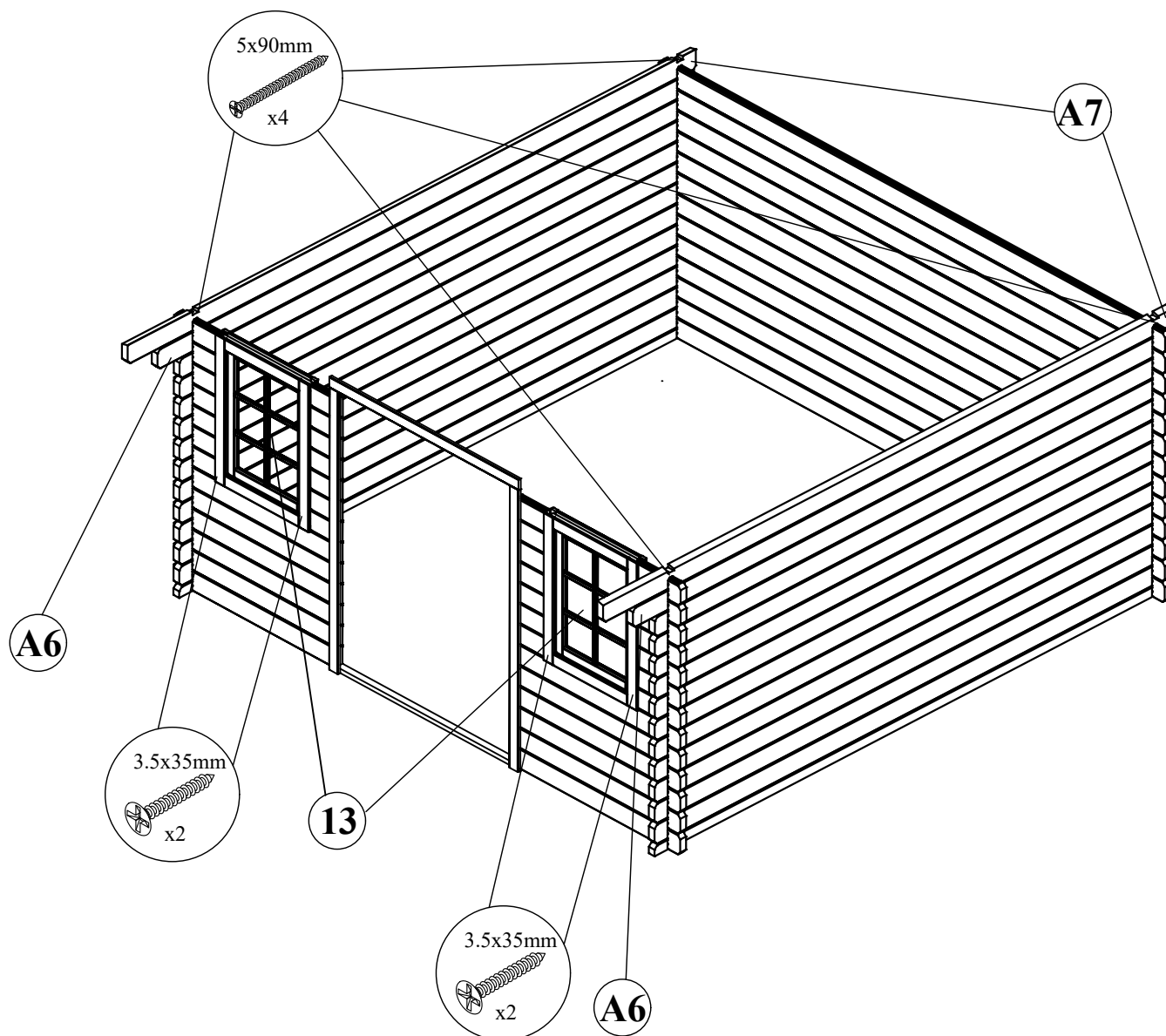
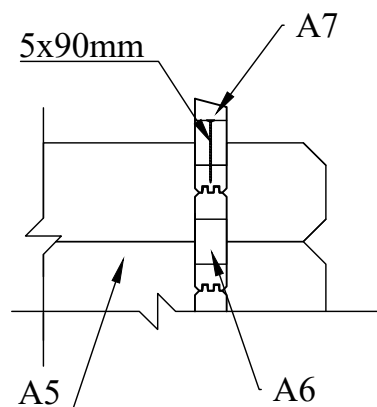
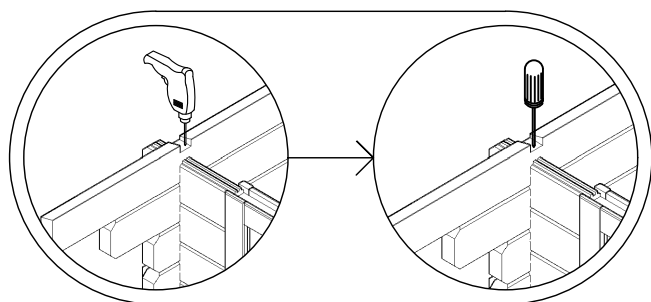

Position	Dimension (mm)	Quantity
A6	4180 x 135 x 44	2
A7	4480 x 140 x 44	1+1
11	775 x 1035 x 82	2

# Assembly of gables and roof beams

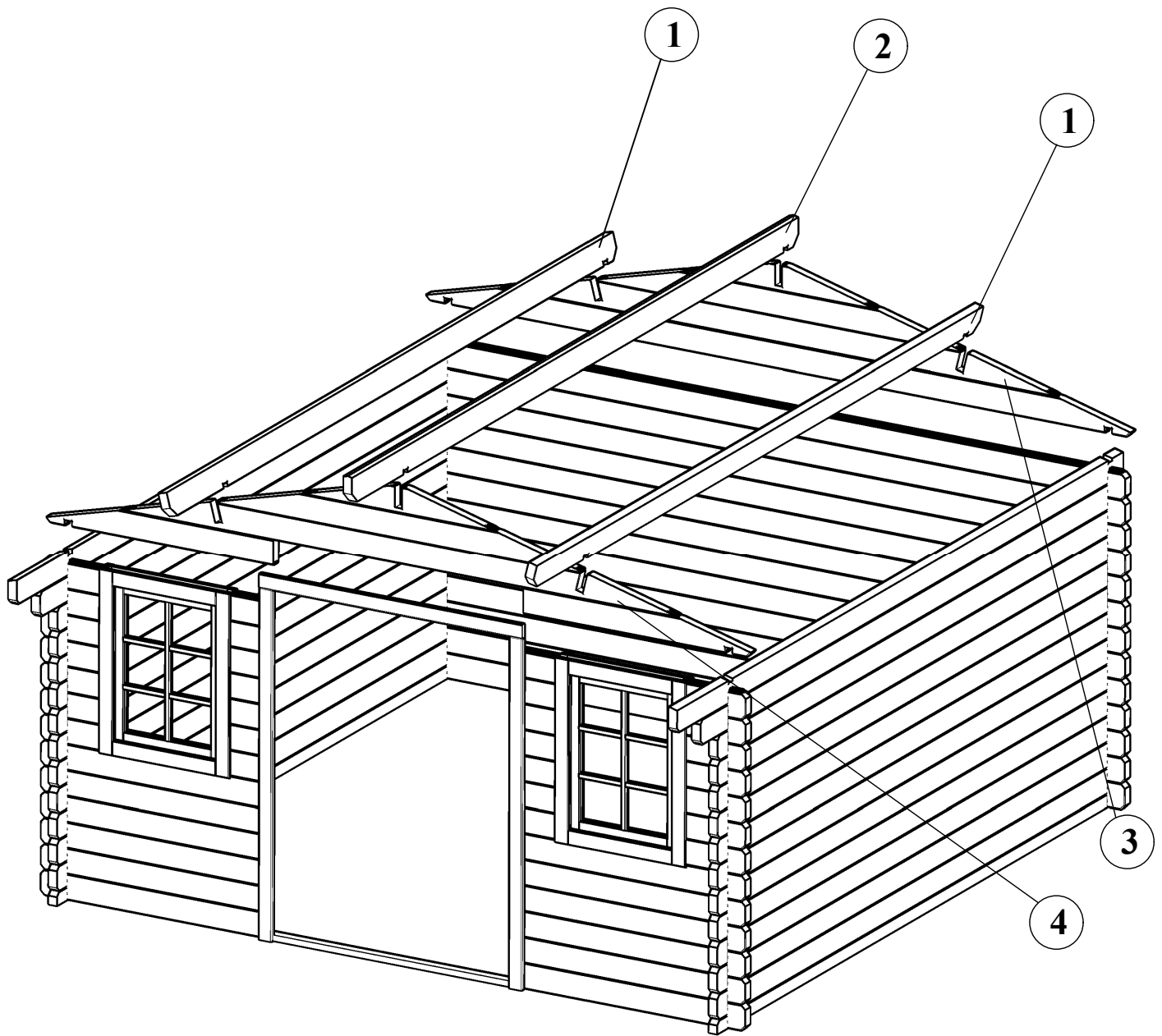

Position	Dimension (mm)	Quantity
1	4480 x 140 x 44	2
2	4480 x 140 x 44	1
3	3980 x 540 x 44	1
4	3980 x 540 x 44	1

# Fixing gables and roof beams

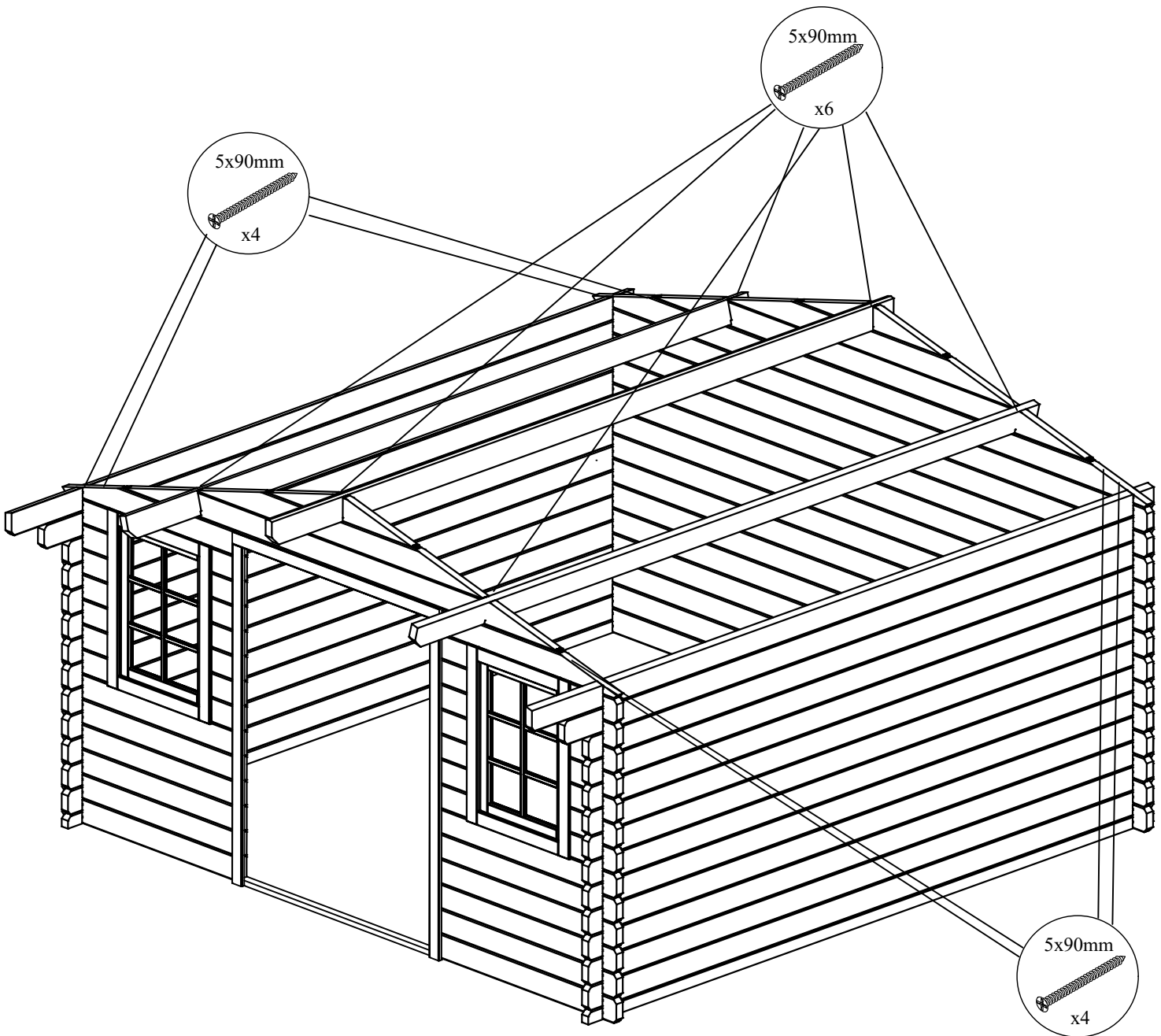
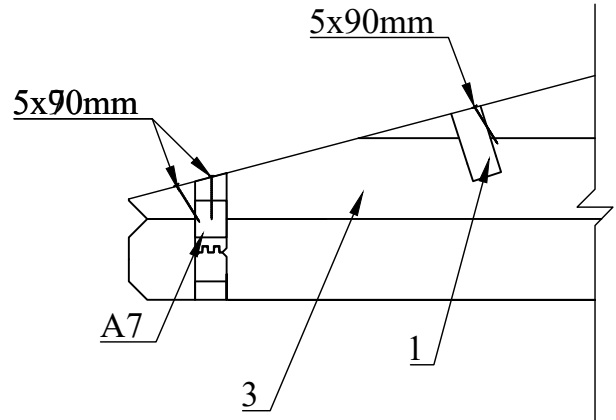
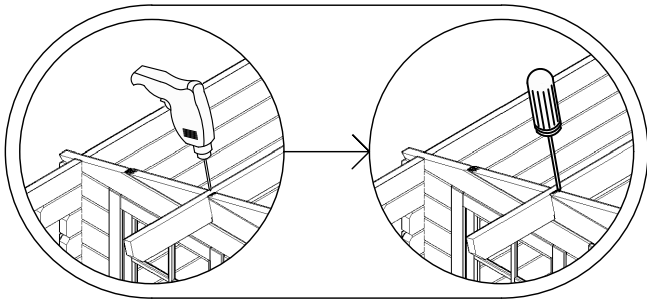

# Installing the roof board

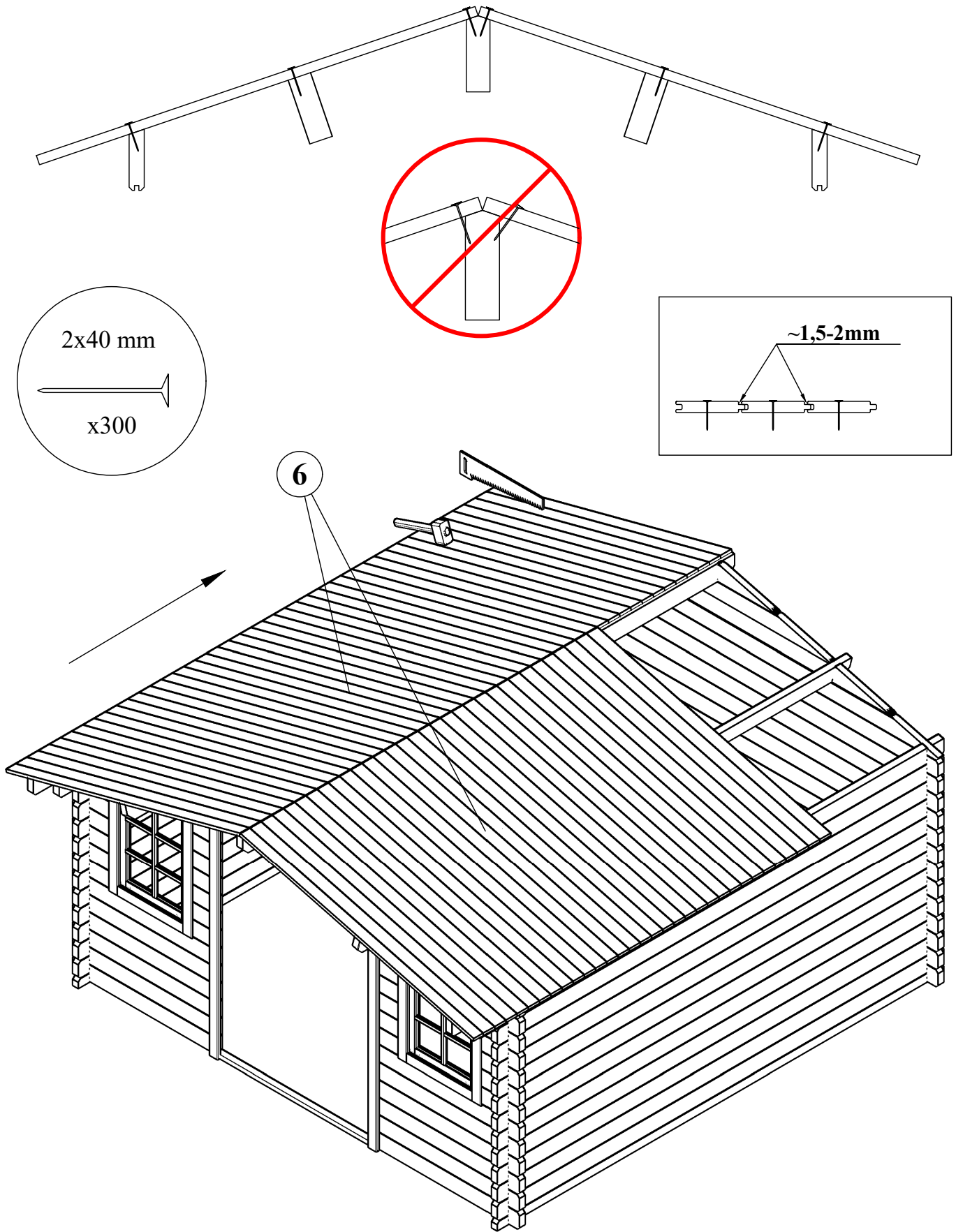

Position	Dimension (mm)	Quantity
6	2100 x 90 x 17	100 (+2)



# Installing fascia

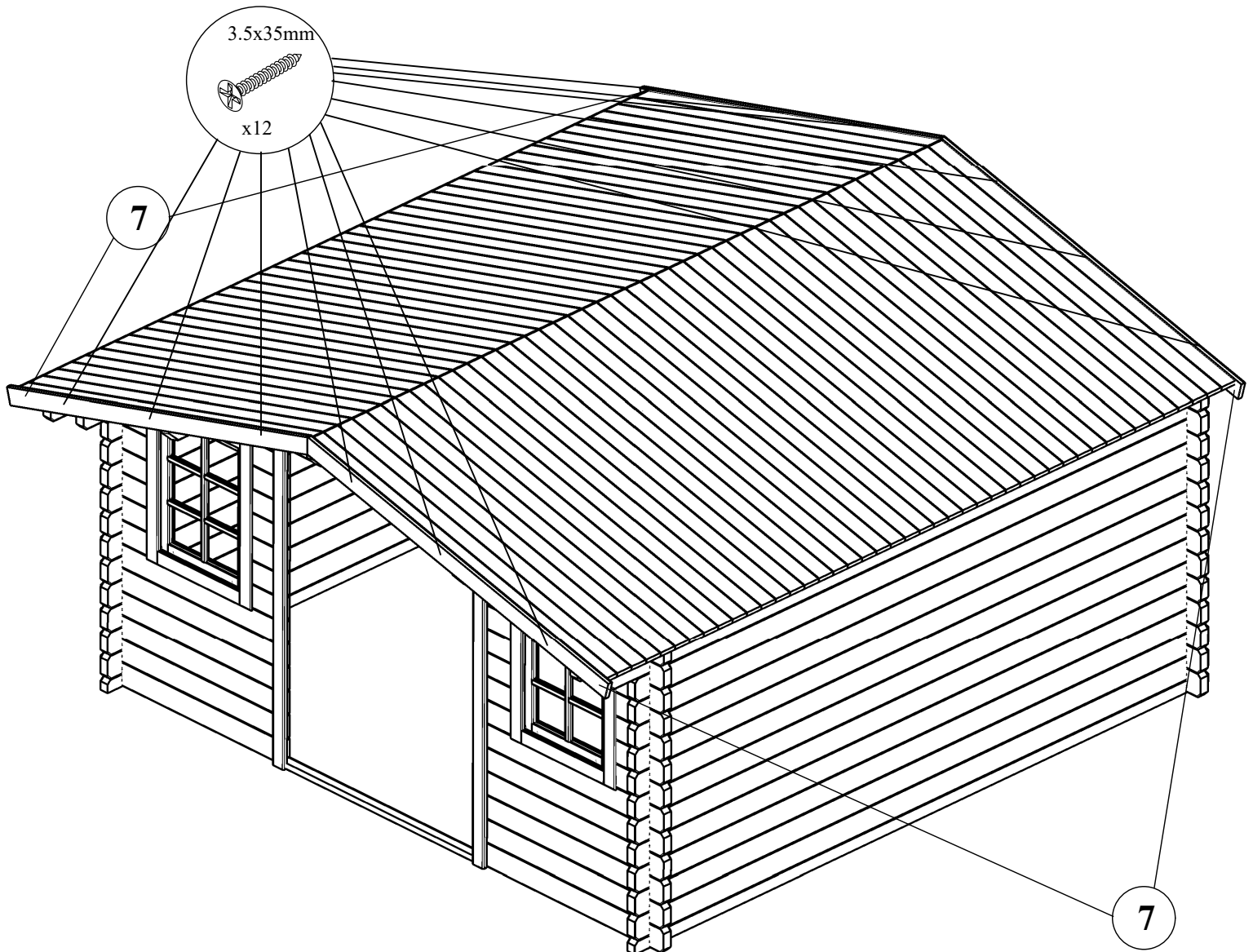

Position	Dimension (mm)	Quantity
7	2140 x 90 x 19	2+2

# Installing fascia

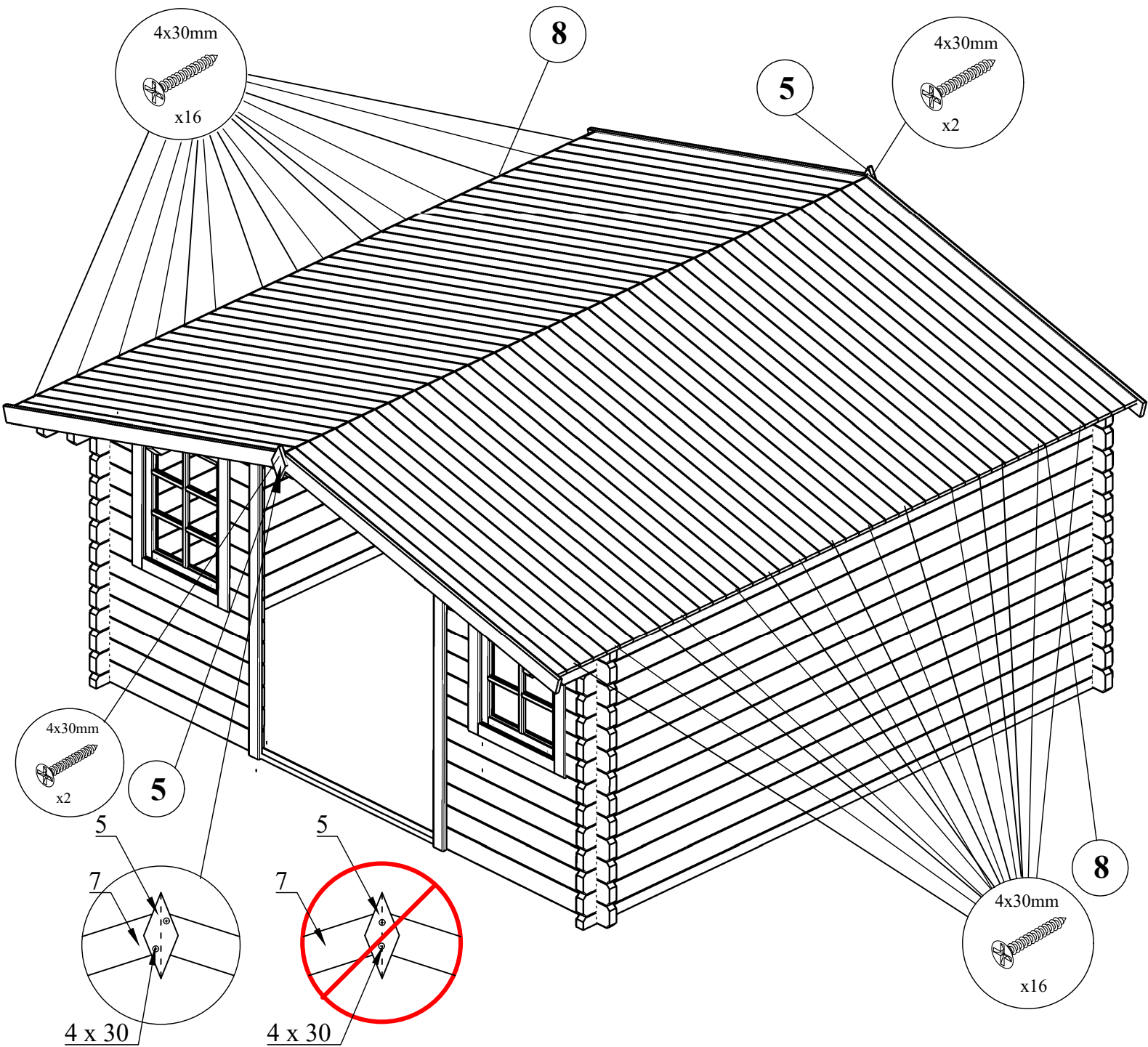

Position	Dimension (mm)	Quantity
8	1490 x 40 x 16	6
5	220 x 100 x 19	2

# Installing fascia

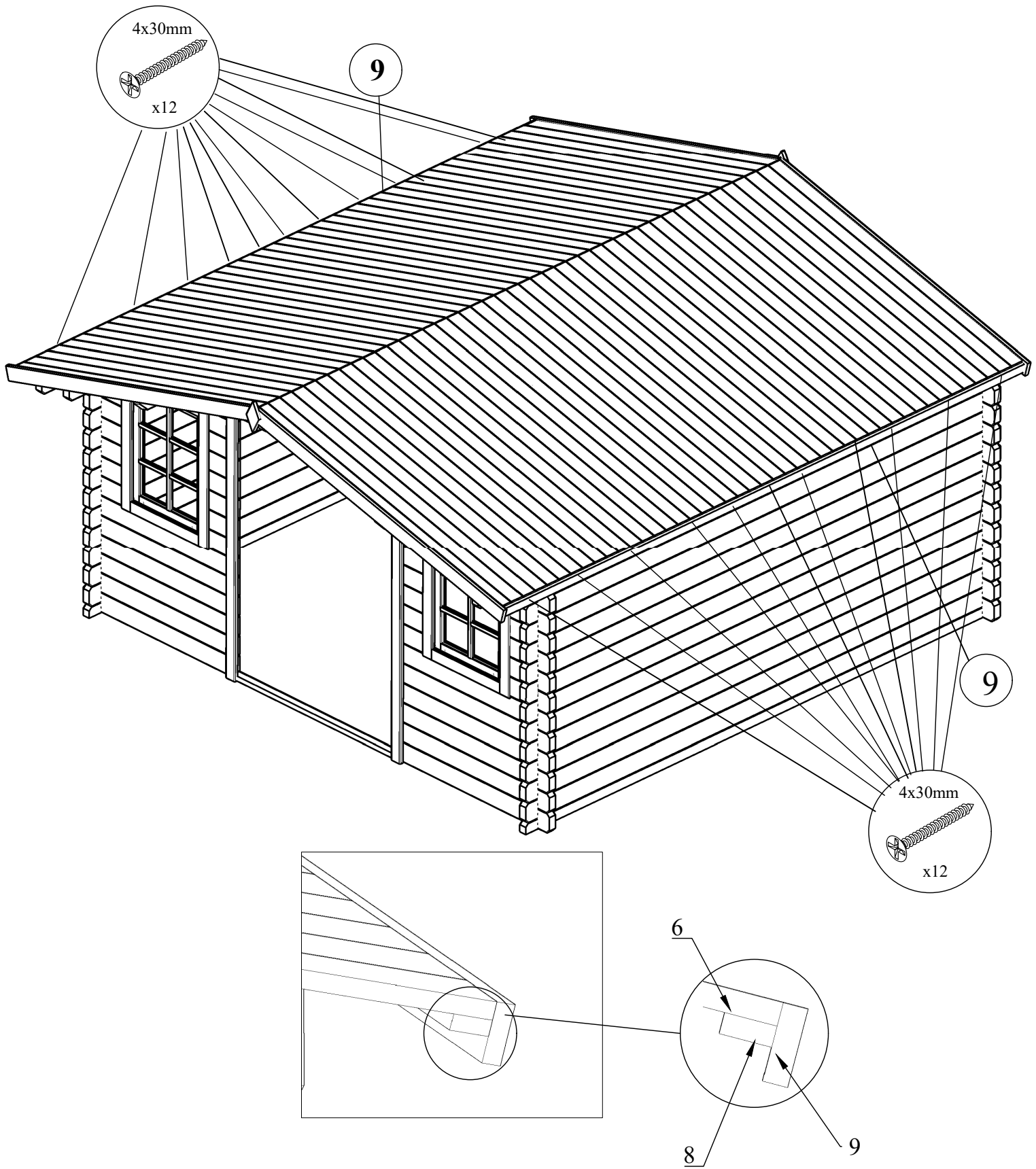

Position	Dimension (mm)	Quantity
9	2240 x 75 x 19	4

# Installing the door

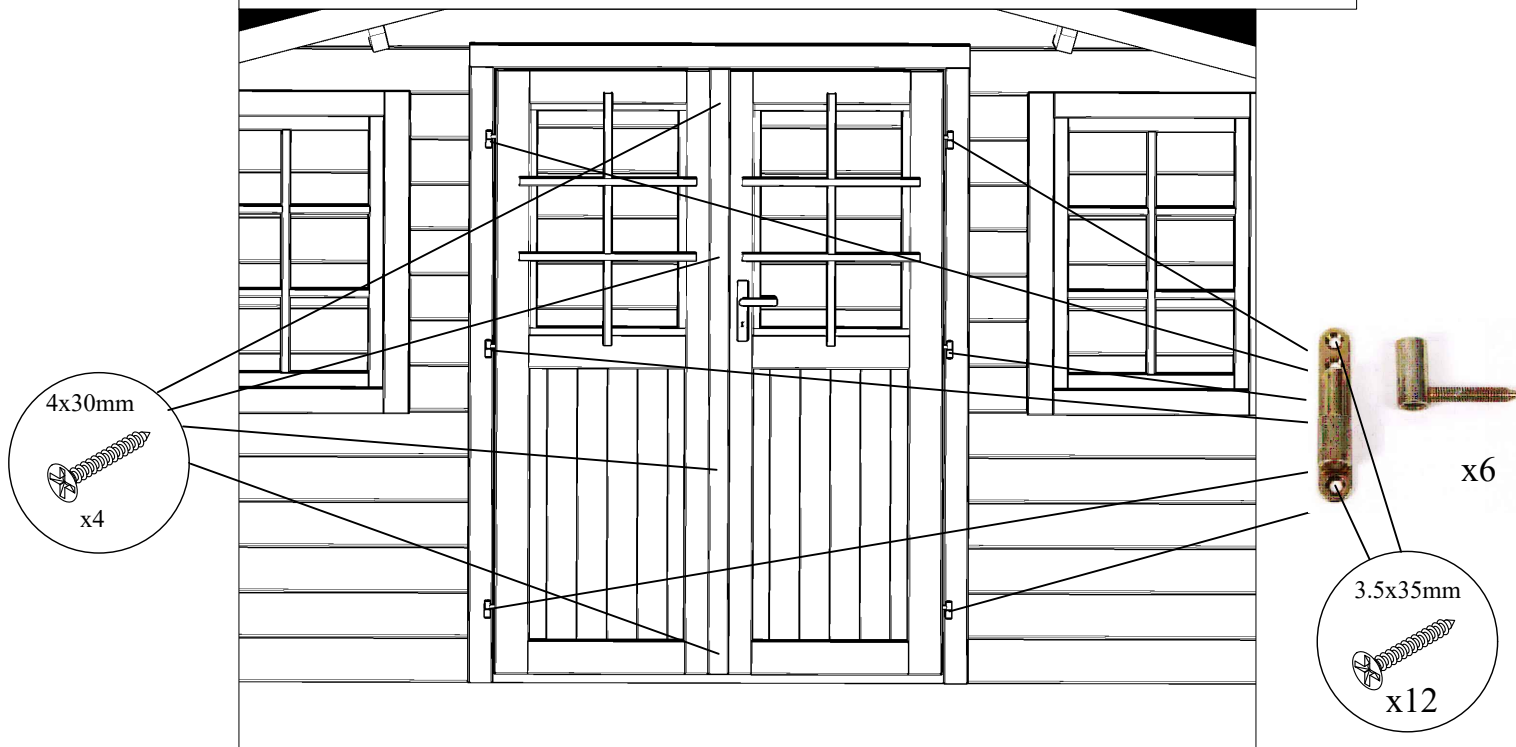
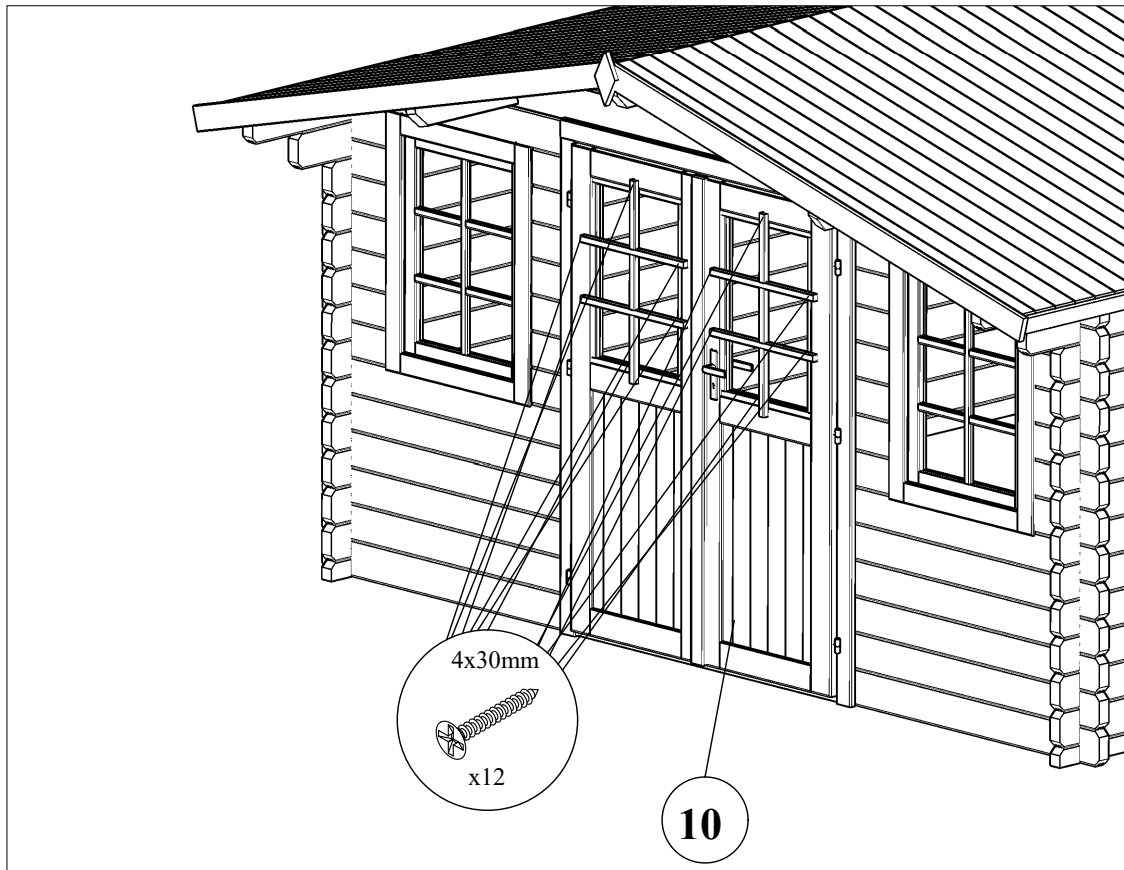

Position	Dimension (mm)	Quantity
10	1820 x 665	1 + 1

# Installing the handles and the doorshuts

