

Art. Nr. 9915700

1/6

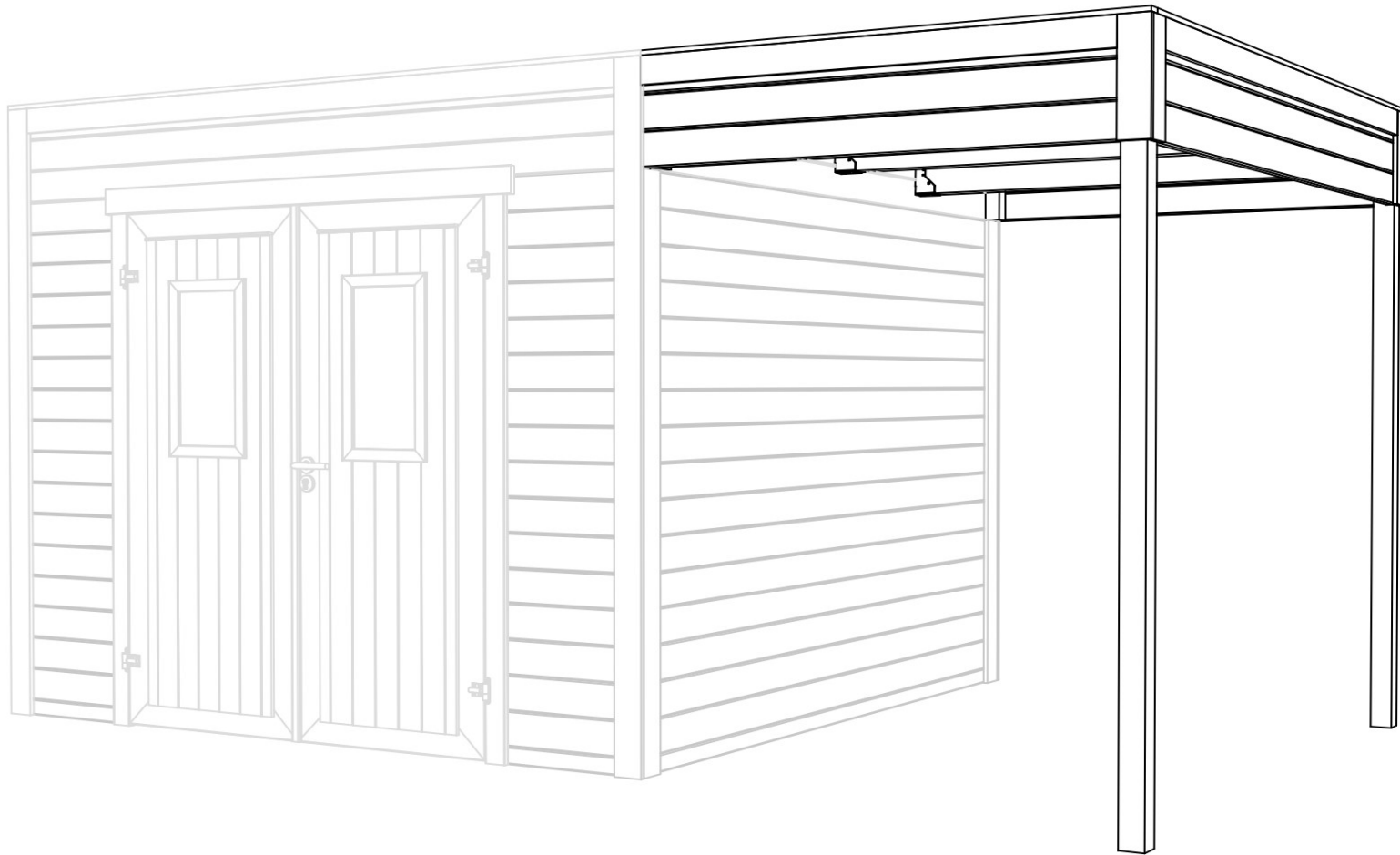

05.06.2024

Art.Nr. 9915700

Groundplan - Grundplan - Plan de masse - Planimetria - Plattegrond - Planimetría
- Põhiplaan

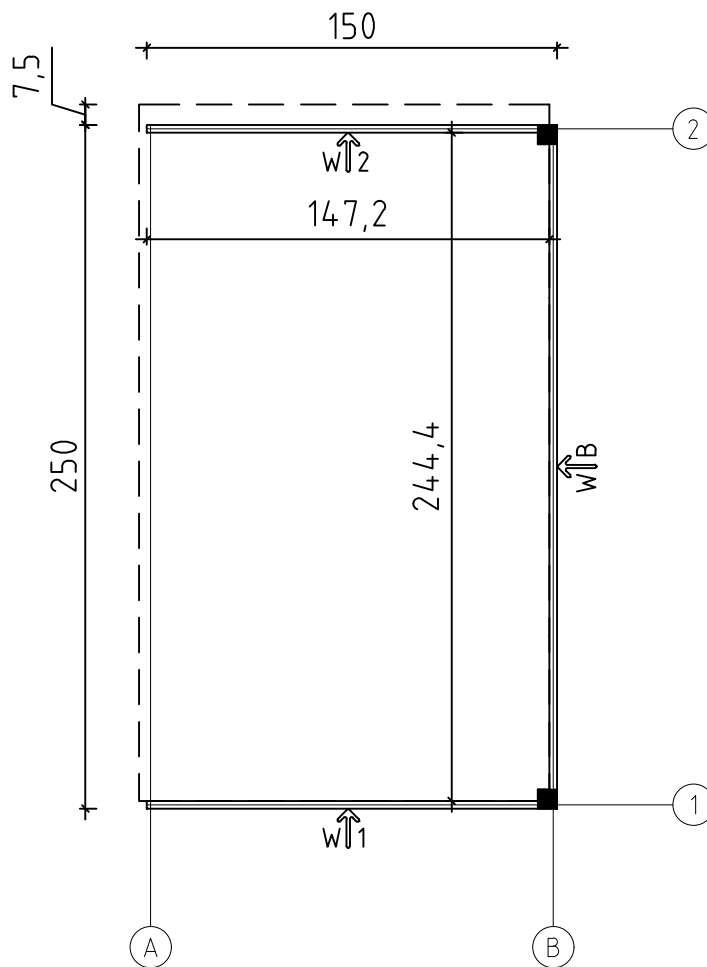

Art.№. 9915700

20
19
18

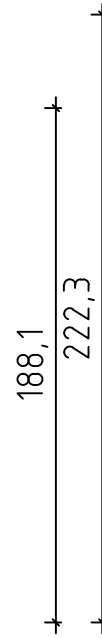
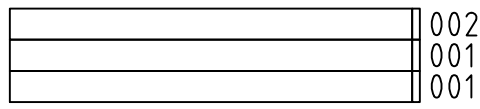

W-1

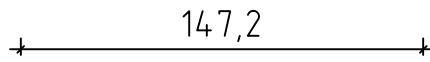

(B)

20
19
18

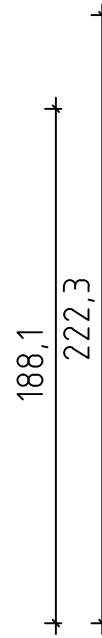
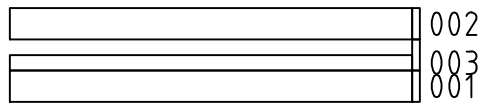

W-2

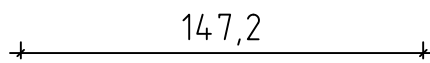

(B)

Art.Nr. 9915700

20
19
18

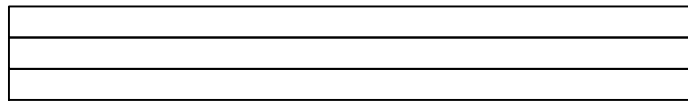



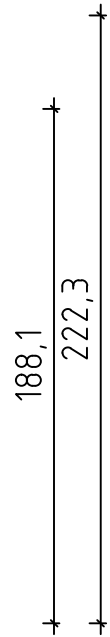



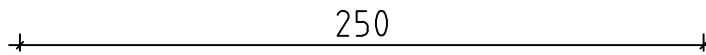



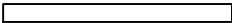
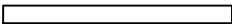
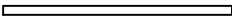
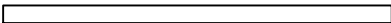
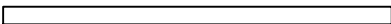
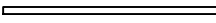

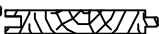
005
004
004

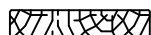
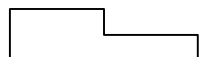
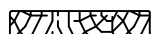
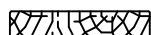
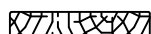

W-B ↗

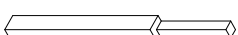
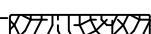

250

Pos	Piece list - Stückliste - Liste des pièces - Elementi - Stuklijst - Elementos - Tükítabel 05.06.2024 Art.Nr. 9915700 5/6	Q	P (mm)	L (mm)
001 28933		3	28x114	1472
002 49056		2	28x114	1472
003 49057		1	28x57	1472
004 6141		2	28x114	2500
005 43025		1	28x114	2500
RV1 49058	Lath - Pfetten - Liteau - Piccola asse - Gordingen - Vigüeta - Roov 	1	44x44	1375
A-PR1 49059	Roof beam - Dachbalken - Panne de toit - Perlina del tetto - Gordingen / dakbalk - Correa - Pärlin 	3	44x146	1464
RB-1 28028	Roof boards - Dachbretter - Voliges - Perlina per tetto - Dakhout - Tablero de tejado - Katuselaud 	17	90x15.5	2550
DPL-2 22827	Roofing felt fillet - Dachpappenleiste - Baguette de fixation du feutre bitumeux - Asse per fissaggio guaina bituminosa - Afdekljst asfaltpapier - Moldura de fieltro para tejado - Katusepapiliist 	2	15x45	1500
DPL-1 48989	Roofing felt fillet - Dachpappenleiste - Baguette de fixation du feutre bitumeux - Asse per fissaggio guaina bituminosa - Afdekljst asfaltpapier - Moldura de fieltro para tejado - Katusepapiliist 	1	15x45	2440
TBE6-1 42305	Corner fillet - Deckleiste - Profils de finition angles a l'exterieur - Massello d'angolo - (hoek)lijst - Moldura de esquina - Nurgaliist 	3	15x90	342
TBE6-2 49027	Corner fillet - Deckleiste - Profils de finition angles a l'exterieur - Massello d'angolo - (hoek)lijst - Moldura de esquina - Nurgaliist 	1	15x90	342
PL8-2 49060	Railing strip - Begrenzungsleiste - Rembarde - Sbarra - Afscheidingslijst - Tablero limitador - Piirdelaud 	1	15x90	1410
PL8-3 49061	Railing strip - Begrenzungsleiste - Rembarde - Sbarra - Afscheidingslijst - Tablero limitador - Piirdelaud 	1	15x90	1500
PL8-1 48990	Railing strip - Begrenzungsleiste - Rembarde - Sbarra - Afscheidingslijst - Tablero limitador - Piirdelaud 	1	15x90	2320
P1-1 46430	Post - Pfosten - Poteau - Piede registrabile - Stijl - Poste - Post 	1	55x55	171
P1-2 48608	Post - Pfosten - Poteau - Piede registrabile - Stijl - Poste - Post 	1	55x55	298
P3-1 49030	Post - Pfosten - Poteau - Piede registrabile - Stijl - Poste - Post 	1	70x70	2112
P3-2 49031	Post - Pfosten - Poteau - Piede registrabile - Stijl - Poste - Post 	1	70x70	2239
TB1-1 22827	Fascia board - Traufbrett - Bandeau de toit - Finitura lati tetto - Gevellijst - Tablero de alero - Räästalaud 	1	15x45	1500
HS4 5102	Screw for corner fillet - Schraube zur befestigung deckleiste - Vis pour profils de finition angles a l'exterieur - Viti per massellino d'angolo - Schroef voor afdekljst (hoek) - Tornillo para moldura de esquina - Kruvi nurgaliistule 	30	3x30	
HS4 5102	Screw for covering moulding - Schrauben für deckungsprofil - Vis de fixation profils horizontaux haut inférieure et extérieur d'encadrement de porte - Vite per cornice di copertura - Schroef voor afdekprofiel - Tornillo para tablero delimitador - Kruvi piirdelauale 	30	3x30	
HS4 5102	Screw for fascia boards - Schrauben für traufbretter - Vis pour fixation bandeau de toit - Viti x striscia del tetto - Schroef voor gevellijst - Tornillo para tablero de alero - Kruvi räästalauale 	4	3x30	

