

*Pingo*  
*Art. Nr. 199600*  
*1/16*

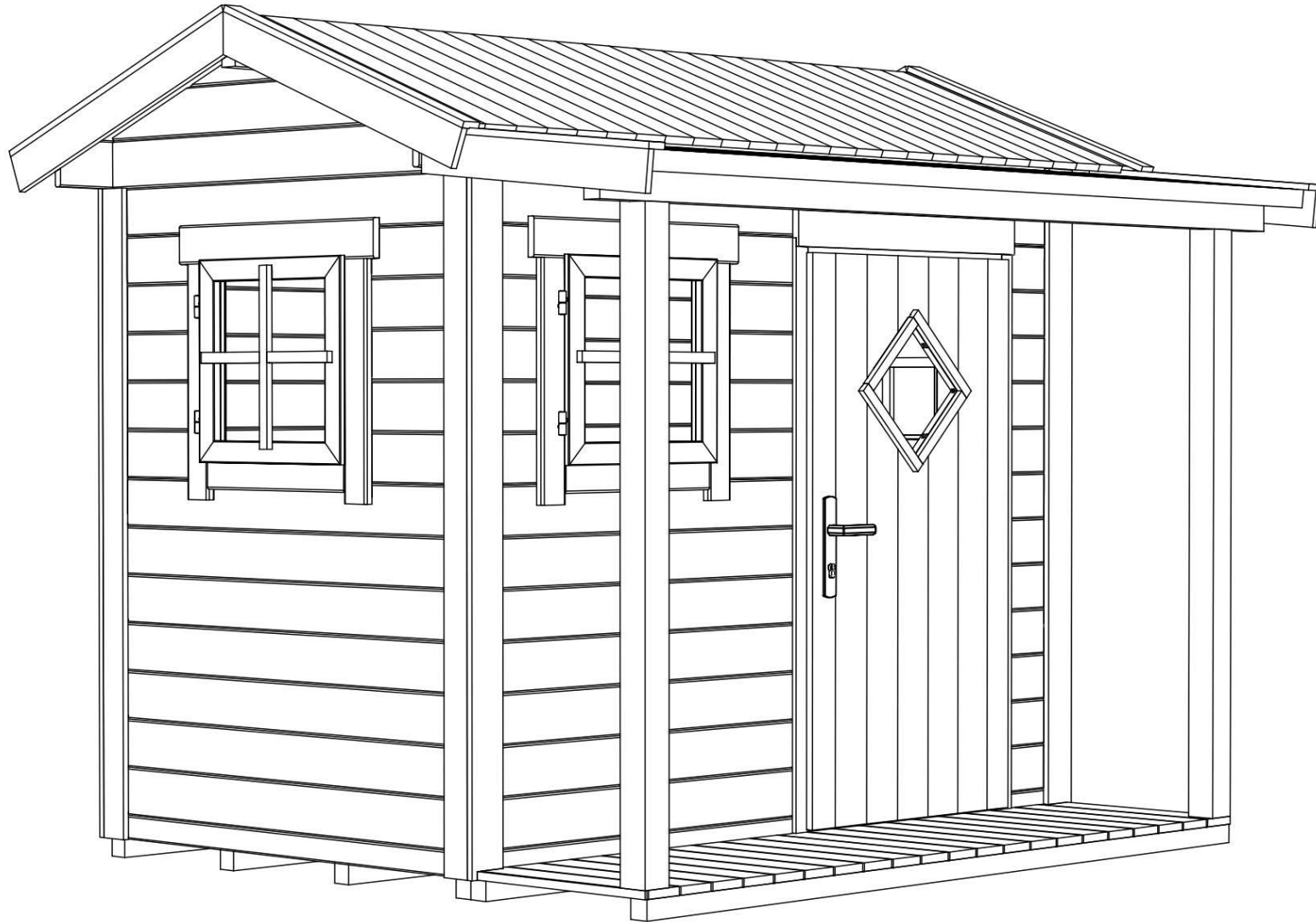

18.02.2022

Art. Nr. 199600

Groundplan - Grundplan - Plan de masse - Planimetria - Plattegrond  
- Põhiplaan

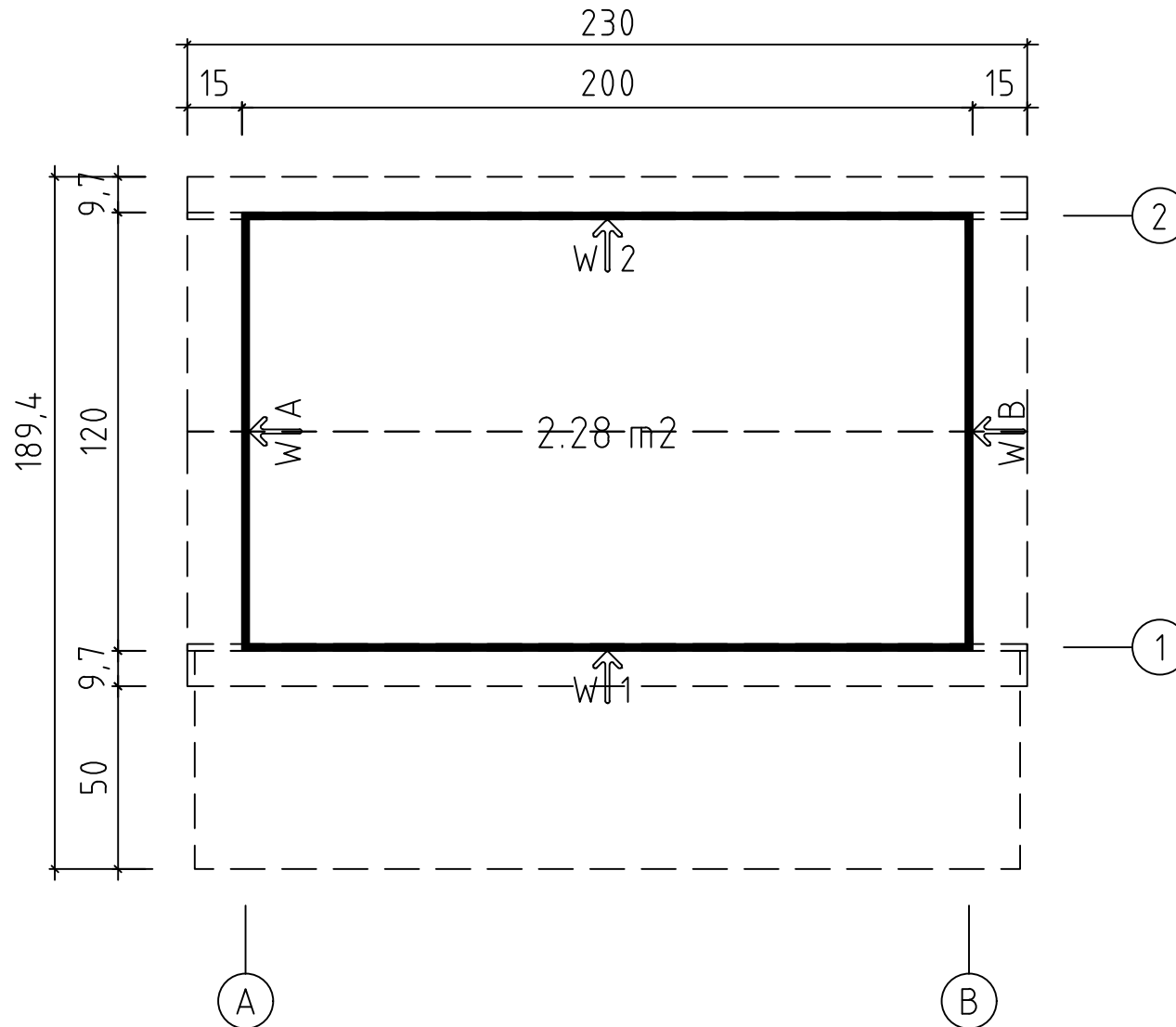

Art. Nr. 199600

Foundation - Fundament - Fondation - Fondamenta - Fundering -  
Immutatud alusraam

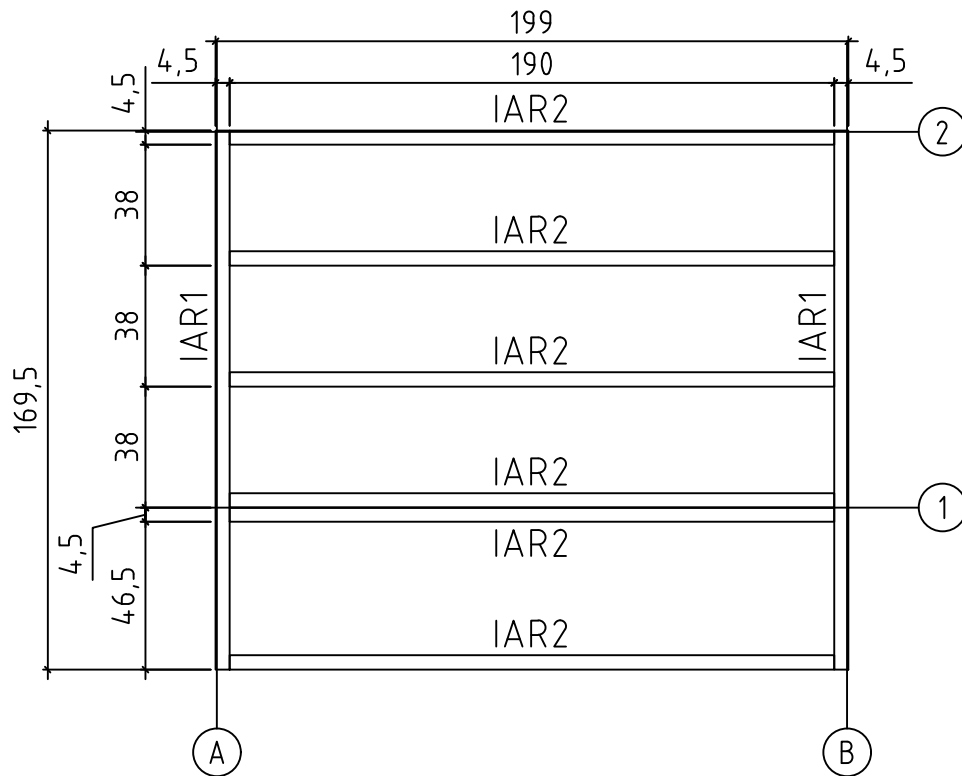

Floor boards - Fussbodenbretter - Plan pose plancher - Pavimento -  
Vloerhout - Põrandalaudis

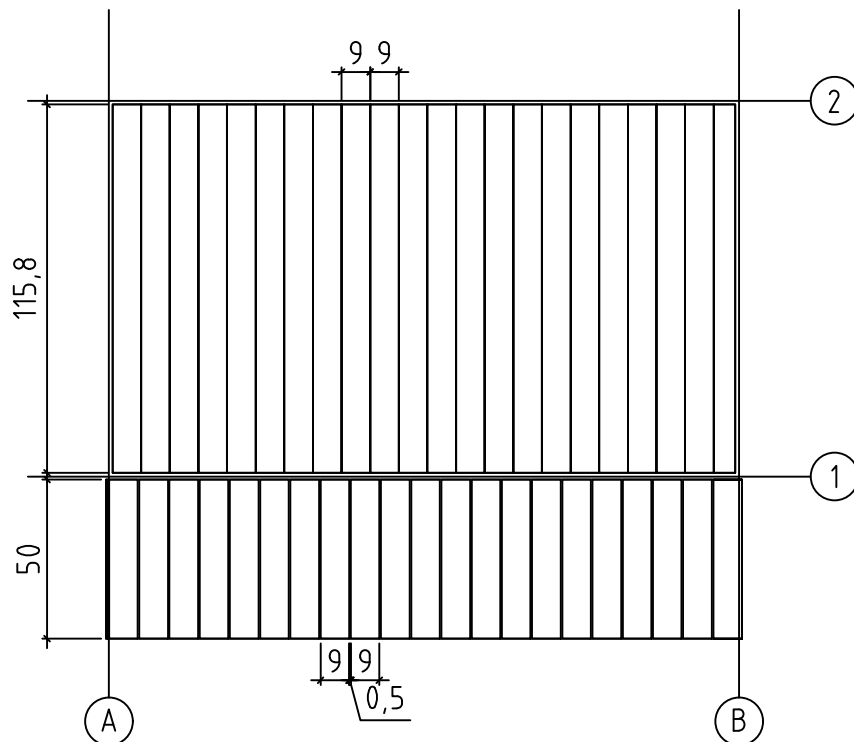





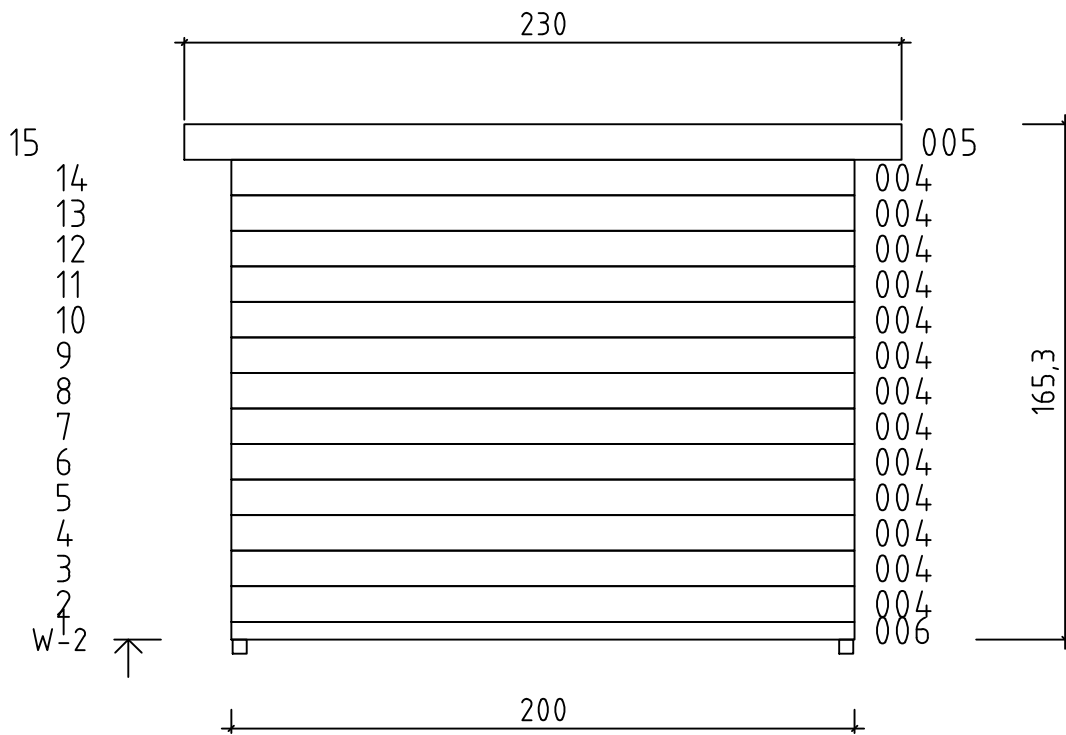
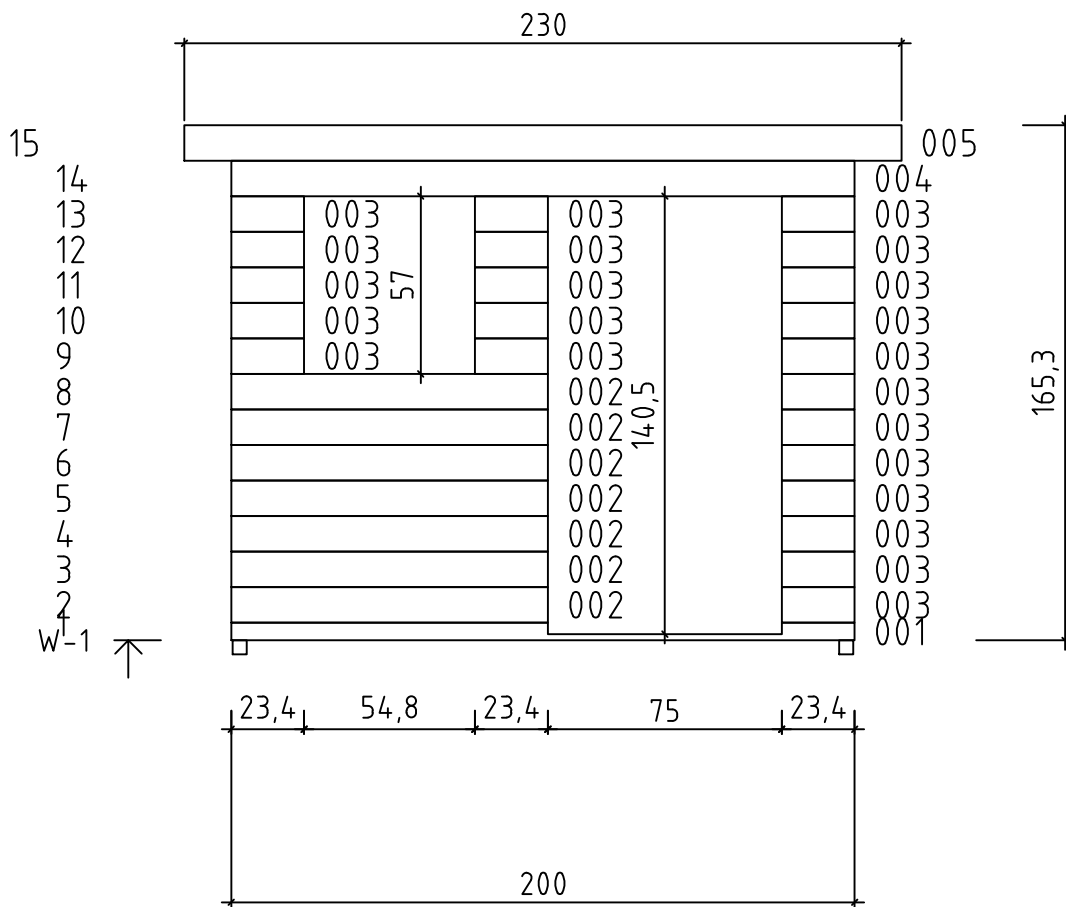



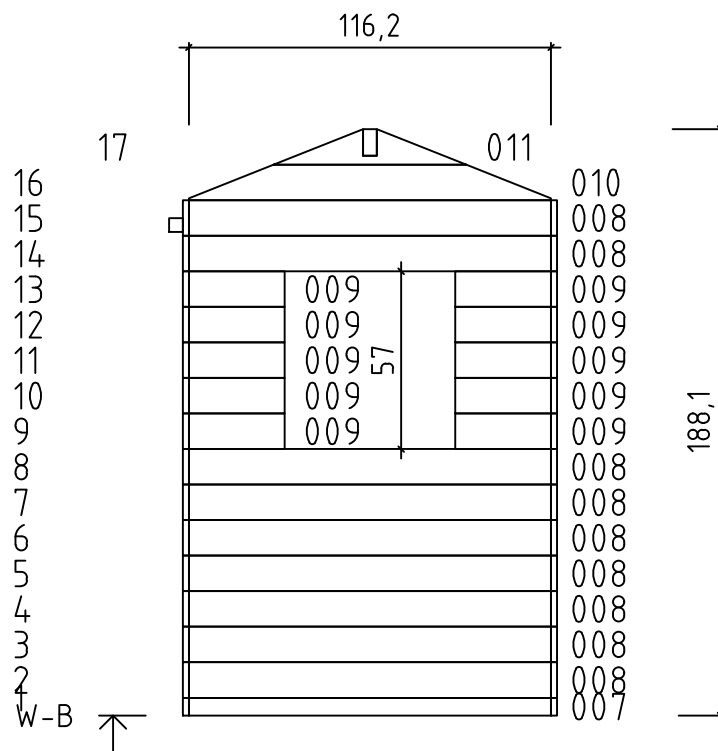
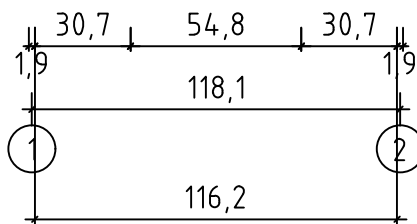
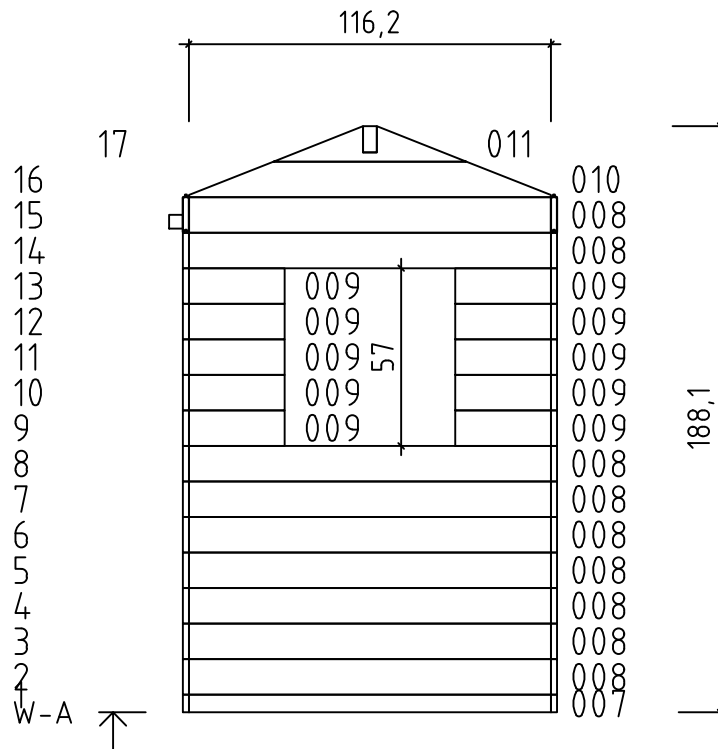







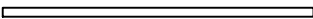

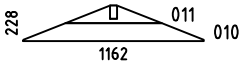
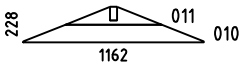

Terrace boards - Terrassenbretter - Plancher de terrasse -  
Piattaforme terrazzo - Terrasvloer - Terrassilaudis



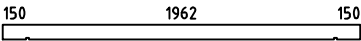





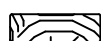
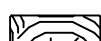
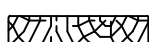

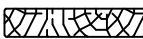
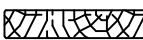

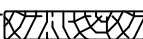
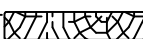
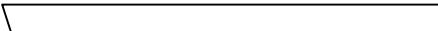
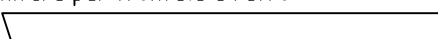
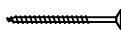
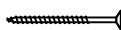
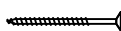
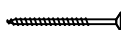
Art. Nr. 199600



Art. Nr. 199600



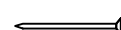







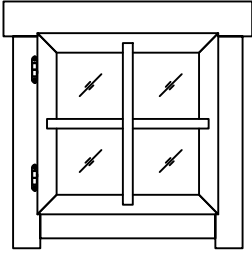
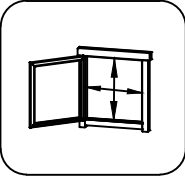
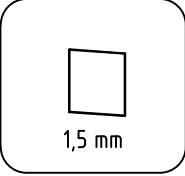

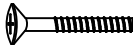
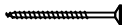

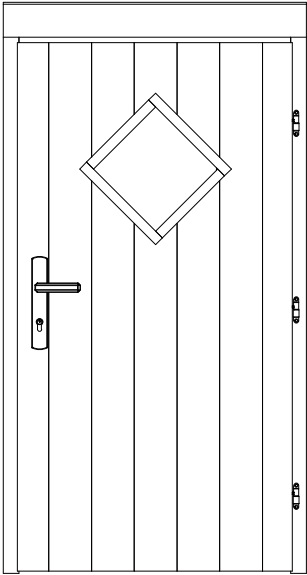
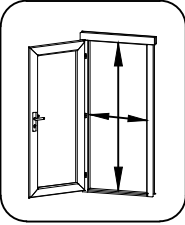
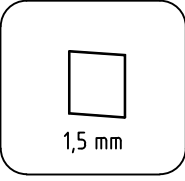
Pos	18.02.2022 Piece list - Stückliste - Liste des pièces - Elementi - Stuklijst - Tükitalabel Art. Nr. 199600 6/16	Q	P (mm)	L (mm)
001		1	19x57	2000
002		7	19x114	1016
003		22	19x114	234
004		14	19x114	2000
005		2	19x114	2300
006		1	19x57	2000
007		2	19x57	1162
008		18	19x114	1162
009		20	19x114	307
WA-1		1		
WB-1		1		
IAR2	Foundation - Fundament - Fondation - Fondamenta - Fundering - Immutatud alusraam 	6	45x45	1900
IAR1	Foundation - Fundament - Fondation - Fondamenta - Fundering - Immutatud alusraam 	2	45x45	1695
RV1	Lath - Pfetten - Liteau - Piccola asse - Gordingen - Roov 	1	44x44	2260
A-PR1	Roof beam - Dachbalken - Panne de toit - Perlina del tetto - Gordingen / dakbalk - Pärilin 	1	44x95	2300
FB	Floor boards - Fussbodenbretter - Lame de plancher - Pavimento - Vloerhout - Pörandalaud 	22+1	90x15	1158
TB	Terrace boards - Terrassenbretter - Plancher de terrasse - Piattaforme terrazzo - Terrasvloer - Terrassilaud 	22+1	90x19	500
RB1	Roof boards - Dachbretter - Voliges - Perlina per tetto - Dakhout - Katuselaud 	52	90x15	750
RB2	Roof boards - Dachbretter - Voliges - Perlina per tetto - Dakhout - Katuselaud 	26	90x15	600
	Floor fillet - Fussbodenleiste - Corniere de finition du plancher - Finitura per pavimento (battisco pa) - Vloerafwerkljst - Pörandaliist 		18x18	7
DPL1	Roofing felt fillet - Dachpappenleiste - Baguette de fixation du feutre bitumeux - Asse per fissaggio guaina bituminosa - Afdekljst asfaltpapier - Katusepapiilist 	2	15x45	650
DPL2	Roofing felt fillet - Dachpappenleiste - Baguette de fixation du feutre bitumeux - Asse per fissaggio guaina bituminosa - Afdekljst asfaltpapier - Katusepapiilist 	4	15x45	800
CF1	Corner fillet - Deckleiste - Profils de finition angles a l'exterieur - Massello d'angolo - (hoek)lijst - Nurgaliist 	4	15x70	1539

Pos	18.02.2022 Piece list - Stückliste - Liste des pièces - Elementi - Stuklijst - Tükitalabel Art. Nr. 199600 7/16	Q	P (mm)	L (mm)
CF2	Corner fillet - Deckleiste - Profils de finition angles a l'exterieur - Massello d'angolo - (hoek)lijst - Nurgaliist 	2	15x90	1520
CF3	Corner fillet - Deckleiste - Profils de finition angles a l'exterieur - Massello d'angolo - (hoek)lijst - Nurgaliist 	2	15x90	1640
CS	Corner stud - Eckpfosten - Poteaux d'angle pour fixation des madriers - Perno angolare - Hoek staander (kolom) - Nurgapost 	4	44x44	1635
P	Post - Pfosten - Poteau - Piede registrabile - Stijl - Post 	2	70x70	1493
TB-1	Fascia board - Traufbrett - Bandeau de toit - Finitura lati tetto - Gevellijst Räästalaud 	1	15x45	2260
TB-2	Fascia board - Traufbrett - Bandeau de toit - Finitura lati tetto - Gevellijst Räästalaud 	1	15x45	2300
B	Beam - Balkenlage - Solive(s) - Trave - Balk (gording) - Tala	1	44x95	2260
GM1	Gable moulding - Giebelleiste - Planche de rive - Finitura per frontale e retro del tetto - Gevellijst - Viilulaud 	2	15x120	650
GM2	Gable moulding - Giebelleiste - Planche de rive - Finitura per frontale e retro del tetto - Gevellijst - Viilulaud 	4	15x120	800
HS8	Screw for corner fillet - Schraube zur befestigung deckleiste - Vis pour profils de finition angles a l'exterieur - Viti per massellino d'angolo - Schroef voor afdekljst (hoek) - Krugi nurgaliistudele 	60	3.5x35	
HS9	Screw for wall details - Schraube für wand details - Vis pour mur details - Viti per elementi della porta - Schroef voor wand details - Krugi seinte montaažiks 	240	3.5x50	
HS9	Screw for gable moulding - Schrauben für giebelleiste - Vis pour fixation planche de rive - Vite per fissare finiture davanti e dietro del tetto - Schroef voor gevellijst - Krugi viilulauale 	24	3.5x50	
HS9	Screw for assembly battens - Schrauben für montagelatte - Vis de fixation des baguettes de maintien pour mise en place du toit - Viti per assemblaggio stecca - Schroef voor montage lat - Krugi montaažilatile 	12	3.5x50	
HS4	Screw for fascia boards - Schrauben für traufbretter - Vis pour fixation bandeau de toit - Viti x striscia del tetto - Schroef voor gevellijst - Krugi räästalauale 	12	3x30	
HS12	Screw for metal corner - Holzschraube für metallwinkel - Vis de fixation des cornieres en métal - Viti per fissare suadretta di metallo di giunzione - Schroef voor metalen hoek - Krugi nurgikule 	24	4x40	
HS13	Screw for post - Schrauben für pfosten - Vis de fixation des poteaux - Viti per inviare - Schroef voor stijlen - Krugi postile 	12	4x60	
HS18	Screw for roof beams - Schrauben für dachbalken - Vis pour fixation pannes de toit - Viti per perline del tetto - Schroef voor gordingen / dakbalken - Krugi pärlinitile 	2	5x120	
HS18	Screw for gable - Schrauben für giebel - Vis pour fixation des pignons - Viti per timpano - Schroef voor gevelpunt - Krugi viilude kinnitamiseks 	4	5x120	
HS16	Screw for foundation - Schrauben zur befestigung fundament - Vis de fixations des poutrelles de fondations - Viti x fondamenta - Schroef voor fundering - Krugi alusraamile 	12	5x90	
HS16	Screw for foundation - Schrauben zur befestigung fundament - Vis de fixations des poutrelles de fondations - Viti x fondamenta - Schroef voor fundering - Krugi alusraamile 	2	5x90	
NF2	Zn nail for floor fillet - Zn nägel für fussbodenleiste - Pointe pour corniere de finition du plancher - Chiodi x fissaggio pavimento - Spijker(nagel) voor vloer afdekljst - Nael põrandaliistule 	16	1.4x40	
SH19	Hammer block - Schlagholz - Calle de frappe - Blocco di legno da usare come cuscinetto quando si usa il martello - Slagklos - Löögiklots 	1		
NF3	Zn nail for terrace - Zn nägel für terrassenbretter - Pointe pour plancher de terrasse - Chiodo zincato per terrazza - Spijker(nagel) voor terrasvloer - Nael terrassilauale 	92	2.1x50	



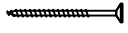

Pos	08.12.2016 Piece list - Stückliste - Liste des pièces - Elementi - Stuklijst - Tükítabel 540x540 AK.1.104.XVV.19d XGC	1/1	Q	P (mm)	L (mm)
	<p data-bbox="261 152 1283 181">Glass size - Glasgröße - Taille de la vitre - Misura del vetro - Glas afmeting - Klaasi mõõt: 382x382 mm</p>   <p data-bbox="1366 349 1490 378">440x440 mm</p>  <p data-bbox="1398 546 1458 575">1,5 mm</p>				
FS1	Window handle fittings - Fenstergriff - Poignee de fenetre - Maniglia c/ferramenta - Raamhendel -/grendel -/klink - Aknalink		1		
FSP	Bolt for window handle fittings - Bolzen für fenstergriff beschlag - Vis pour fixation poignee de fenetre - Bullone x apertura manuale finestra - Schroef voor raamhendel - Akna käepideme polt		2		
HS1	Screw for georgian bars - Schraube für sprossen - Vis pour croisillons - Viti per unire la griglia georgiana della finestra - Schroeven voor raamverdeling - Kruvi akna petfeliistule		4	2.5x20	

Pos	Piece list - Stückliste - Liste des pièces - Elementi - Stuklijst - Tükítabel 14.01.2015 740x1380 UK.2.030.XVP.MM19b XGZ	1/4	Q	P (mm)	L (mm)
	<p>Glass size - Glasgröße - Taille de la vitre - Misura del vetro - Glas afmeting - Klaasi mõõt: 246x246 mm</p>   <p>700x1360 mm</p>  <p>1,5 mm</p>				
	Upper door jamb - Türrahmen oben - Cadre de porte supérieur - Telaio superiore della porta - Bovendorpel - Ukse ülemine leng		1	42x40	740
	Right door jamb - Türrahmen rechts - Cadre de porte droit - Telaio montante destro della porta - Rechterstijl deurframe - Ukse prem leng		1	42x40	1400
	Left door jamb - Türrahmen links - Cadre de porte gauche - Telaio montante sinistro della porta - Linkerstijl deurframe - Ukse vasak leng		1	42x40	1400
	Doorstep - Swelle - Seuil de porte - Callare - Drempel - Lävepakki ukseavale		1	15x21	740
	Fillet - Leiste - Lattes - Massello - Lijst - Liist		2	15x25	276
	Fillet - Leiste - Lattes - Massello - Lijst - Liist		2	15x25	226
	Covering moulding - Deckungsprofil - Profils de finition verticaux a fixer a l'exterieur du cadre de la porte - Cornice di finitura - Afdek profiel - Lengi piirdelaud		1	18x90	780
	Glass - Glas - Vitre - Vetro - Glas - Klaas		1	246x246	
HS2	Screw for window fillet - Schraube für glasteile - Vis de fixation d'encadrement vitrage - Vite per assemblaggio finestra - Schroef voor glaslijst - Kruvi klaasiliistule		8	2.5x25	
HS2	Screw for covering moulding - Schrauben für deckungsprofil - Vis de fixation profils horizontaux haut intérieur et extérieur d'encadrement de porte - Vite per cornice di copertura - Schroef voor afdekprofiel - Kruvi piirdelaud		4	2.5x25	
HS2	Screw for fixing door to the wall - Schraube zur Befestigung für - zarge mit wand - Vis de fixation partie basse dormants de porte au 1er rang de madrier - Viti per fissare la porta alla parete - Schroef voor bevestiging deur naar wand - Kruvi ukseleangi kinnitamiseks seinale		2	3.5x35	



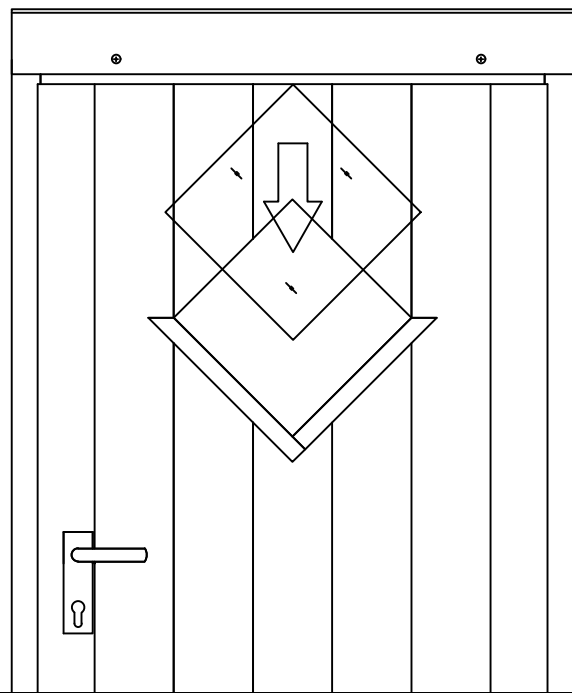
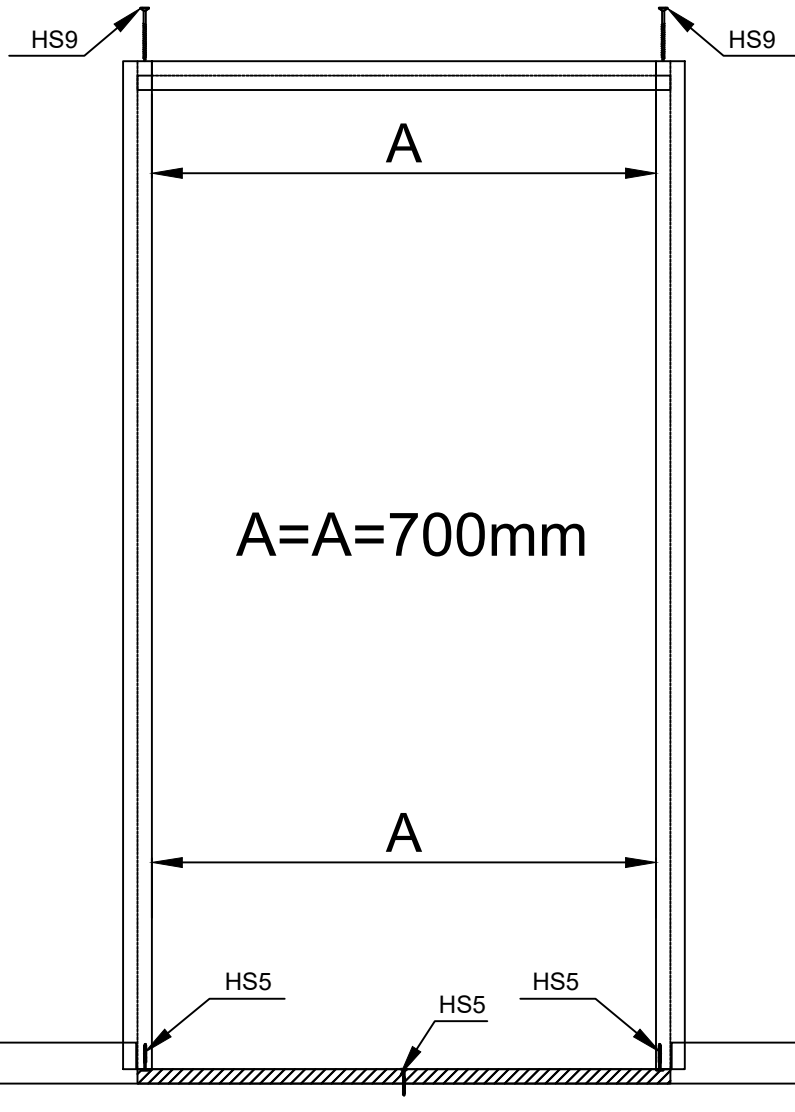

Pos

14.01.2015

Piece list - Stückliste - Liste des pièces - Elementi - Stuklijst - Tükitabel  
740x1380 UK.2.030.XVP.MM19b XGZ

4/4

Q

P  
(mm)

L  
(mm)

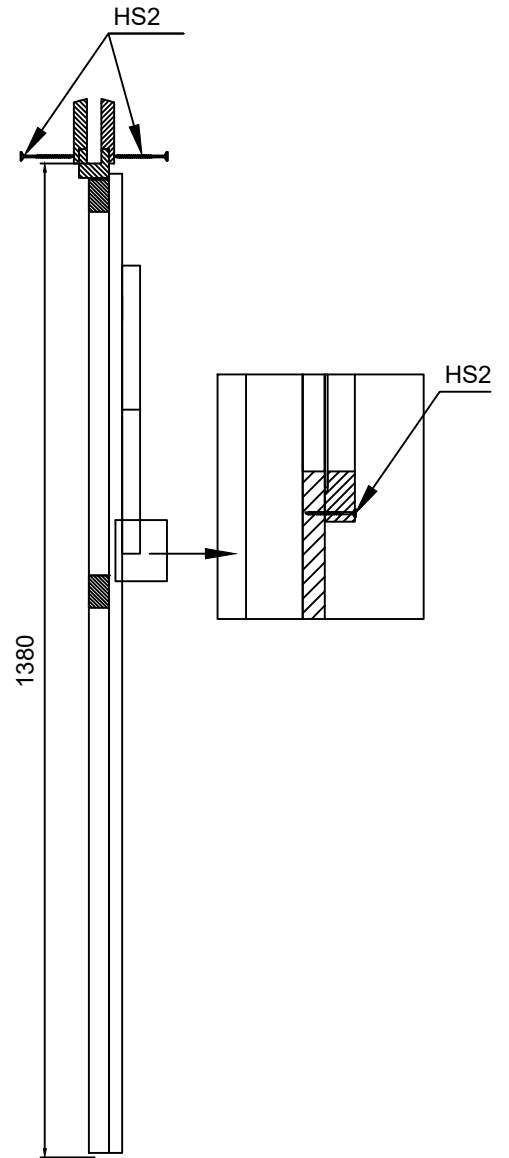
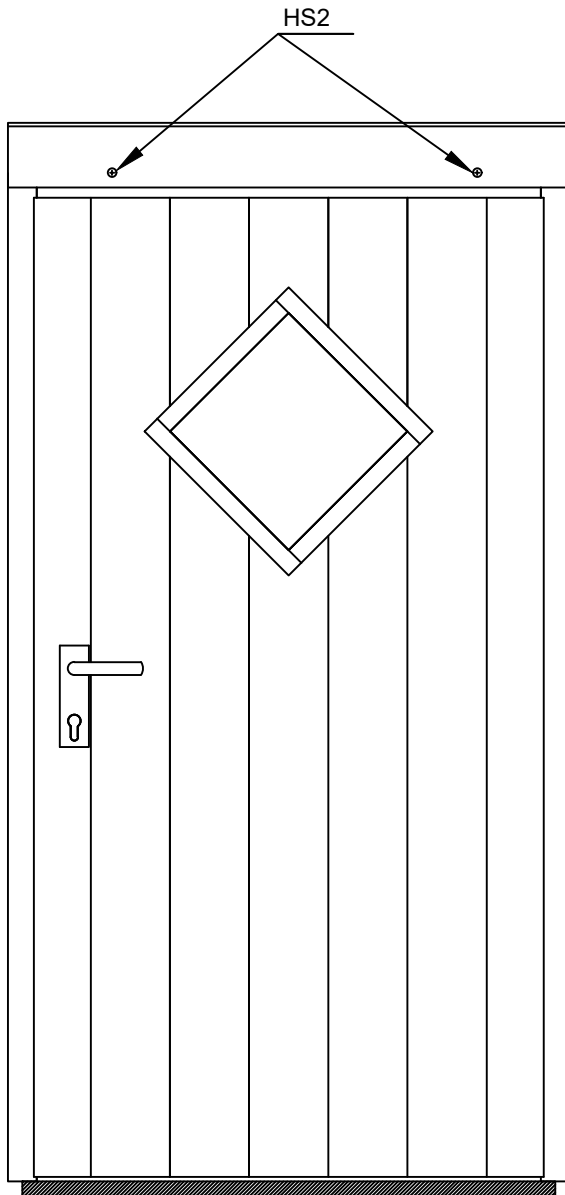

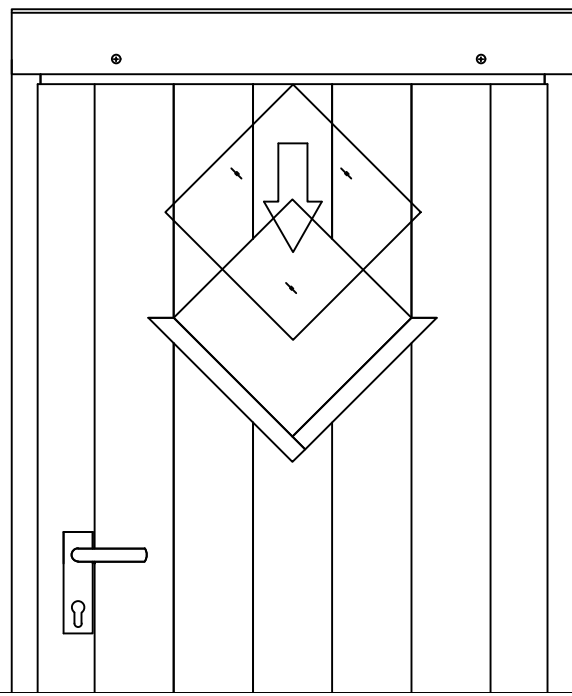
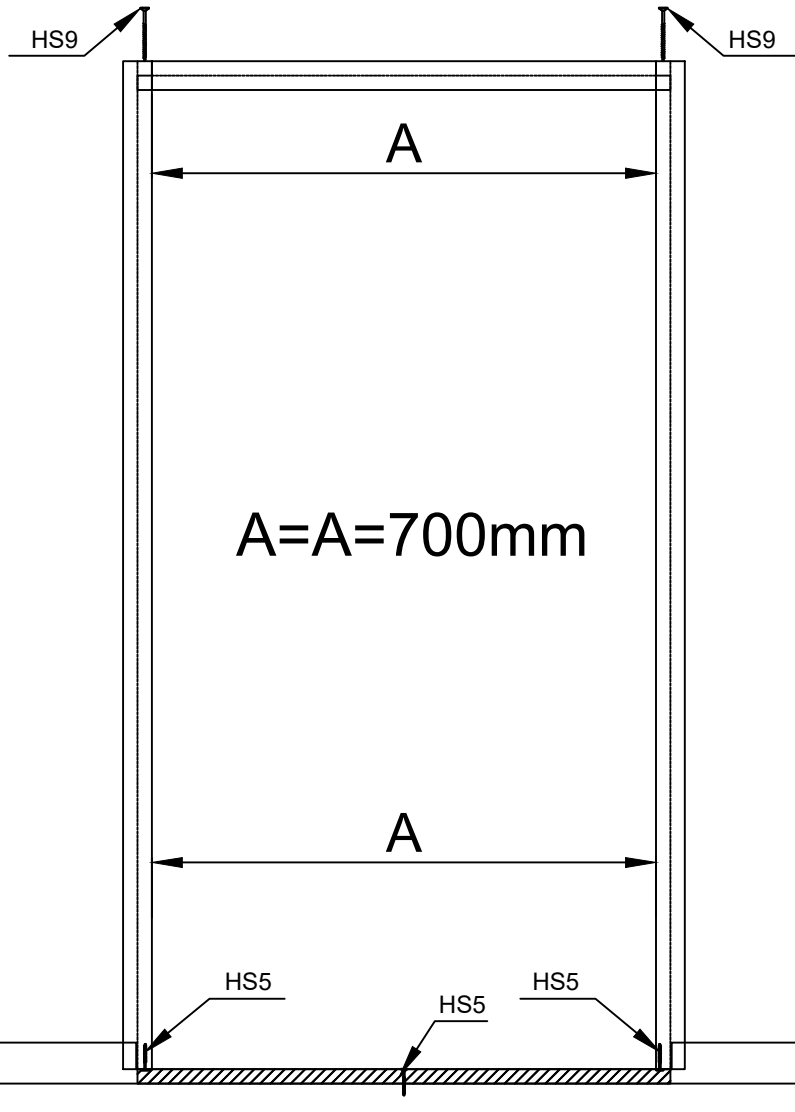

Pos

14.01.2015

Piece list - Stückliste - Liste des pièces - Elementi - Stuklijst - Tükitabel  
740x1380 UK.2.030.XVP.MM19b XGZ

4/4

Q

P  
(mm)

L  
(mm)

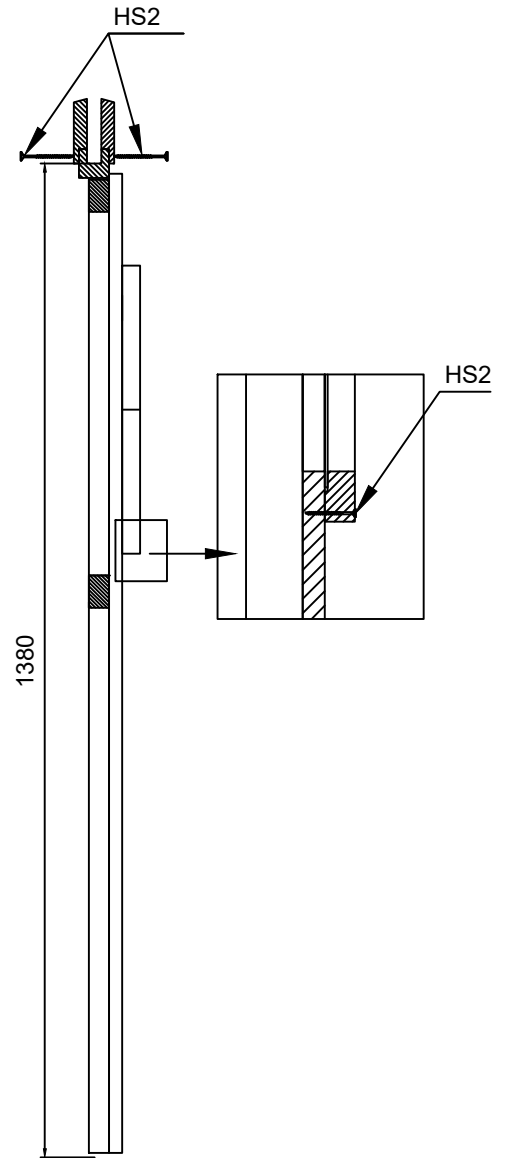
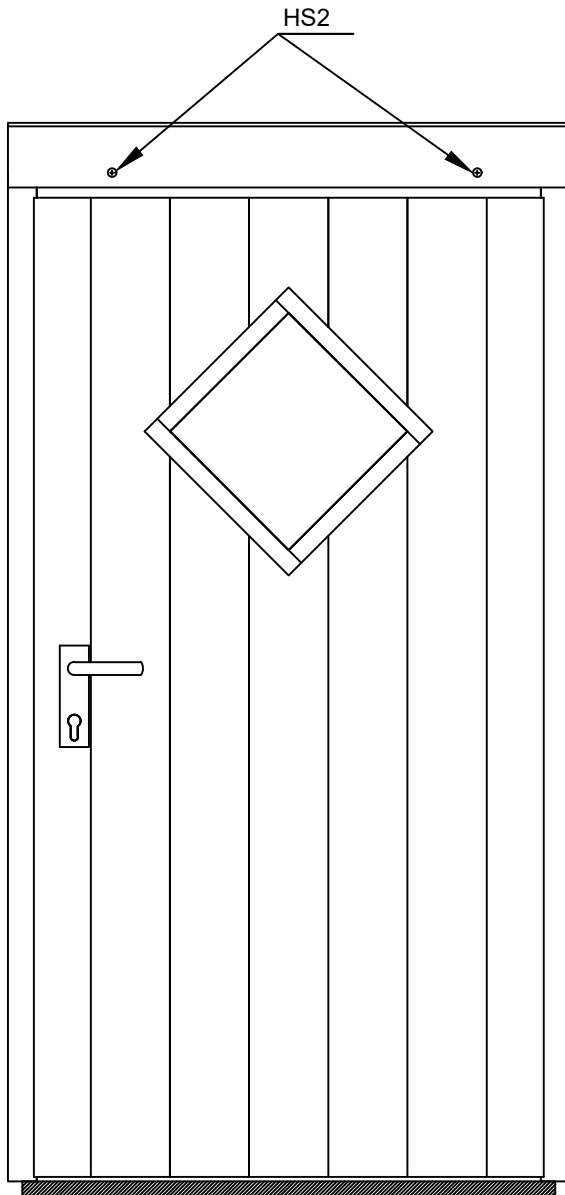

Art. Nr. 199600

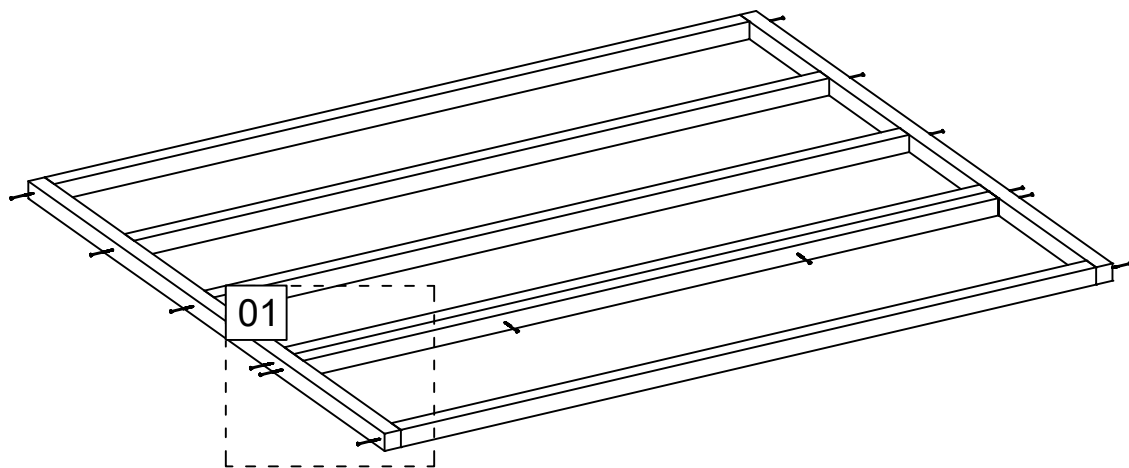

01

HS16

IAR1

IA2

02

TB

HS9

001

007

NF3

03

002

007

NF4

FB

9716

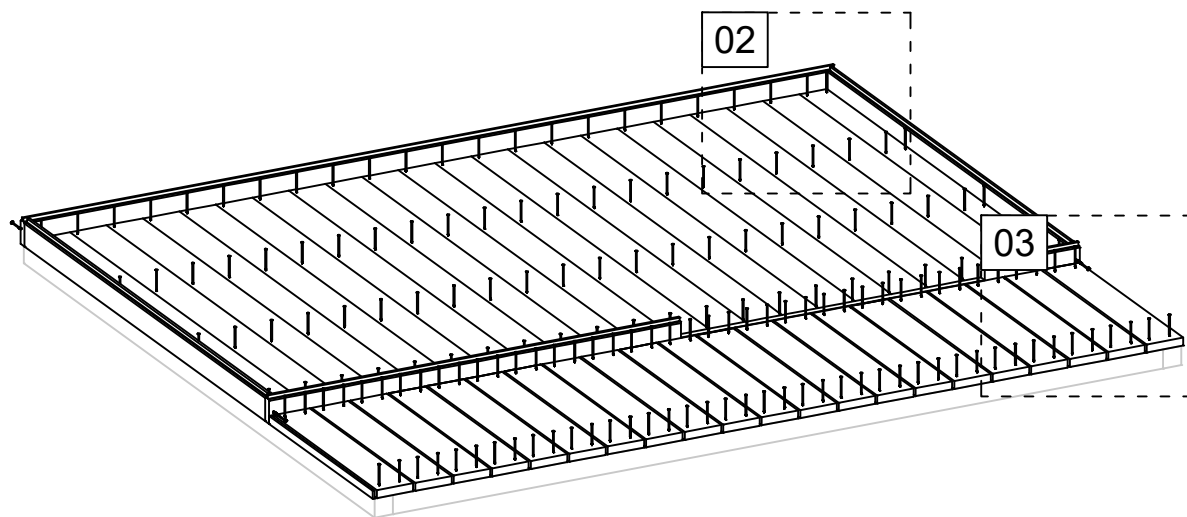

18.02.2022



Art. Nr. 199600

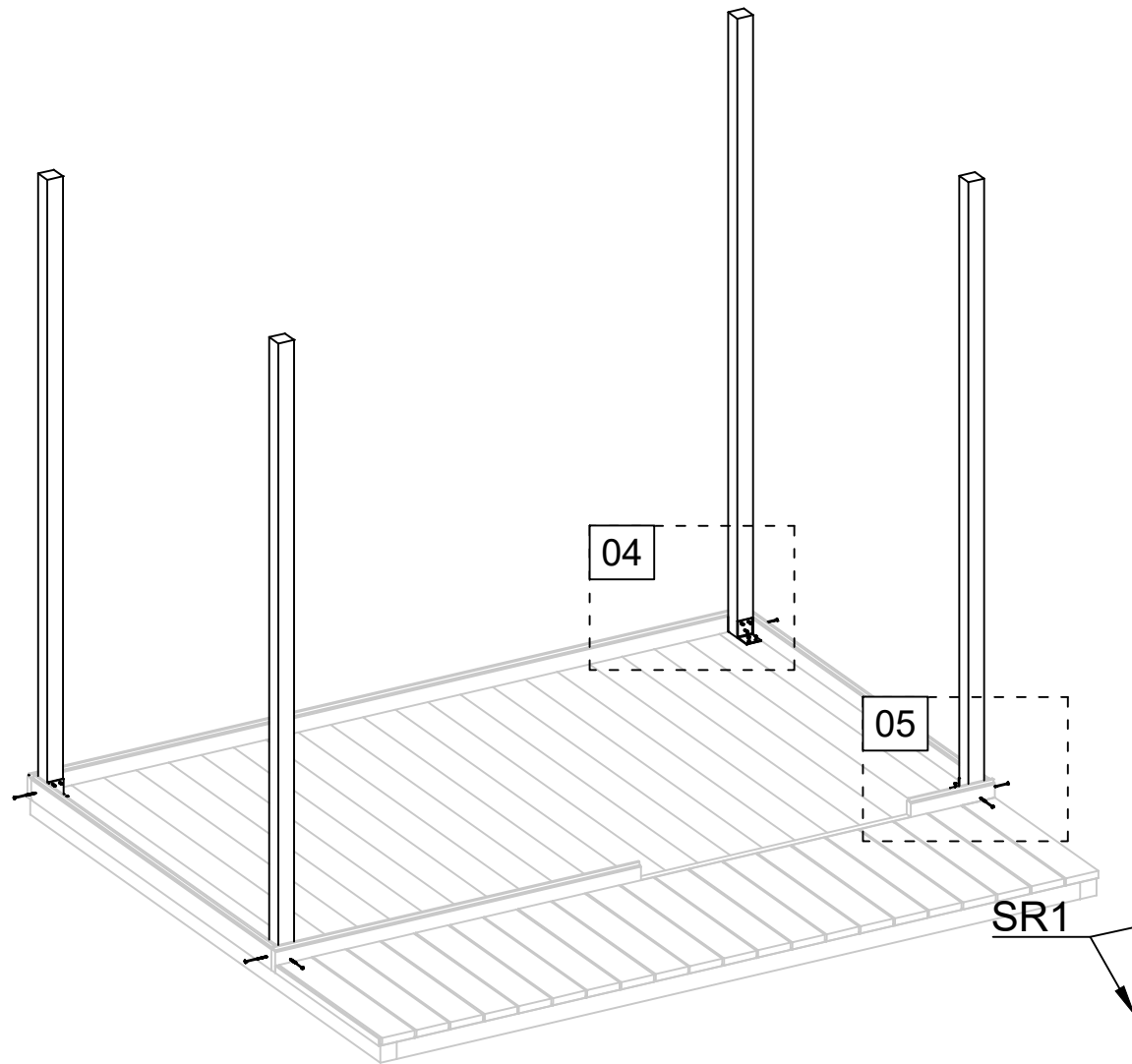

04

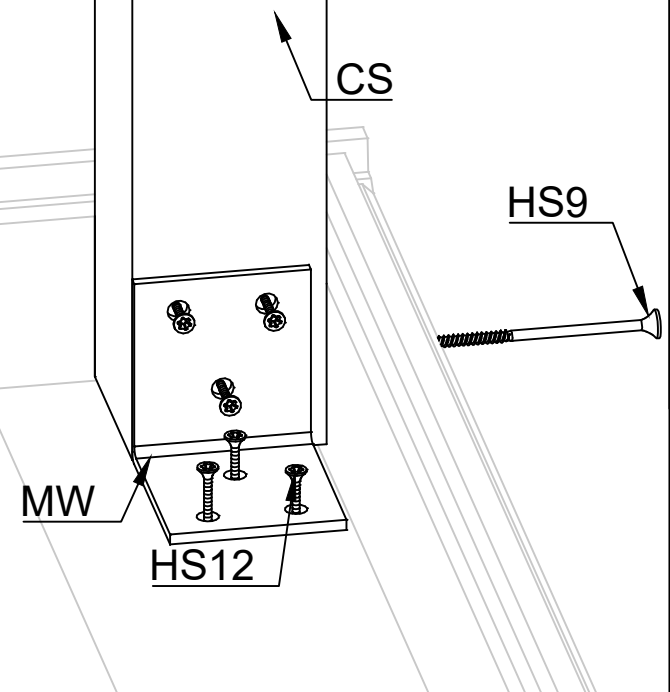

05

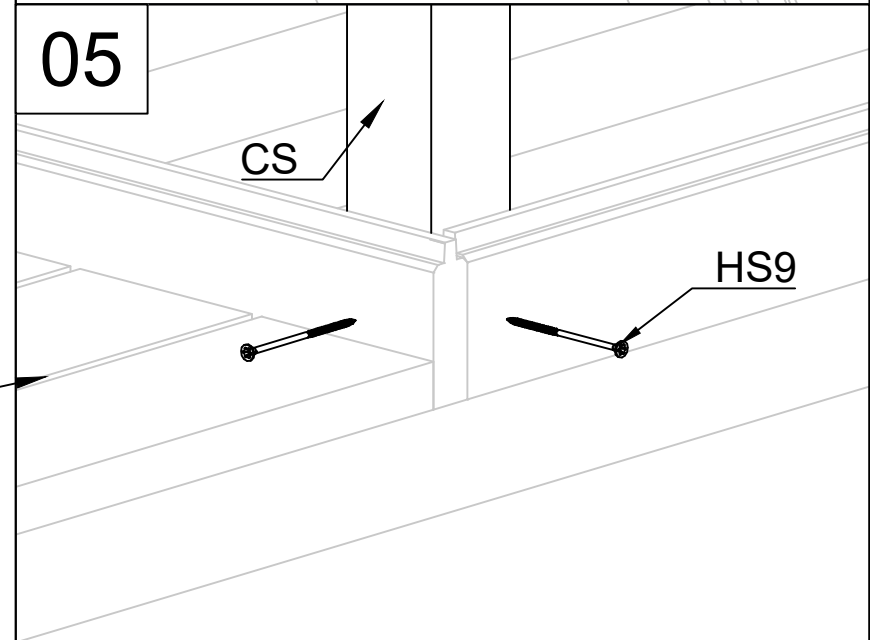

Art. Nr. 199600

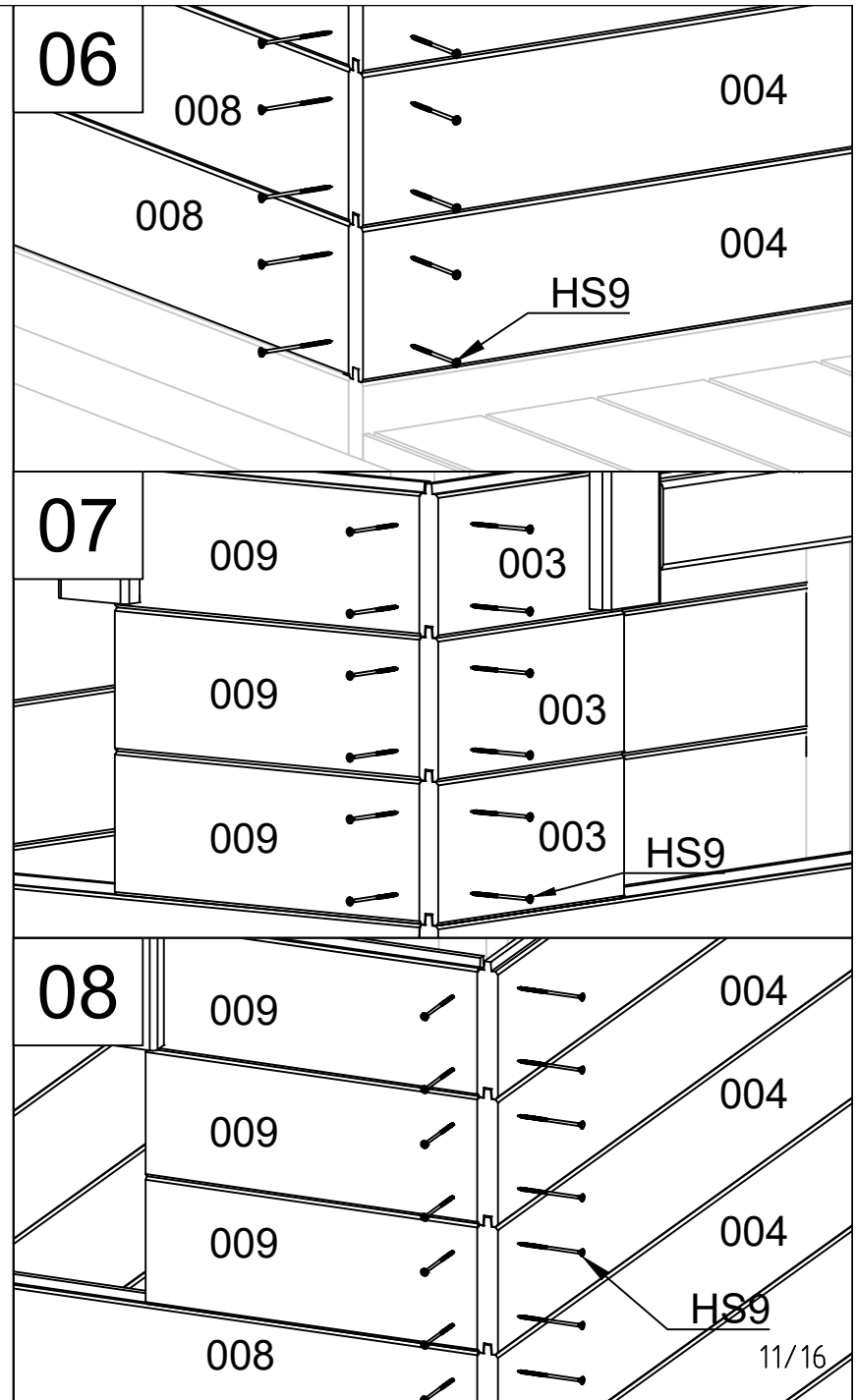
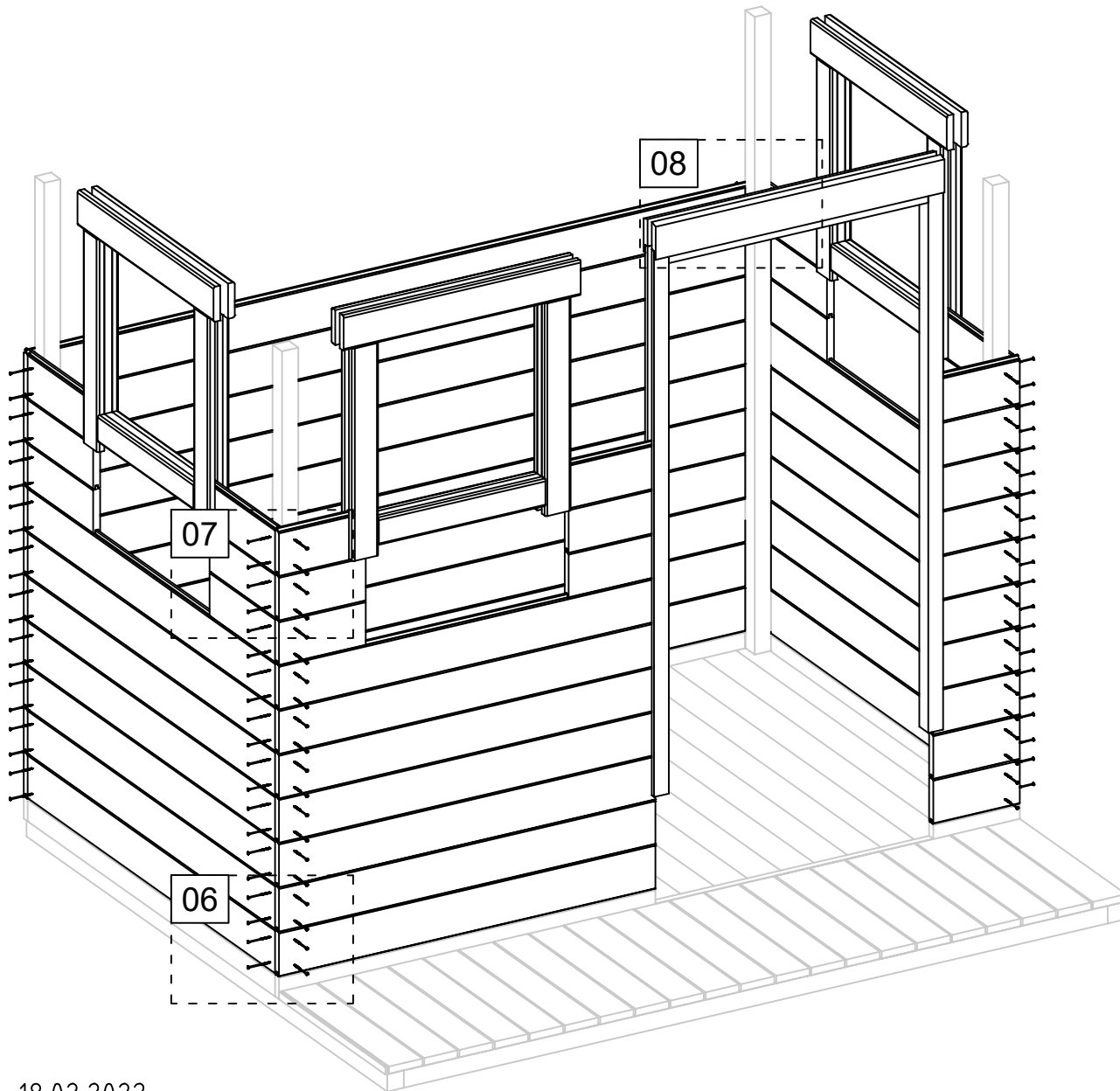

Art. Nr. 199600

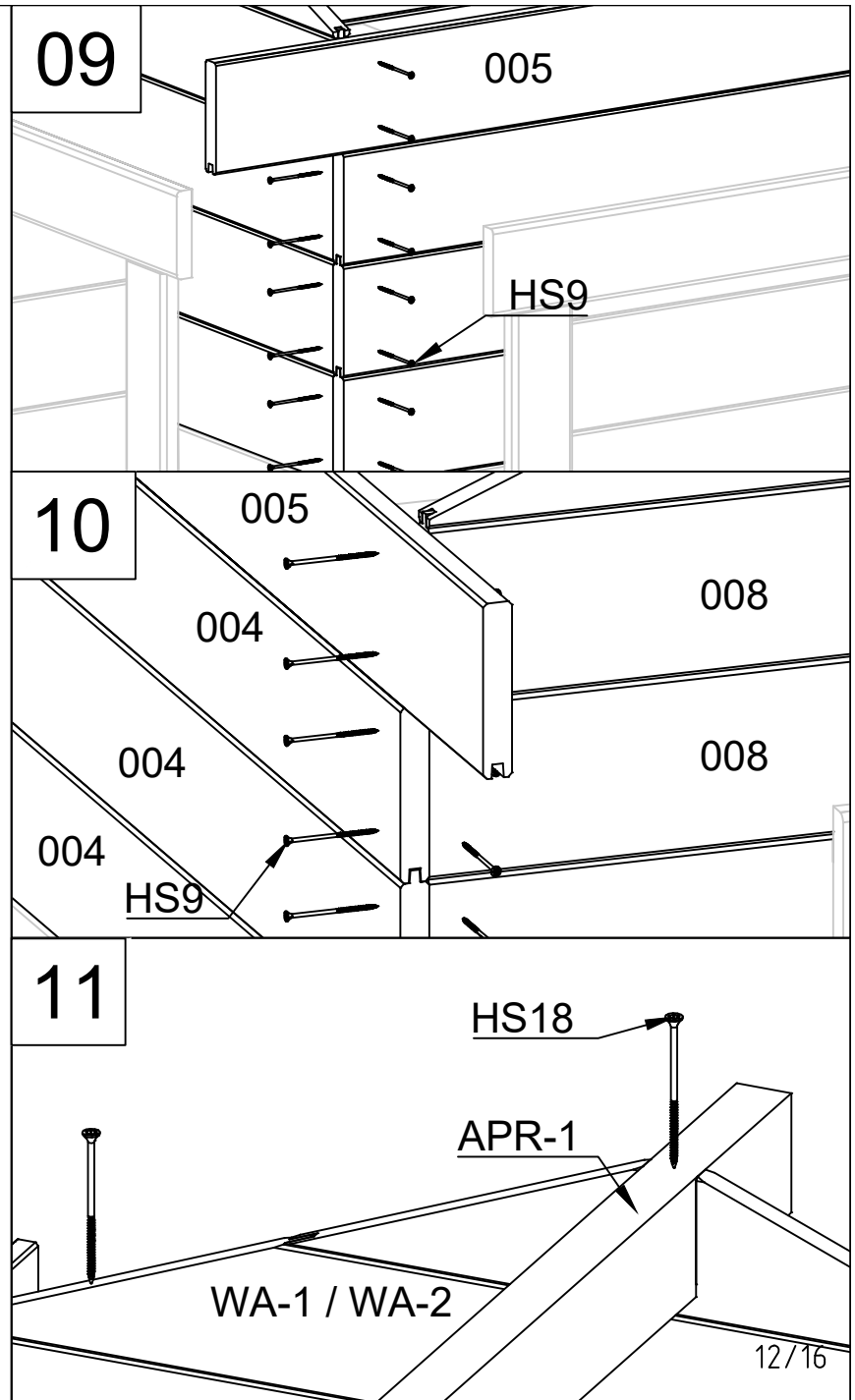
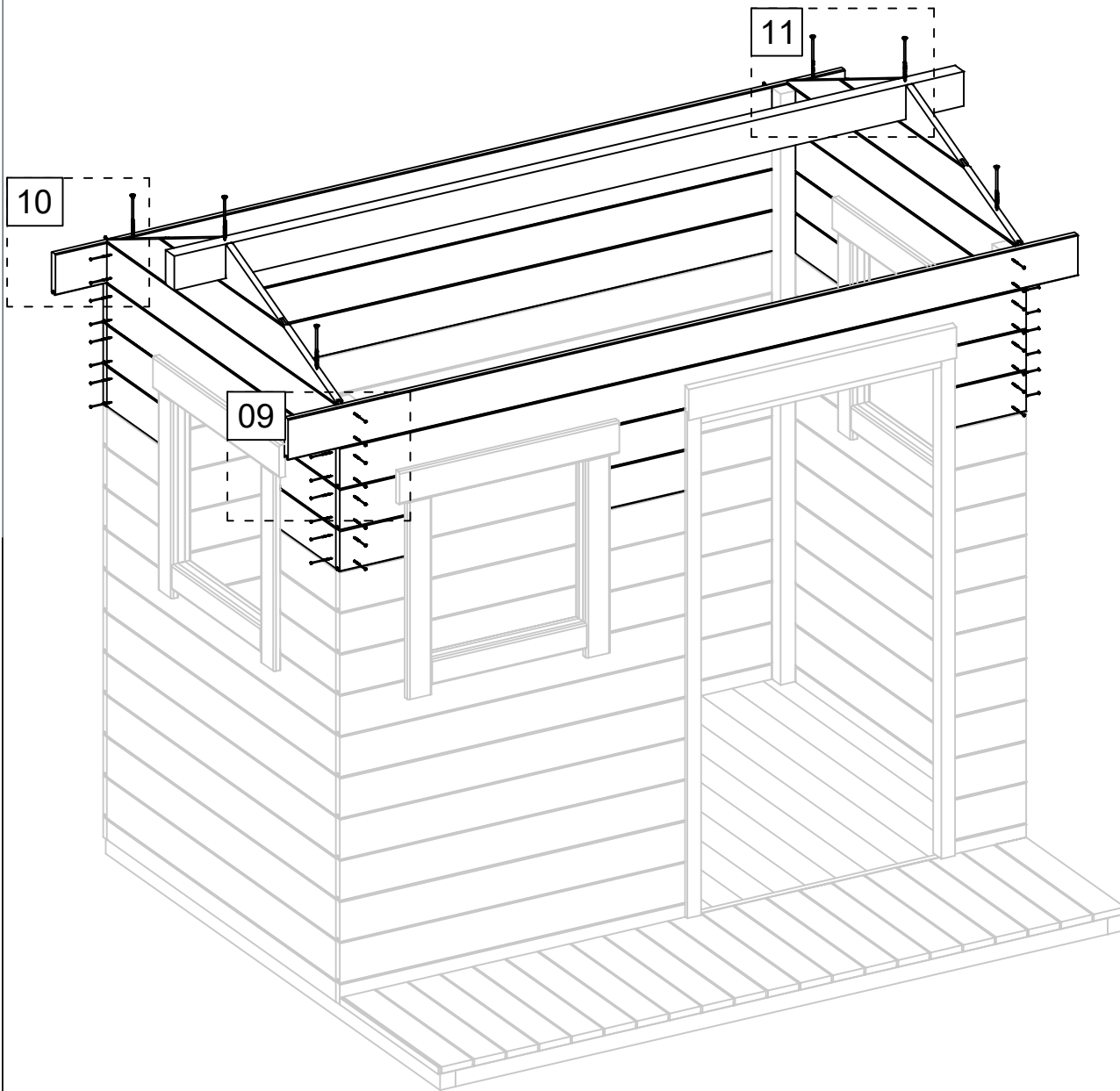

18.02.2022

12/16

Art. Nr. 199600

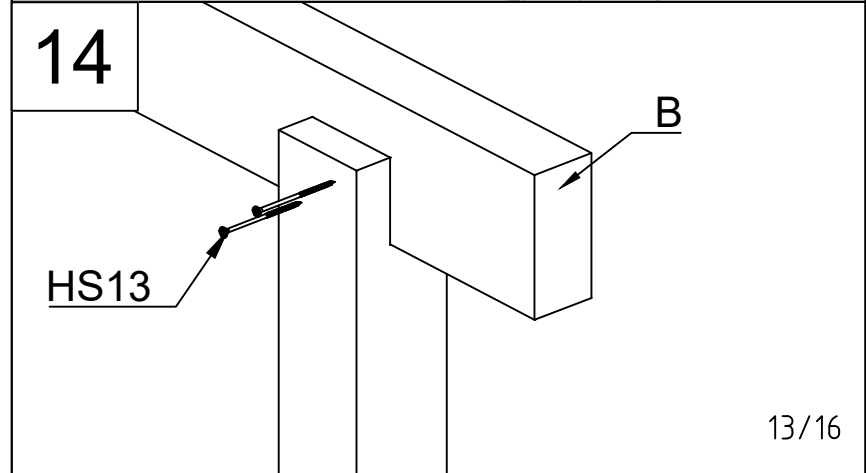
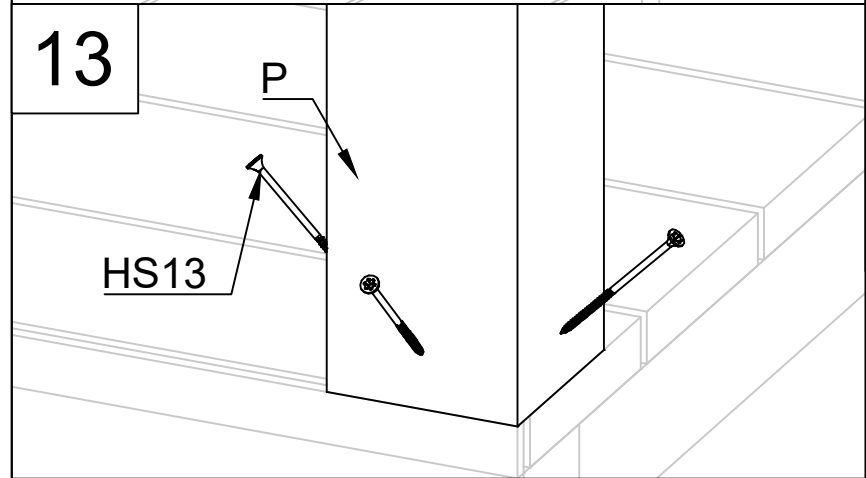
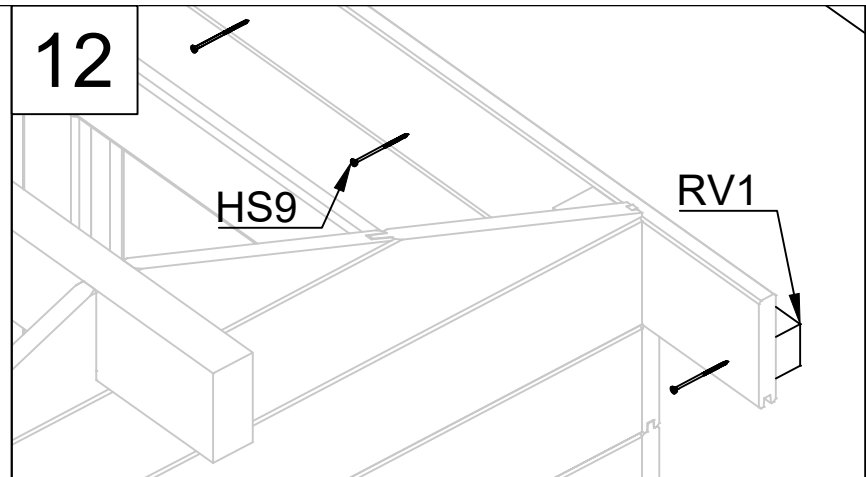
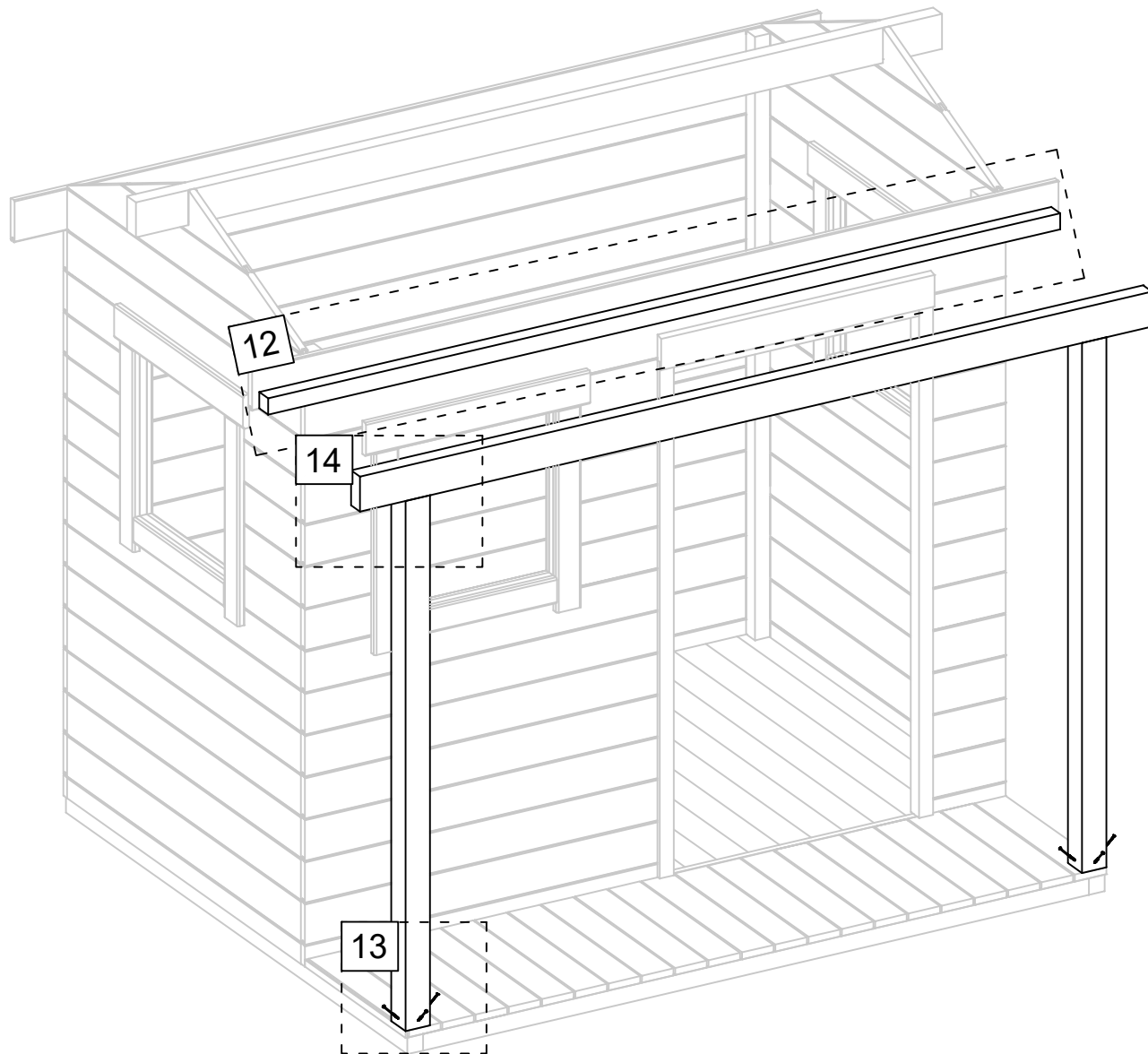

Art. Nr. 199600

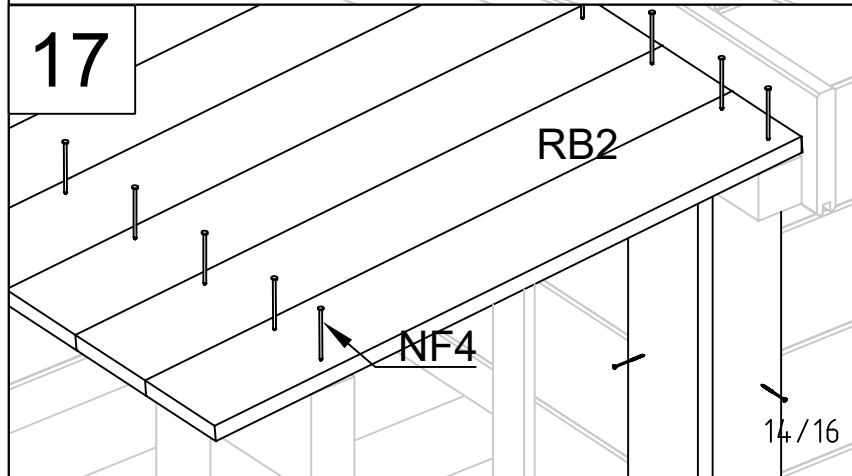
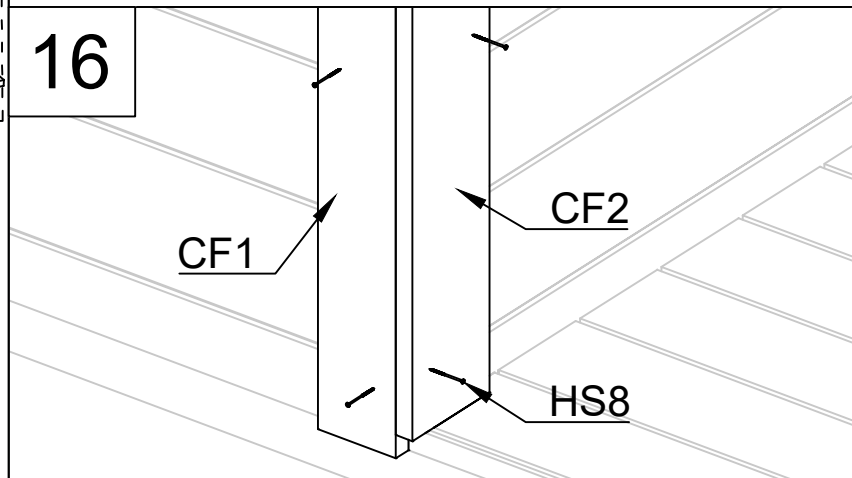
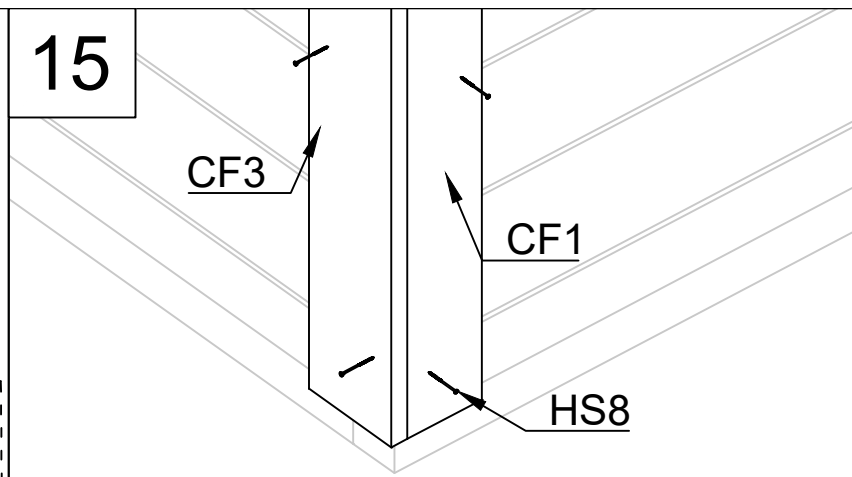
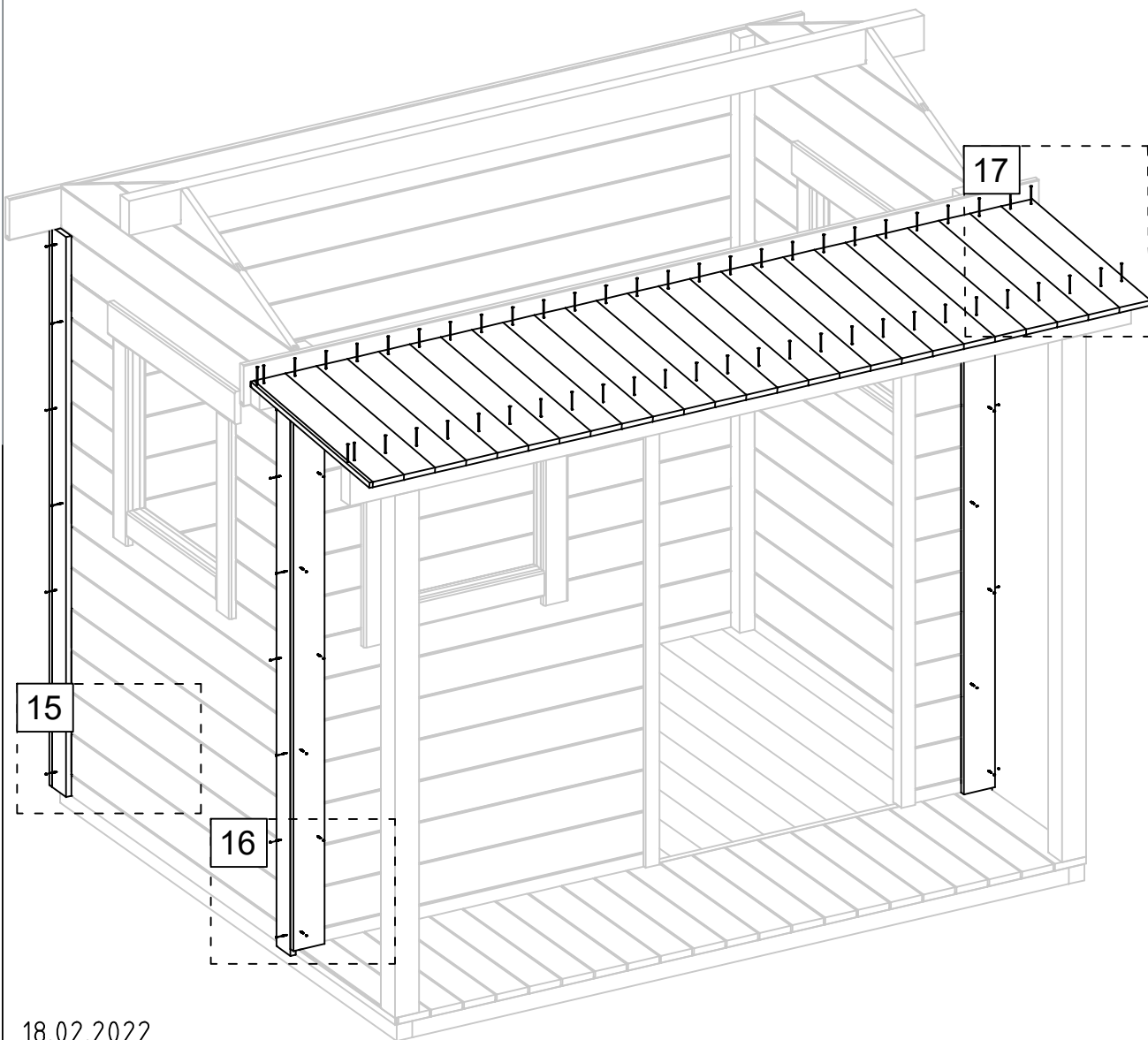

Art. Nr. 199600

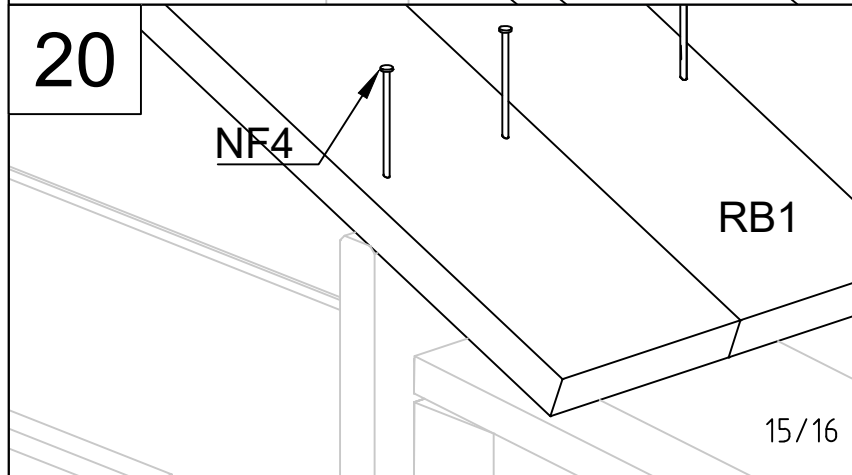
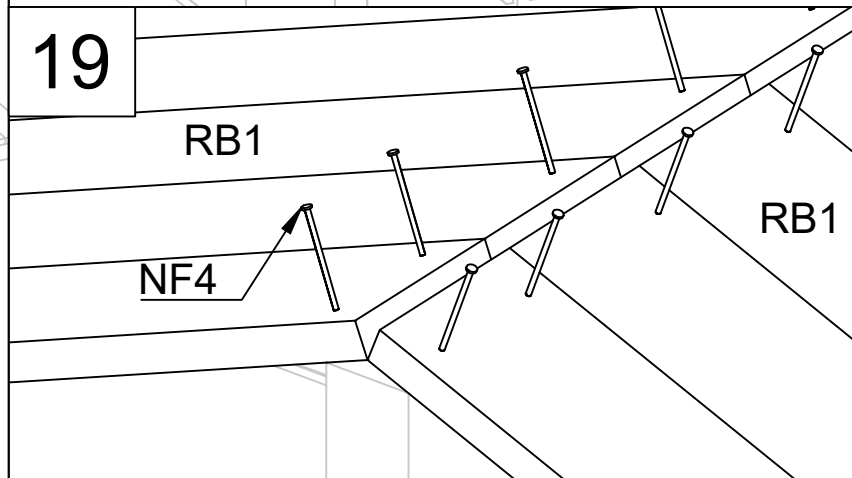
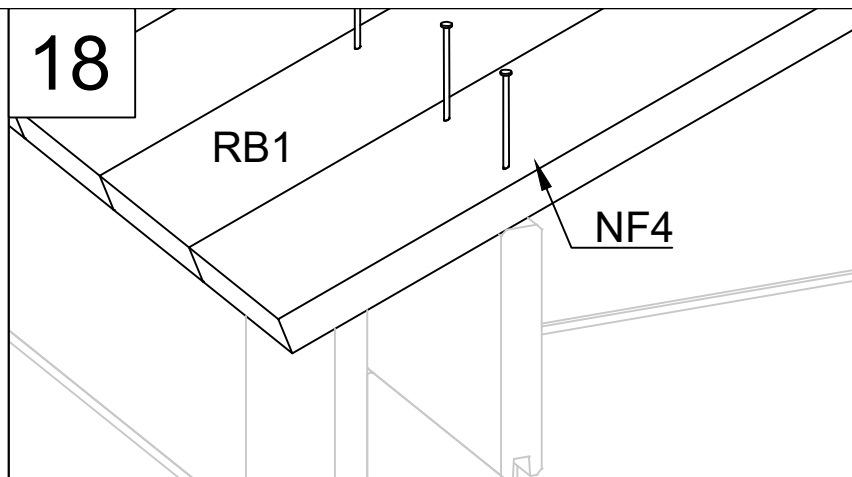
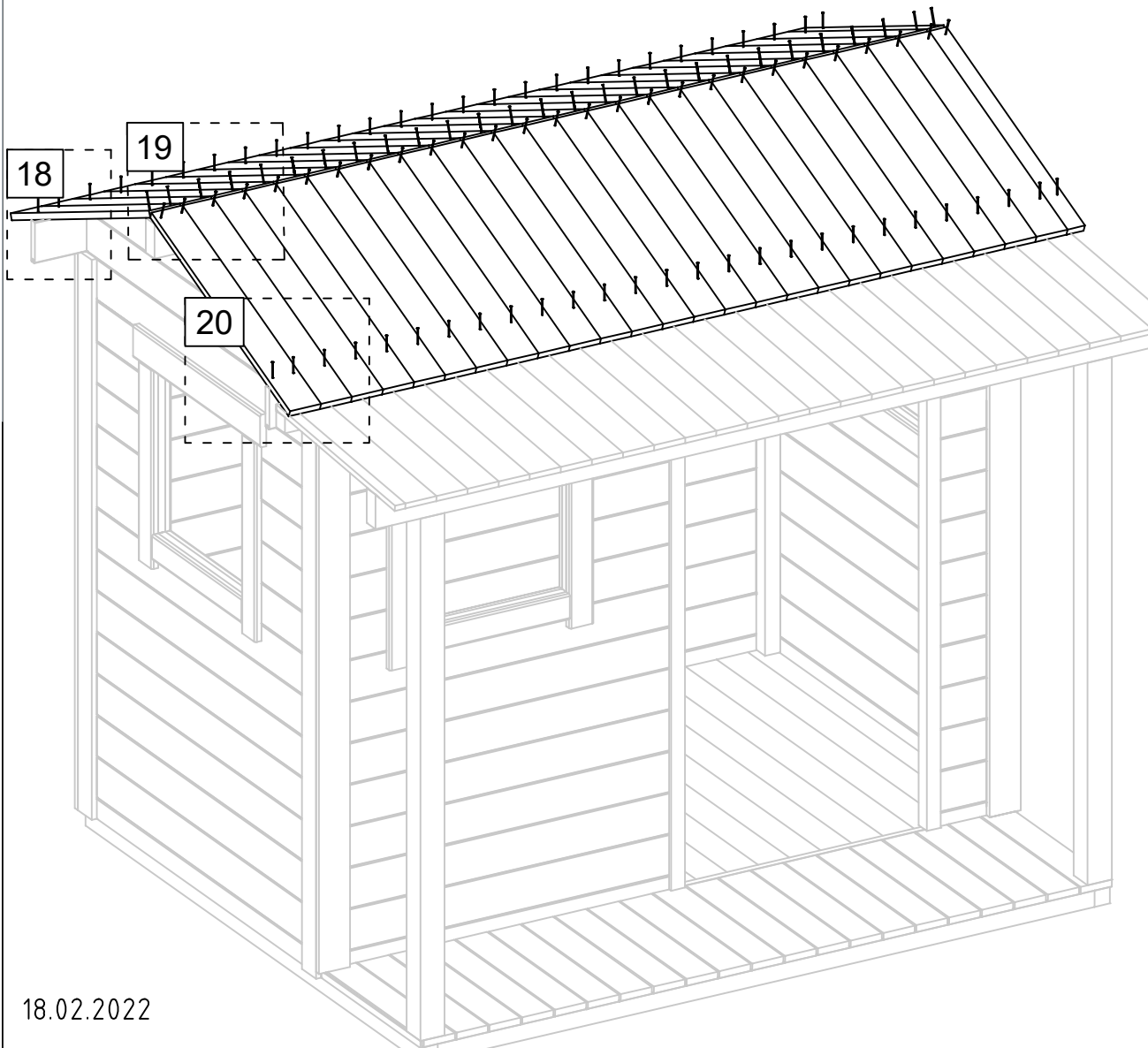

Art. Nr. 199600

